



D

**FERRAGENS
DIVERSAS /**
GENERAL
HARDWARE /
HERRAJES
DIVERSAS.



INDICE / INDEX / INDICE

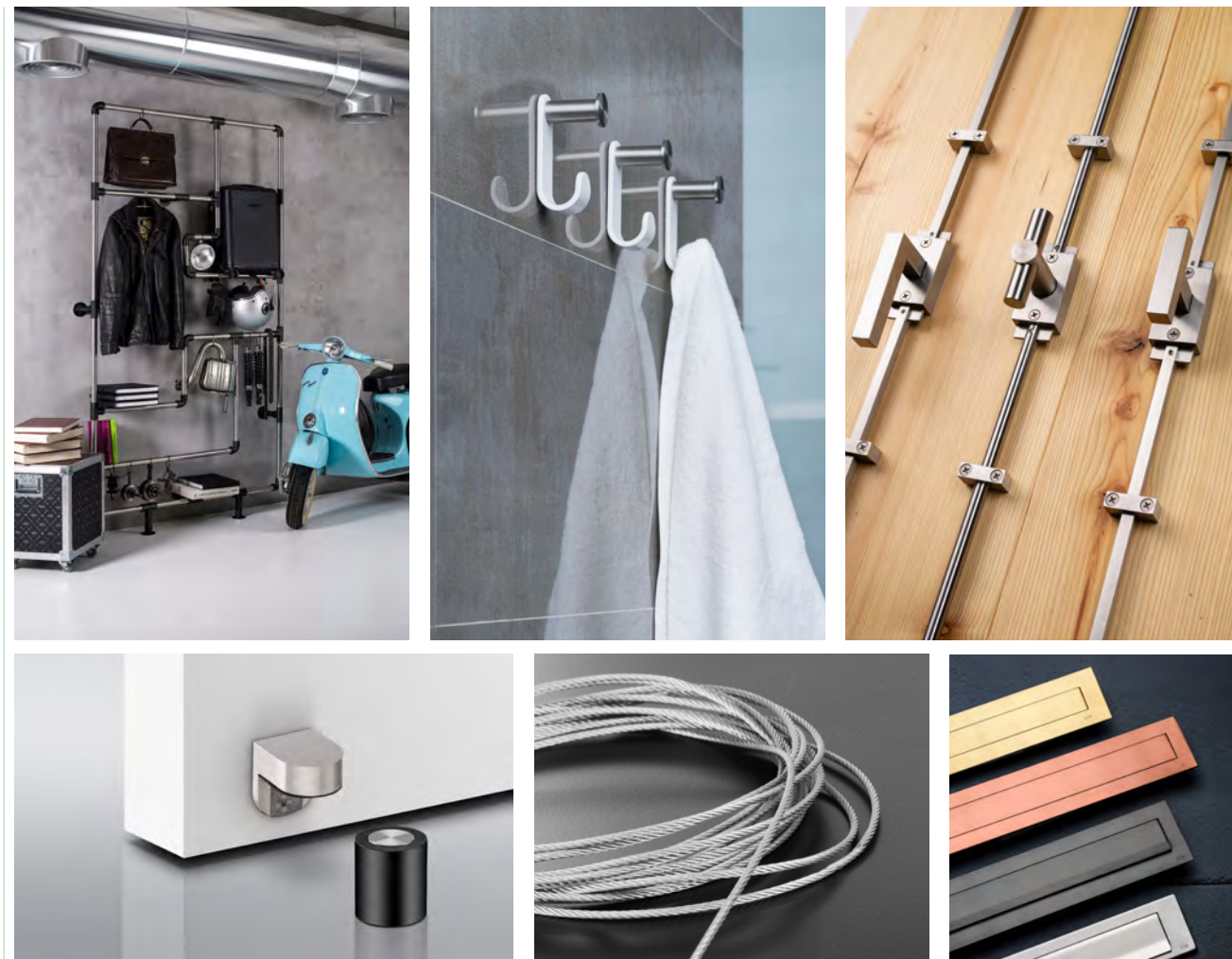

530 **SISTEMAS MODULARES / MODULAR SYSTEMS / SISTEMAS MODULARES**

548 **BATENTES DE PORTA / DOOR STOPPERS / TOPES DE PUERTA**

556 **CABIDES / HOOKS / PERCHAS**

568 **CABIDES E CRUZETAS / HOOKS AND HANGERS / PERCHAS**

570 **SUPORTES DE TUBO / TUBE SUPPORTS / SOPORTES DE TUBO**

572 **FECHOS / BOLTS / CIERRES**

578 **VISORES DE PORTA / DOOR VIEWERS / MIRILLA DE PUERTA**

579 **INTERRUPTORES / SWITCHES / INTERRUPTORES**

580 **SUPORTES DE CORRIMÃO / HAND RAIL SUPPORTS / SOPORTES DE PASAMANOS**

586 **CAIXAS DE CORREIO / MAILBOXES / BUZÓN DE CORREO**

588 **VENTILADORES / VENTILATORS / REJILLAS**

591 **SUPORTES PARA PRATELEIRA / SHELVES SUPPORTS / SOPORTES PARA BANDEJA**

592 **SISTEMA SUSPENSÃO DE MOLDURAS / HANGING FRAMES SYSTEM / SISTEMA DE SUSPÉNCION DE CUADROS**

598 **CABOS DE AÇO / WIRE CABLES / CABLES DE ACERO**



JNF CONNECT SYSTEMS

THINK - CONNECT - BUILD

É um sistema modular para criar estruturas simples, como mobiliário, elementos decorativos, divisórias estruturais, etc.

Os elementos são produzidos em aço inoxidável AISI304 por fundição, o acabamento é RAW, obtendo um aspeto mate e uma sensação suave ao toque. Adicionalmente, estes componentes podem ser produzidos com acabamento pvd em diferentes cores como preto, cobre ou dourado.

O sistema de fixação é muito fácil, apenas com parafusos Allen que garantem o aperto necessário de todos os elementos.

Is a modular system that is used to create easy structures like furniture, decorative elements, structural fences, etc.

The elements are produced in stainless steel AISI 304 by casting, the finish is RAW getting a matte look and a smooth touch feeling. Additionally these components can be produced with PVD finish in different colors like deep black, copper or gold.

The fixing system is very easy, just Allen screws make the necessary tightening of all the elements.

Es un sistema modular para construir estructuras simples, como mobiliario, elementos decorativos, divisiones estructurales, etc.

Los elementos son producidos en acero inoxidable AISI 304 por fundición, el acabado es RAW obteniendo un aspecto mate y una sensación suave al toque. Además, estos componentes se pueden producir con acabado PVD en diferentes colores como negro profundo, cobre o dorado.

El sistema de fijación es muy fácil, sólo tornillos Allen hacen el apriete necesario de todos los elementos.

SISTEMAS MODULARES / MODULAR SYSTEMS / SISTEMAS MODULARES.



IN.09.001
Curva / Elbow / Curva

MATERIAL: EN 1.4301 / AISI 304

ACABAMENTO / FINISH: RAW

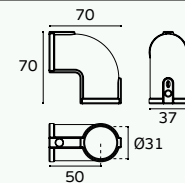

IN.09.002
União / Union / Unión

MATERIAL: EN 1.4301 / AISI 304

ACABAMENTO / FINISH: RAW

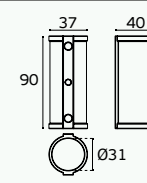

IN.09.003
Conector / Connector / Conector

MATERIAL: EN 1.4301 / AISI 304

ACABAMENTO / FINISH: RAW

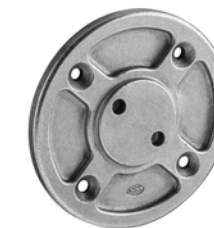
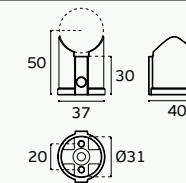

IN.09.004
Base / Base / Base

MATERIAL: EN 1.4301 / AISI 304

ACABAMENTO / FINISH: RAW

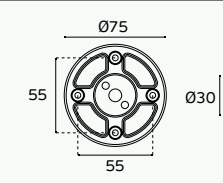

IN.09.005.1
Conector / Connector / Conector

MATERIAL: EN 1.4301 / AISI 304

ACABAMENTO / FINISH: RAW

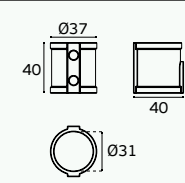

IN.09.010
União / Union / Unión

MATERIAL: EN 1.4301 / AISI 304

ACABAMENTO / FINISH: RAW

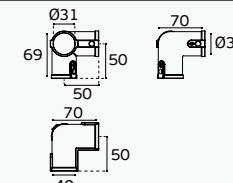

IN.09.011
União / Union / Unión

MATERIAL: EN 1.4301 / AISI 304

ACABAMENTO / FINISH: RAW

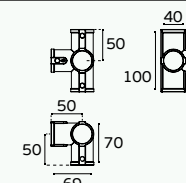

IN.09.012
União / Union / Unión

MATERIAL: EN 1.4301 / AISI 304

ACABAMENTO / FINISH: RAW

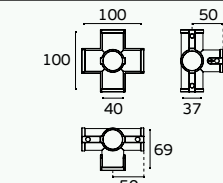

IN.23.600.30.1000
IN.23.600.30.2000
IN.23.600.30.3000
Tubo / Tube / Tubo

MATERIAL: EN 1.4301 / AISI 304

ACABAMENTO / FINISH: RAW

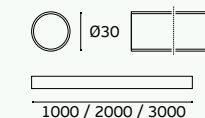

IN.09.004.1
Tampa de remate / Finishing cap / Cubierta de remate

MATERIAL: EN 1.4301 / AISI 304

ACABAMENTO / FINISH: RAW

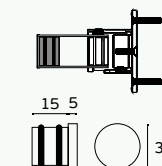

IN.09.008
Reforço interior de tubo / Inner tube reinforcement / Refuerzo interior de tubo.

MATERIAL: ALUMINIO / ALUMINIUM

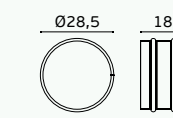

IN.09.006
Base interior de fixação / Inner fixing base / Base interior fijación

MATERIAL: ALUMINIO / ALUMINIUM



IN.09.007
Base interior de fixação / Inner fixing base / Base interior fijación

MATERIAL: ALUMINIO / ALUMINIUM

SISTEMAS MODULARES /
MODULAR SYSTEMS / SISTEMAS MODULARES.



IN.09.001.TB
Curva / Elbow / Curva

MATERIAL: EN 1.4301 / AISI 304

ACABAMENTO / FINISH : RAW

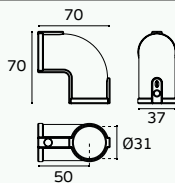

IN.09.002.TB
União / Union / Unión

MATERIAL: EN 1.4301 / AISI 304

ACABAMENTO / FINISH : RAW

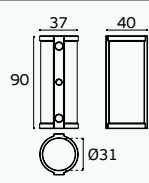

IN.09.003.TB
Conector / Connector / Conector

MATERIAL: EN 1.4301 / AISI 304

ACABAMENTO / FINISH : RAW

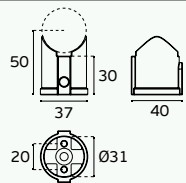

IN.09.004.TB
Base / Base / Base

MATERIAL: EN 1.4301 / AISI 304

ACABAMENTO / FINISH : RAW

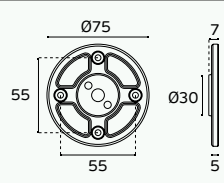

.P
Mirror
finish

.TB
PVD
Titanium
black

.TG
PVD
Titanium
gold

.TCO
PVD
Titanium
copper

.TCH
PVD
Titanium
chocolate



IN.09.005.1.TB
Conector / Connector / Conector

MATERIAL: EN 1.4301 / AISI 304

ACABAMENTO / FINISH : RAW

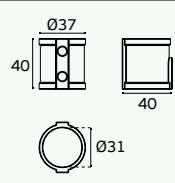

IN.09.010.TB
União / Union / Unión

MATERIAL: EN 1.4301 / AISI 304

ACABAMENTO / FINISH : RAW

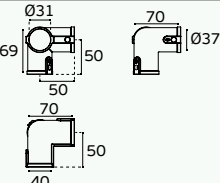

IN.09.011.TB
União / Union / Unión

MATERIAL: EN 1.4301 / AISI 304

ACABAMENTO / FINISH : RAW

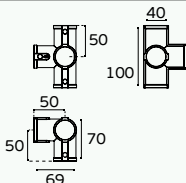

IN.09.012.TB
União / Union / Unión

MATERIAL: EN 1.4301 / AISI 304

ACABAMENTO / FINISH : RAW

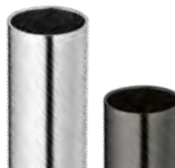
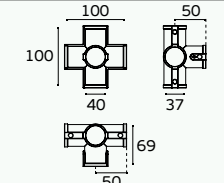

IN.23.600.30.1000.TB
IN.23.600.30.2000.TB
IN.23.600.30.3000
Tubo / Tube / Tubo

MATERIAL: EN 1.4301 / AISI 304

ACABAMENTO / FINISH : RAW

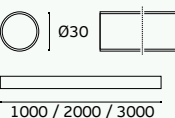

IN.09.004.1.TB
Tampa de remate /
Finishing cap /
Cubierta de remate

MATERIAL: EN 1.4301 / AISI 304

ACABAMENTO / FINISH : RAW

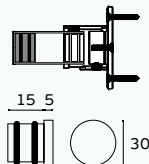

IN.09.008
Reforço interior de tubo /
Inner tube reinforcement /
Refuerzo interior de tubo.

MATERIAL: ALUMINIO / ALUMINIUM

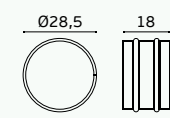

IN.09.006
Base interior de fixação /
Inner fixing base / Base interior fijación

MATERIAL: ALUMINIO / ALUMINIUM



IN.09.007
Base interior de fixação /
Inner fixing base / Base interior fijación

MATERIAL: ALUMINIO / ALUMINIUM



SISTEMAS MODULARES /
MODULAR SYSTEMS /
SISTEMAS MODULARES.



.P
Mirror
finish

.TB
PVD
Titanium
black

.TG
PVD
Titanium
gold

.TCO
PVD
Titanium
copper

.TCH
PVD
Titanium
chocolate



IN.09.001.TG
Curva / Elbow / Curva

MATERIAL: EN 1.4301 / AISI 304

ACABAMENTO / FINISH: RAW

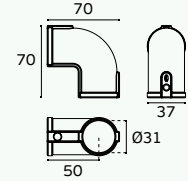

IN.09.002.TG
União / Union / Unión

MATERIAL: EN 1.4301 / AISI 304

ACABAMENTO / FINISH: RAW

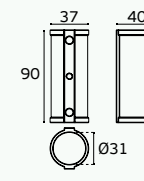

IN.09.003.TG
Conector / Connector / Conector

MATERIAL: EN 1.4301 / AISI 304

ACABAMENTO / FINISH: RAW

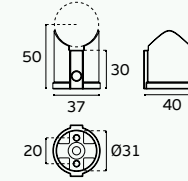

IN.09.004.TG
Base / Base / Base

MATERIAL: EN 1.4301 / AISI 304

ACABAMENTO / FINISH: RAW

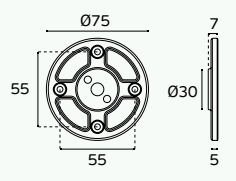

IN.09.005.1.TG
Conector / Connector / Conector

MATERIAL: EN 1.4301 / AISI 304

ACABAMENTO / FINISH: RAW

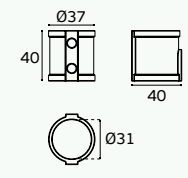

IN.09.010.TG
União / Union / Unión

MATERIAL: EN 1.4301 / AISI 304

ACABAMENTO / FINISH: RAW

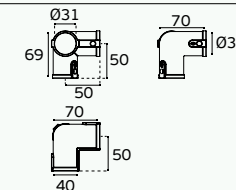

IN.09.011.TG
União / Union / Unión

MATERIAL: EN 1.4301 / AISI 304

ACABAMENTO / FINISH: RAW

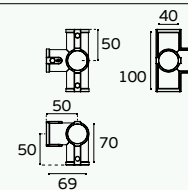

IN.09.012.TG
União / Union / Unión

MATERIAL: EN 1.4301 / AISI 304

ACABAMENTO / FINISH: RAW

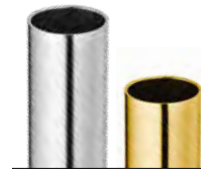
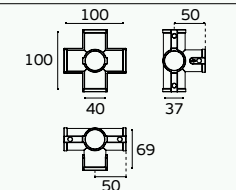

IN.23.600.30.1000.TG
IN.23.600.30.2000.TG
IN.23.600.30.3000
Tubo / Tube / Tubo

MATERIAL: EN 1.4301 / AISI 304

ACABAMENTO / FINISH: RAW

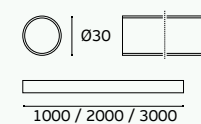

IN.09.004.1.TG
Tampa de remate /
Finishing cap /
Cubierta de remate

MATERIAL: EN 1.4301 / AISI 304

ACABAMENTO / FINISH: RAW

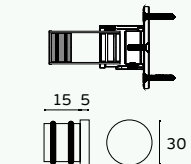

IN.09.008
Reforço interior de tubo /
Inner tube reinforcement /
Refuerzo interior de tubo.

MATERIAL: ALUMINIO / ALUMINIUM

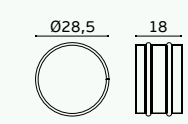

IN.09.006
Base interior de fixação /
Inner fixing base / Base interior fijación

MATERIAL: ALUMINIO / ALUMINIUM



IN.09.007
Base interior de fixação /
Inner fixing base / Base interior fijación

MATERIAL: ALUMINIO / ALUMINIUM

SISTEMAS MODULARES / MODULAR SYSTEMS / SISTEMAS MODULARES.



IN.09.001.TCO
Curva / Elbow / Curva

MATERIAL: EN 1.4301 / AISI 304

ACABAMENTO / FINISH: RAW

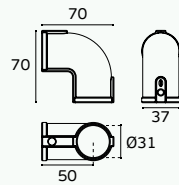

IN.09.002.TCO
União / Union / Unión

MATERIAL: EN 1.4301 / AISI 304

ACABAMENTO / FINISH: RAW

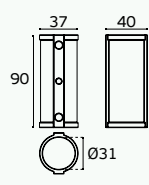

IN.09.003.TCO
Conector / Connector / Conector

MATERIAL: EN 1.4301 / AISI 304

ACABAMENTO / FINISH: RAW

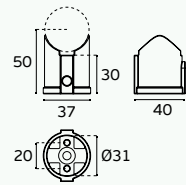

IN.09.004.TCO
Base / Base / Base

MATERIAL: EN 1.4301 / AISI 304

ACABAMENTO / FINISH: RAW

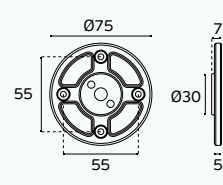

.P
Mirror finish

.TB
PVD Titanium black

.TG
PVD Titanium gold

.TCO
PVD Titanium copper

.TCH
PVD Titanium chocolate



IN.09.005.1.TCO
Conector / Connector / Conector

MATERIAL: EN 1.4301 / AISI 304

ACABAMENTO / FINISH: RAW

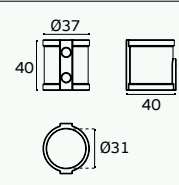

IN.09.010.TCO
União / Union / Unión

MATERIAL: EN 1.4301 / AISI 304

ACABAMENTO / FINISH: RAW

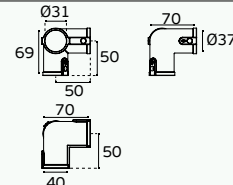

IN.09.011.TCO
União / Union / Unión

MATERIAL: EN 1.4301 / AISI 304

ACABAMENTO / FINISH: RAW

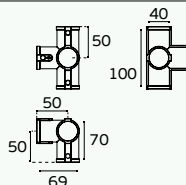

IN.09.012.TCO
União / Union / Unión

MATERIAL: EN 1.4301 / AISI 304

ACABAMENTO / FINISH: RAW

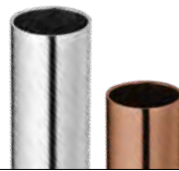
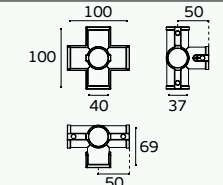

IN.23.600.30.1000.TCO
IN.23.600.30.2000.TCO
IN.23.600.30.3000
Tubo / Tube / Tubo

MATERIAL: EN 1.4301 / AISI 304

ACABAMENTO / FINISH: RAW

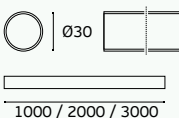

IN.09.004.1.TCO
Tampa de remate / Finishing cap / Cubierta de remate

MATERIAL: EN 1.4301 / AISI 304

ACABAMENTO / FINISH: RAW

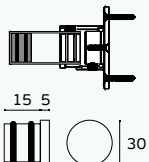

IN.09.008
Reforço interior de tubo / Inner tube reinforcement / Refuerzo interior de tubo.

MATERIAL: ALUMINIO / ALUMINIUM

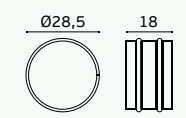

IN.09.006
Base interior de fixação / Inner fixing base / Base interior fijación

MATERIAL: ALUMINIO / ALUMINIUM



IN.09.007
Base interior de fixação / Inner fixing base / Base interior fijación

MATERIAL: ALUMINIO / ALUMINIUM



SISTEMAS MODULARES / MODULAR SYSTEMS / SISTEMAS MODULARES.



IN.09.004 + IN.09.003 + IN.09.002

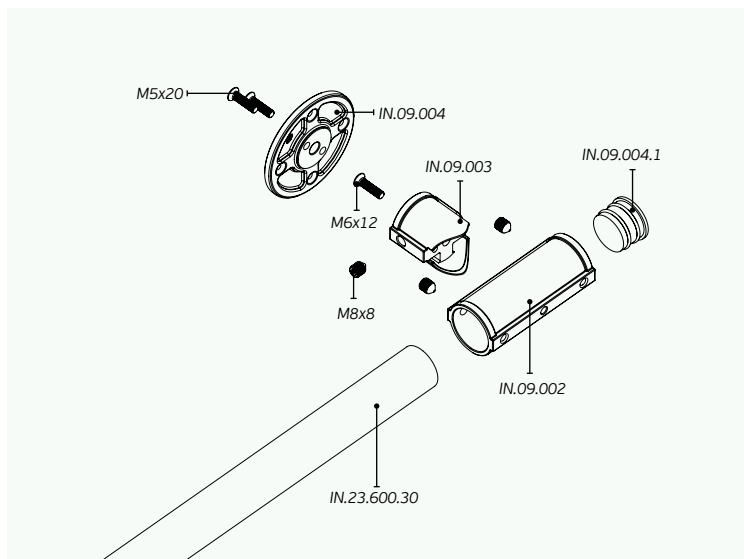

IN.09.004 + IN.09.001

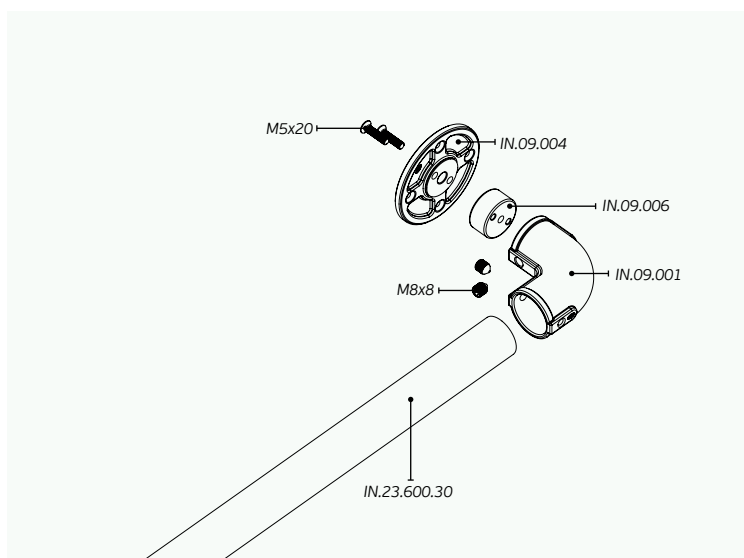

IN.09.004 + IN.09.005

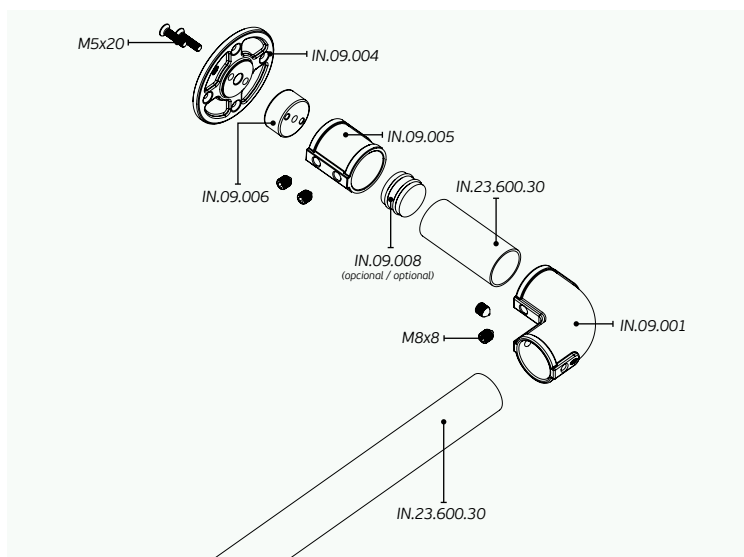

IN.09.004 + IN.09.010

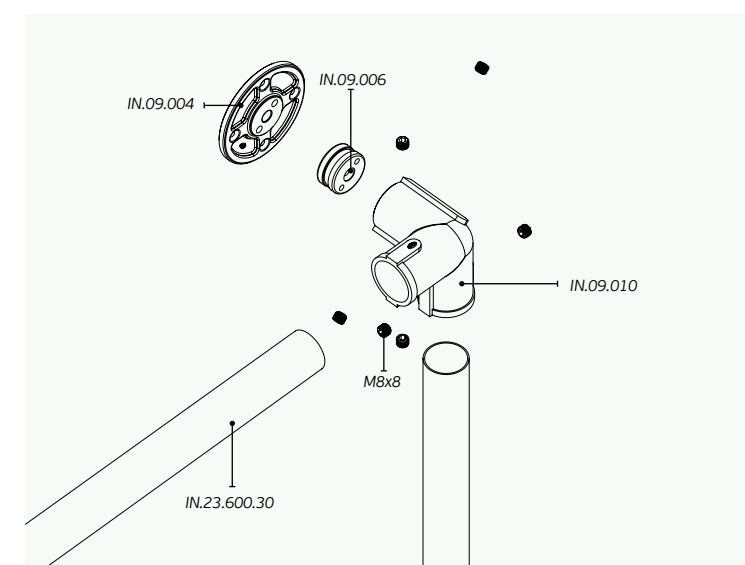

IN.09.004 + IN.09.011

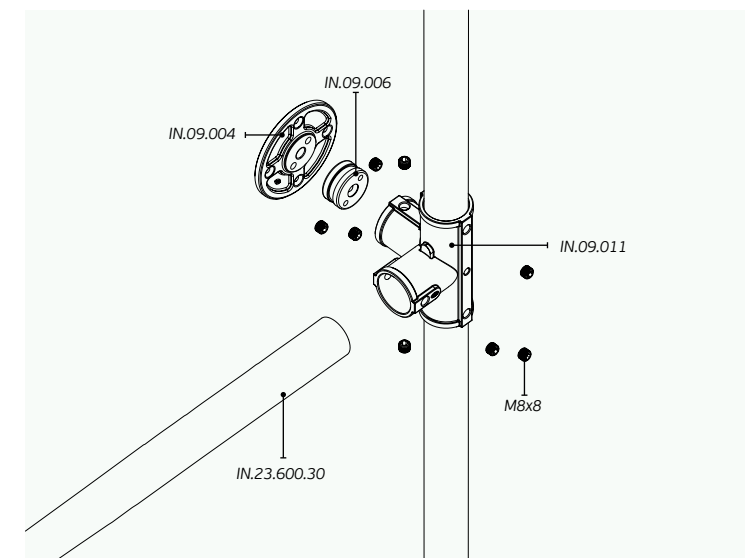

IN.09.004 + IN.09.012

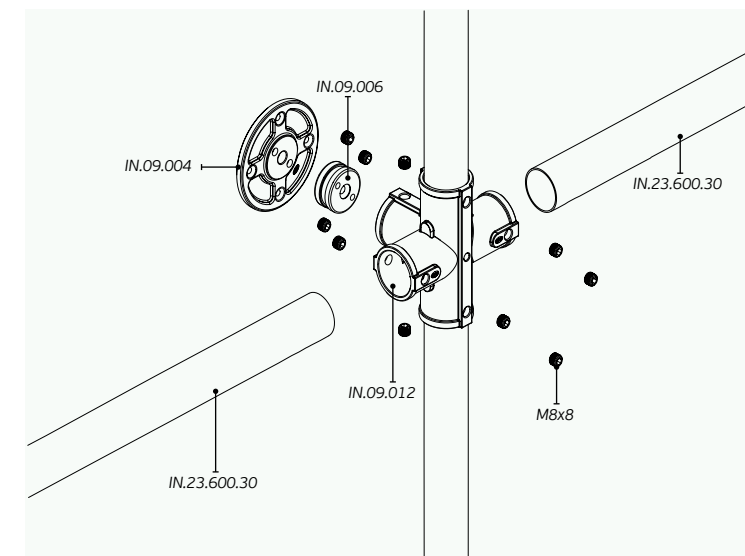

SISTEMAS MODULARES / MODULAR SYSTEMS / SISTEMAS MODULARES.



.P
Mirror finish

.TB
PVD Titanium black

.TG
PVD Titanium gold

.TCO
PVD Titanium copper

.TCH
PVD Titanium chocolate



IN.14.041.B
Cabide / Hook / Percha

IN.14.041.C
Cabide / Hook / Percha

IN.14.041.N
Cabide / Hook / Percha

IN.14.040.B
Cabide / Hook / Percha

IN.14.040.C
Cabide / Hook / Percha

IN.14.040.N
Cabide / Hook / Percha

.TB .TG .TCO .TCH

MATERIAL: EN 1.4301 / AISI 304 + PELE / LEATHER / PIEL

ACABAMENTO / FINISH: RAW

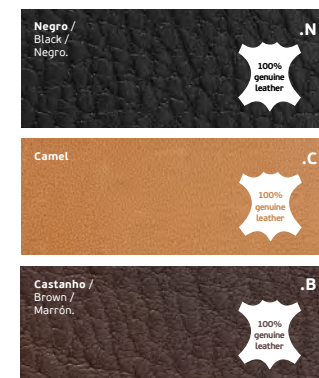
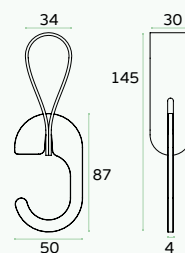

.TB .TG .TCO .TCH

MATERIAL: EN 1.4301 / AISI 304 + PELE / LEATHER / PIEL

ACABAMENTO / FINISH: RAW

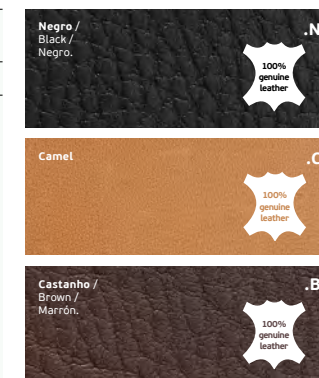
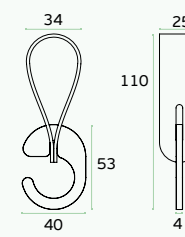

SISTEMAS MODULARES / MODULAR SYSTEMS / SISTEMAS MODULARES.

NEW

IN.09.030

Prateleira para sistema CONNECT /
Shelf for CONNECT system /
Prateleira para sistema CONNECT

ACABAMENTO / FINISH: RAL 9005

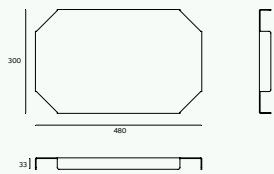

NEW

IN.23.600.30.205

Tube em aço inox para utilizar com
a prateleira do sistema connect
IN.09.030 (Ø30 - 205mm) /
Stainless steel tube to be used with
the shelf IN.09.030 of the connect
system (Ø30 - 205mm) / Tubo de acero
inoxidable para usar con el estante del
sistema connect IN.09.030
(Ø30 - 205mm)

.TB .TG .TCO

MATERIAL: EN 1.4301 / AISI 304

ACABAMENTO / FINISH / ACABADO:
STANDARD: SATINADO / SATIN / SATIN

OPTIONAL: PVD TITANIUM COATED

.TB / .TG / .TCO /



stainless steel



pvd titanium black



pvd titanium copper



pvd titanium gold

Ø30

NEW

IN.23.600.30.480

Tube em aço inox para utilizar com
a prateleira do sistema connect
IN.09.030 (Ø30 - 480mm) /
Stainless steel tube to be used with
the shelf IN.09.030 of the connect
system (Ø30 - 480mm) / Tubo de acero
inoxidable para usar con el estante del
sistema connect IN.09.030
(Ø30 - 480mm)

.TB .TG .TCO

MATERIAL: EN 1.4301 / AISI 304

ACABAMENTO / FINISH / ACABADO:
STANDARD: SATINADO / SATIN / SATIN

OPTIONAL: PVD TITANIUM COATED

.TB / .TG / .TCO /



stainless steel



pvd titanium black



pvd titanium copper



pvd titanium gold

Ø30

.P
Mirror
finish

.TB
PVD
Titanium
black

.TG
PVD
Titanium
gold

.TCO
PVD
Titanium
copper

.TCH
PVD
Titanium
chocolate



SISTEMAS MODULARES / MODULAR SYSTEMS / SISTEMAS MODULARES.



NEW



IN.00.392
Puxador de porta fixo / Fixed door knob / Pomo de puerta fijo

.TB .TG .TCO .TCH

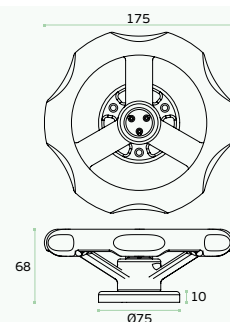

MATERIAL: EN 1.4301 / AISI 304
ACABAMENTO / FINISH / ACABADO: STANDARD: RAW
OPTIONAL: PVD TITANIUM COATED
.TB / .TG / .TCO / .TCH

NEW



IN.00.391
Puxador de porta fixo / Fixed door knob / Pomo de puerta fijo

.TB .TG .TCO .TCH



MATERIAL: EN 1.4301 / AISI 304
ACABAMENTO / FINISH / ACABADO: STANDARD: RAW
OPTIONAL: PVD TITANIUM COATED
.TB / .TG / .TCO / .TCH

SISTEMAS MODULARES / MODULAR SYSTEMS / SISTEMAS MODULARES.

NEW



IN.00.390
Puxador de porta com roseta / Door lever handle with rose / Manilla de puerta con roseta.

- .TB
- .TG
- .TCO
- .TCH

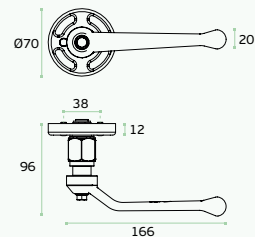

MATERIAL: EN 1.4301 / AISI 304
ACABAMENTO / FINISH / ACABADO: STANDARD: RAW
OPTIONAL: PVD TITANIUM COATED
.TB / .TG / .TCO / .TCH



IN.00.390.R
red lacquer



IN.00.390.TB
pvd titanium black



IN.00.390.TG
pvd titanium gold



IN.00.390.TCO
pvd titanium copper



IN.00.390.TCH
pvd titanium chocolate

.P
Mirror finish

.TB
PVD Titanium black

.TG
PVD Titanium gold

.TCO
PVD Titanium copper

.TCH
PVD Titanium chocolate

NEW

IN.07.390
Asa de porta / Door handle / Manillon de puerta.

- .TB
- .TG
- .TCO
- .TCH

MATERIAL: EN 1.4301 / AISI 304
ACABAMENTO / FINISH / ACABADO: STANDARD: RAW
OPTIONAL: PVD TITANIUM COATED
.TB / .TG / .TCO / .TCH

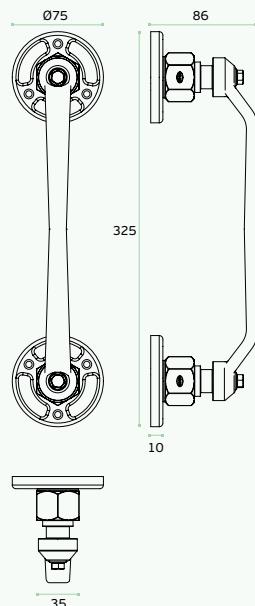

IN.07.390.TB
pvd titanium black



IN.07.390.TG
pvd titanium gold



IN.07.390.TB
pvd titanium black



IN.07.390.TG
pvd titanium gold



BATENTES /
DOOR STOPPERS / TOPES DE PUERTA.

IMAGE / IMAGEM:
IN.13.190.60

BATENTE DE PAVIMENTO
COM RETENTOR MAGNÉTICO /
DOOR STOPPER WITH
MAGNETIC RETAINER /
TOPE DE PUERTA CON
RETENEDOR MAGNÉTICO.

Sistema magnético com curso, para ajuste automático a diferentes distâncias da porta ao pavimento e simultaneamente, reduz a precisão na instalação. Ao aproximar a porta do batente, o magnético sobe e reduz a velocidade do fecho da porta até à sua imobilização.

Magnetic system with automatic height adjustment to different distances from the door to the floor and simultaneously, reduces installation accuracy. When approaching the door to the stopper, the magnetic rises and reduces the closing speed of the door until it stops.

Sistema magnético com ajuste automático de la altura a diferentes distancias de la puerta al suelo y al mismo tiempo reduce la precisión en la instalación. Al acercarse la puerta del tope, lo magnético empieza a subir y ralentiza la velocidad de cierre de la puerta hasta sólo retención.

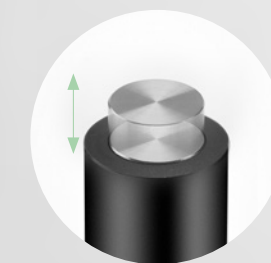
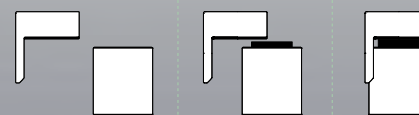

MAGNETIC

IMAGE / IMAGEM:
IN.13.186

NEW



IN.13.192
Retentor de porta magnético duplo /
Double magnetic door holder /
Retenedor de puerta magnético doble.

MATERIAL: EN 1.4301 / AISI 304

ACABAMENTO / FINISH / ACABADO: SATINADO / SATIN

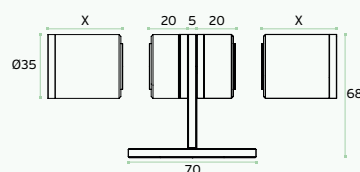

REF.	X
IN.13.192.40	20
IN.13.192.60	40
IN.13.192.80	60

MAGNETIC

NEW



IN.13.191
Retentor de porta magnético /
Magnetic door holder /
Retenedor de puerta magnético.

MATERIAL: EN 1.4301 / AISI 304

ACABAMENTO / FINISH / ACABADO: SATINADO / SATIN

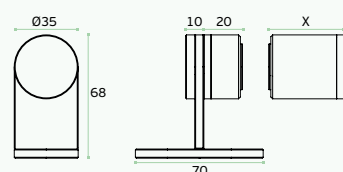

REF.	X
IN.13.191.40	20
IN.13.191.60	40
IN.13.191.80	60

MAGNETIC

NEW



IN.13.190
Retentor de porta magnético /
Magnetic door holder /
Retenedor de puerta magnético.

MATERIAL: EN 1.4301 / AISI 304

ACABAMENTO / FINISH / ACABADO: SATINADO / SATIN

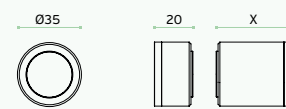

REF.	X
IN.13.190.40	20
IN.13.190.60	40
IN.13.190.80	60

MAGNETIC



Espeçura
Thickness



Magnético
Magnetic



Peso
Weight



Adesivo
Adhesive



Espeçura
Thickness



Magnético
Magnetic



Peso
Weight



Adesivo
Adhesive



IN.13.186
Retentor de porta magnético /
Magnetic door holder /
Retenedor de puerta magnético.
Design: Christian Magalhães

MATERIAL: EN 1.4301 / AISI 304

ACABAMENTO / FINISH / ACABADO: SATINADO / SATIN

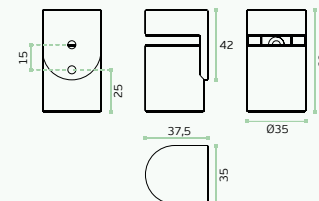

MAGNETIC



8-12
mm

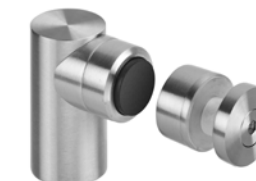

IN.13.187
Batente de porta com retenção magnética para
porta em vidro /
Door stopper with magnetic holder
for glass door /
Tope de puerta con retenedor magnético
para puerta en cristal.

MATERIAL: EN 1.4301 / AISI 304

ACABAMENTO / FINISH / ACABADO: SATINADO / SATIN

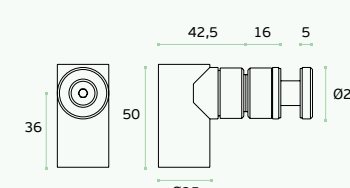

MAGNETIC



IN.13.189
Batente de porta com retenção magnética /
Door stopper with magnetic holder /
Tope de puerta magnético.

MATERIAL: EN 1.4301 / AISI 304

ACABAMENTO / FINISH / ACABADO: SATINADO / SATIN

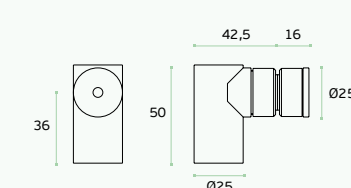

MAGNETIC

BATENTES / DOOR STOPPERS / TOPES DE PUERTA.

BATENTE / RETENTOR AÉREO DE PORTA OCULTO / CONCEALED OVERHEAD DOOR STOP / HOLDER / TOPE / RETENEDOR AÉREO DE PUERTA OCULTO.

- Aplicável em portas de batente ou vai-vem
- Reversível;
- Função de batente ou retentor escolhida na instalação;
- Carril deslizante estreito com terminais;
- Recomendado para uso intensivo 110° de abertura máxima (batente ou retentor ajustável dos 45° a 110°)
- Espessura mínima de porta 30 mm

- For single or double action doors;
- Non-handed;
- Stop or hold open depending on installation;
- Concealed slim sliding track with end caps;
- Recommended for HEAVY DUTY;
- 110° maximum opening (stop or hold open adjustable from 45° to 110°);
- Minimum door thickness 30mm.

- Aplicable en puertas batiente o de doble acción;
- Reversible;
- Función de freno o retención elegida en la instalación;
- Carril deslizante estrecho con terminales.
- Recomendado para uso intensivo 110° de apertura máxima (parada o retención ajustable de 45° a 110°)
- Grosor mínimo de la puerta 30mm.

 IMAGE / IMAGEM:
 IN.23.150.G

 IMAGE / IMAGEM:
 IN.13.010

NEW



IN.23.150.G (SILVER)

Batente / retentor aéreo de porta oculto
 Desenvolvido para proteger porta, parede e ferragens do uso abusivo especialmente em espaços comerciais ou institucionais. Este sistema substitui o tradicional batente de porta de pavimento. Disponível em Preto RAL 9005 ou cinzento RAL 9006

Concealed overhead door stop / holder
 Overhead holders/stops are designed to protect the door, Wall and hardware from the abuse commonly found in commercial and institutional applications. This system replaces the floor door stopper. Available in negro RAL 9005 (Black) and RAL 9006 (SILVER)

Tope /retenedor aéreo de puerta oculto
 Desarrollado para proteger las puertas, pared y los herrajes del uso abusivo, especialmente en espacios comerciales o institucionales. Este sistema sustituye a lo tradicional tope de puerta del suelo. Disponible en negro RAL 9005 o gris RAL 9006

ACABAMENTO / FINISH / ACABADO: RAL 9006 (SILVER)

IN.23.150.G



ACABAMENTO / FINISH / ACABADO: RAL 9005 (BLACK)

IN.23.150.B

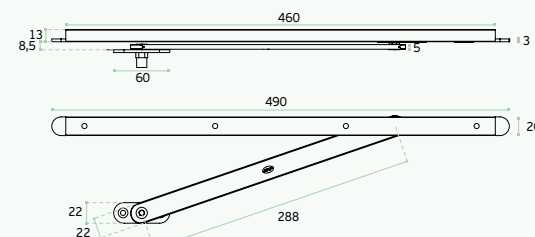

HEAVY DUTY

IN.13.010

Batente de chão para portas pesadas com amortecedor e retentor /
 Door stopper for heavy doors with shock absorber and retainer /
 Tope de puerta para puertas pesadas con amortiguador y retenedor.

MATERIAL: EN 1.4301 / AISI 304

ACABAMENTO / FINISH / ACABADO: SATINADO / SATIN / SATIN

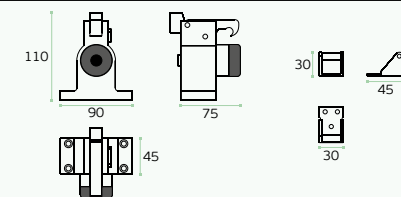

IN.13.010.T
 Retentor de substituição /
 Replacement stopper /
 Retentor de sustitución.



HEAVY DUTY

IN.13.011

Batente de chão para portas pesadas com amortecedor /
 Door stopper for heavy doors with shock absorber /
 Tope de puerta para puertas pesadas con amortiguador.

MATERIAL: EN 1.4301 / AISI 304

ACABAMENTO / FINISH / ACABADO: SATINADO / SATIN / SATIN

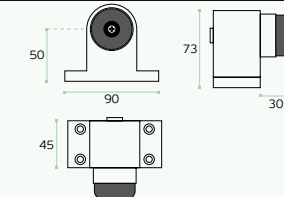

BATENTES / DOOR STOPPERS / TOPES DE PUERTA.



IN.13.008
Batente de chão /
Door stopper / Tope de puerta.
Design: Miguel Vasconcelos



MATERIAL: EN 1.4301 / AISI 304

ACABAMENTO / FINISH / ACABADO: SATINADO / SATIN

OPCIONAL / OPTIONAL: POLIDO / POLISHED / PULIDO

OPCIONAL / OPTIONAL: PVD TITANIUM

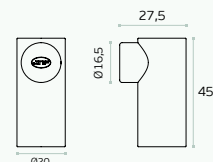

IN.13.355 DUO
Batente de chão /
Door stopper / Tope de puerta



MATERIAL: EN 1.4301 / AISI 304

ACABAMENTO / FINISH / ACABADO: SATINADO / SATIN

OPCIONAL / OPTIONAL: POLIDO / POLISHED / PULIDO

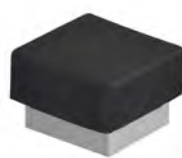
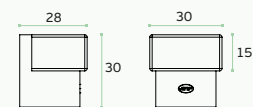

IN.13.356
Batente de chão /
Door stopper / Tope de puerta



MATERIAL: EN 1.4301 / AISI 304

ACABAMENTO / FINISH / ACABADO: SATINADO / SATIN

OPCIONAL / OPTIONAL: POLIDO / POLISHED / PULIDO

OPCIONAL / OPTIONAL: PVD TITANIUM

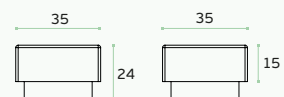

.P
Mirror
finish

.TB
PVD
Titanium
black

.TG
PVD
Titanium
gold

.TCO
PVD
Titanium
copper

.TCH
PVD
Titanium
chocolate

.P
Mirror
finish

.TB
PVD
Titanium
black

.TG
PVD
Titanium
gold

.TCO
PVD
Titanium
copper

.TCH
PVD
Titanium
chocolate



IN.13.185.30 LOFT
Batente de chão /
Door stopper / Tope de puerta.
Design: Christian Magalhães



MATERIAL: EN 1.4301 / AISI 304

ACABAMENTO / FINISH / ACABADO: SATINADO / SATIN

OPCIONAL / OPTIONAL: POLIDO / POLISHED / PULIDO

OPCIONAL / OPTIONAL: PVD TITANIUM

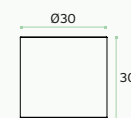

IN.13.185.50 LOFT
Batente de chão /
Door stopper / Tope de puerta.
Design: Christian Magalhães



MATERIAL: EN 1.4301 / AISI 304

ACABAMENTO / FINISH / ACABADO: SATINADO / SATIN

OPCIONAL / OPTIONAL: POLIDO / POLISHED / PULIDO

OPCIONAL / OPTIONAL: PVD TITANIUM

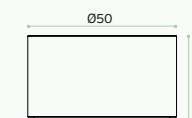

RR.13.005 SIMPULLPUSH
Batente de chão /
Door stopper / Tope de puerta.
Design: Rita Rodrigues

MATERIAL: EN 1.4301 / AISI 304

ACABAMENTO / FINISH / ACABADO: SATINADO / SATIN / SATIN

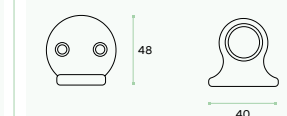

IN.23.009
Retenedor de porta /
Door holder / Retenedor de puerta.
Design: Miguel Vasconcelos

MATERIAL: EN 1.4301 / AISI 304

ACABAMENTO / FINISH / ACABADO: SATINADO / SATIN / SATIN

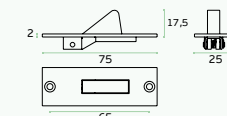

NEW



IN.13.357
Batente de chão /
Door stopper /
Tope de puerta.

MATERIAL: EN 1.4301 / AISI 304

ACABAMENTO / FINISH / ACABADO: SATINADO / SATIN

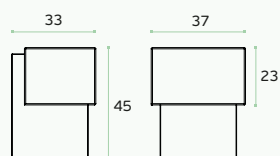

NEW



IN.13.358
Batente de chão /
Door stopper /
Tope de puerta.

MATERIAL: EN 1.4301 / AISI 304

ACABAMENTO / FINISH / ACABADO: SATINADO / SATIN

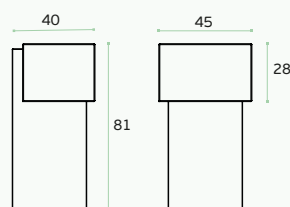

IN.13.356.TB
Titanium black

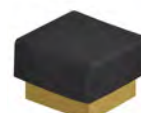

IN.13.356.TG
Titanium gold



IN.13.356.TCO
Titanium copper

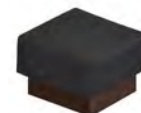

IN.13.356.TCH
Titanium chocolate



Espessura
Thickness



Magnético
Magnetic



KG
Peso
Weight



3M
Adesivo
Adhesive



SR.13.006.B SKIN
Batente de chão /
Door stopper / Tope de puerta.
Design: Susana Ribeiro

MATERIAL: EN 1.4301 / AISI 304 + NATURAL LEATHER

ACABAMENTO / FINISH / ACABADO: SATINADO / SATIN



SR.13.006.C SKIN
Batente de chão /
Door stopper / Tope de puerta.
Design: Susana Ribeiro



SR.13.006.N SKIN
Batente de chão /
Door stopper / Tope de puerta.
Design: Susana Ribeiro

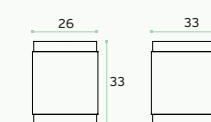

IN.13.BS.25
IN.13.BS.30
IN.13.BS.35
Base para batente de porta com
adesivo extra forte / Door stopper
base with special sticker /
Base para tope de puerta con
pegamiento extra fuerte.



BATENTES / DOOR STOPPERS / TOPES DE PUERTA.



IN.13.112.10
IN.13.112.20
Batente de porta para colar no vidro / Door stopper for glass fixing / Tope de puerta para fijar en cristal.



MATERIAL: EN 1.4301 / AISI 304

ACABAMENTO / FINISH / ACABADO:
SATINADO / SATIN / SATIN

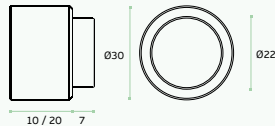

IN.13.111.20
Batente de porta para fixar na parede / Door stopper for wall fixing / Tope de puerta para fijar en la pared.



MATERIAL: EN 1.4301 / AISI 304

ACABAMENTO / FINISH / ACABADO:
SATINADO / SATIN / SATIN

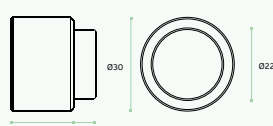

IN.13.111.30
IN.13.111.35
Batente de porta para fixar na parede / Door stopper for wall fixing / Tope de puerta para fijar en la pared.



MATERIAL: EN 1.4301 / AISI 304

ACABAMENTO / FINISH / ACABADO:
SATINADO / SATIN / SATIN

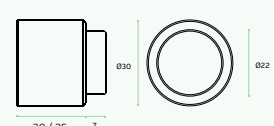

IN.13.111.50
Batente de porta para fixar na parede / Door stopper for wall fixing / Tope de puerta para fijar en la pared.



MATERIAL: EN 1.4301 / AISI 304

ACABAMENTO / FINISH / ACABADO:
SATINADO / SATIN / SATIN

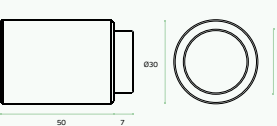

.P
Mirror finish

.TB
PVD
Titanium black

.TG
PVD
Titanium gold

.TCO
PVD
Titanium copper

.TCH
PVD
Titanium chocolate



IN.13.123.SB.30
Batente de porta para fixar na parede / Door stopper for wall fixing / Tope de puerta para fijar en la pared.



MATERIAL: EN 1.4301 / AISI 304

ACABAMENTO / FINISH / ACABADO:
SATINADO / SATIN + POLIDO / POLISHED

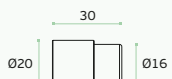

IN.13.123.SB.40
Batente de porta para fixar na parede / Door stopper for wall fixing / Tope de puerta para fijar en la pared.



MATERIAL: EN 1.4301 / AISI 304

ACABAMENTO / FINISH / ACABADO:
SATINADO / SATIN + POLIDO / POLISHED

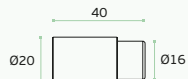

IN.13.123.SB.50
Batente de porta para fixar na parede / Door stopper for wall fixing / Tope de puerta para fijar en la pared.



MATERIAL: EN 1.4301 / AISI 304

ACABAMENTO / FINISH / ACABADO:
SATINADO / SATIN + POLIDO / POLISHED

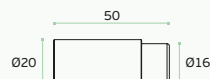

IN.13.123.SB.80
Batente de porta para fixar na parede / Door stopper for wall fixing / Tope de puerta para fijar en la pared.



MATERIAL: EN 1.4301 / AISI 304

ACABAMENTO / FINISH / ACABADO:
SATINADO / SATIN + POLIDO / POLISHED

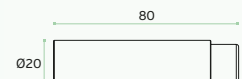

NEW



IN.13.002
Batente de chão / Door stopper / Tope de puerta.

MATERIAL: EN 1.4301 / AISI 304

ACABAMENTO / FINISH / ACABADO:
SATINADO / SATIN / SATIN

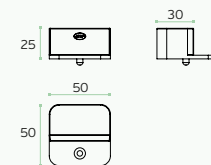

NEW



IN.13.003
Batente de chão / Door stopper / Tope de puerta.

MATERIAL: EN 1.4301 / AISI 304

ACABAMENTO / FINISH / ACABADO:
SATINADO / SATIN / SATIN

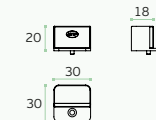

IN.13.005
Batente de chão / Door stopper / Tope de puerta.
Design: Miguel Vasconcelos

MATERIAL: EN 1.4301 / AISI 304

ACABAMENTO / FINISH / ACABADO:
SATINADO / SATIN / SATIN

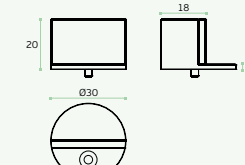

IN.13.004
Batente de chão / Door stopper / Tope de puerta.
Design: Miguel Vasconcelos

MATERIAL: EN 1.4301 / AISI 304

ACABAMENTO / FINISH / ACABADO:
SATINADO / SATIN / SATIN

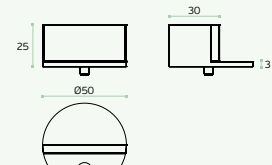

CABIDES / HOOKS / PERCHAS



IN.14.204 SLIM BLACK
Cabide /
Hook / Percha.
Design: Christian Magalhães

MATERIAL: ALUMINIO / ALUMINIUM

ACABAMENTO / FINISH / ACABADO:
RAL 9005

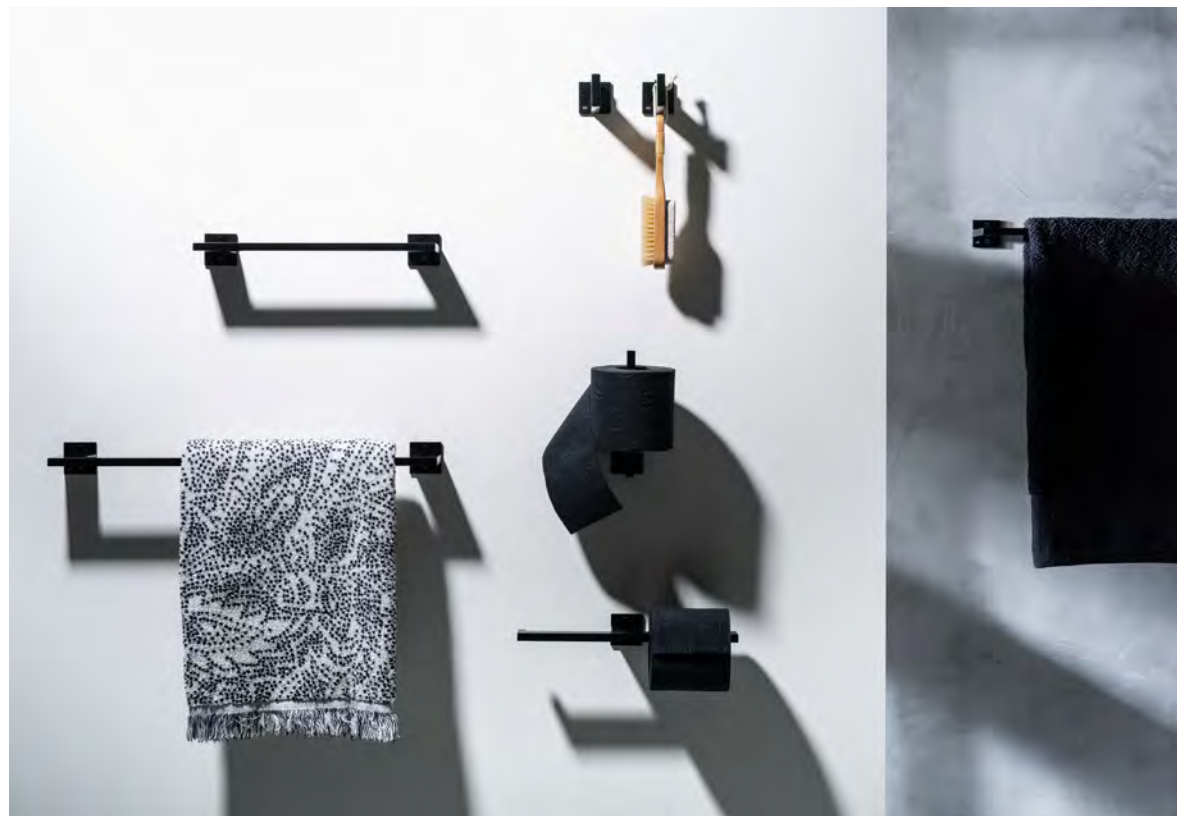
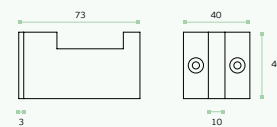

.P
Mirror
finish

.TB
PVD
Titanium
black

.TG
PVD
Titanium
gold

.TCO
PVD
Titanium
copper

.TCH
PVD
Titanium
chocolate



IN.14.123 NATUR WC
Cabide /
Hook / Percha.



MATERIAL: EN 1.4301 / AISI 304

ACABAMENTO / FINISH / ACABADO:
SATINADO / SATIN / SATIN

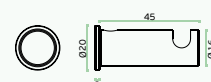

IN.14.124 NATUR WC
Cabide duplo /
Double hook / Percha doble.



MATERIAL: EN 1.4301 / AISI 304

ACABAMENTO / FINISH / ACABADO:
SATINADO / SATIN / SATIN

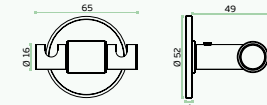

IN.14.300.14 BRANCH
Cabide / Hook / Percha.
Design: Christian Magalhães



MATERIAL: EN 1.4301 / AISI 304

ACABAMENTO / FINISH / ACABADO:
SATINADO / SATIN / SATIN

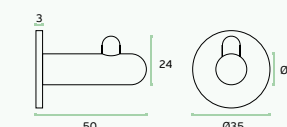

IN.14.300.19 BRANCH
Cabide / Hook / Percha.
Design: Christian Magalhães



MATERIAL: EN 1.4301 / AISI 304

ACABAMENTO / FINISH / ACABADO:
SATINADO / SATIN / SATIN

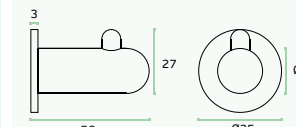

IN.14.204.W SLIM WHITE
Cabide /
Hook / Percha.
Design: Christian Magalhães

MATERIAL: ALUMINIO / ALUMINIUM

ACABAMENTO / FINISH / ACABADO:
RAL 9016

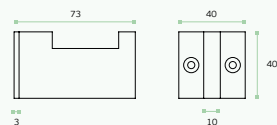

IN.14.418 WENGÉ
Cabide / Hook / Percha.
Design: Pedro Queirós

MATERIAL: EN 1.4301 / AISI 304 +
MADEIRA / WOOD / MADERA

ACABAMENTO / FINISH / ACABADO:
SATINADO / SATIN / SATIN

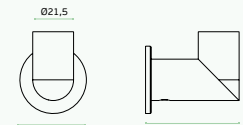

MR.14.006 MERIDIAN
Cabide / Hook / Percha.
Design: EVOL

MATERIAL: EN 1.4301 / AISI 304

ACABAMENTO / FINISH / ACABADO:
SATINADO / SATIN / SATIN

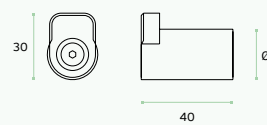

RV.14.002 SUBTIL
Cabide / Hook / Percha.
Design: Rui Viana

MATERIAL: EN 1.4301 / AISI 304

ACABAMENTO / FINISH / ACABADO:
SATINADO / SATIN / SATIN

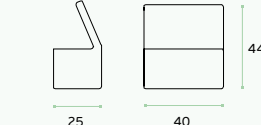

RV.14.002.P SUBTIL
Cabide / Hook / Percha.
Design: Rui Viana

MATERIAL: EN 1.4301 / AISI 304

ACABAMENTO / FINISH / ACABADO:
POLIDO / SATIN / SATIN

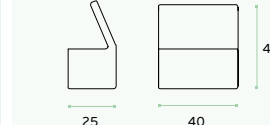

CABIDES / HOOKS / PERCHAS



IN.14.520
Cabide /
Hook / Percha.

.P

MATERIAL: EN 1.4301 / AISI 304

ACABAMENTO / FINISH / ACABADO:
SATINADO / SATIN / SATIN

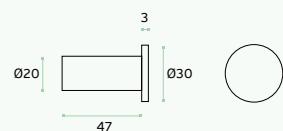

IN.14.525
Cabide /
Hook / Percha.

MATERIAL: EN 1.4301 / AISI 304

ACABAMENTO / FINISH / ACABADO:
SATINADO / SATIN / SATIN

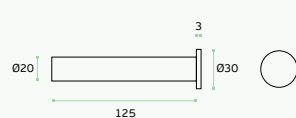

IN.14.400
Cabide / Hook / Percha.
Design: Christian Magalhães

MATERIAL: EN 1.4301 / AISI 304 +
ALUMINIO / ALUMINIUM

ACABAMENTO / FINISH / ACABADO:
SATINADO / SATIN / SATIN

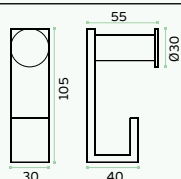

IN.14.502
Cabide / Hook / Percha.
Design: Christian Magalhães

MATERIAL: EN 1.4301 / AISI 304 +
ALUMINIO / ALUMINIUM

ACABAMENTO / FINISH / ACABADO:
SATINADO / SATIN / SATIN

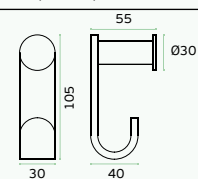

CS.14.004 MIMETIC
Cabide / Hook / Percha.
Design: Cátia Sul

MATERIAL: EN 1.4301 / AISI 304

ACABAMENTO / FINISH / ACABADO:
SATINADO / SATIN / SATIN

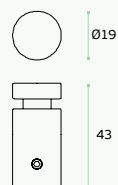

CS.14.004.Q MIMETIC
Cabide / Hook / Percha.
Design: Cátia Sul

MATERIAL: EN 1.4301 / AISI 304

ACABAMENTO / FINISH / ACABADO:
SATINADO / SATIN / SATIN

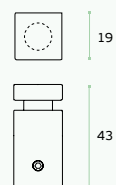

IN.14.177 QUADRO
Cabide /
Hook / Percha.

MATERIAL: EN 1.4301 / AISI 304

ACABAMENTO / FINISH / ACABADO:
SATINADO / SATIN / SATIN

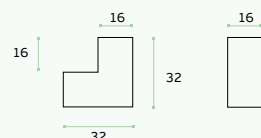

AM.14.011 TOUCH IT
Cabide / Hook / Percha.
Design: Ana Moreira

MATERIAL: EN 1.4301 / AISI 304

ACABAMENTO / FINISH / ACABADO:
SATINADO / SATIN / SATIN

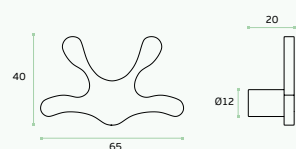

CABIDES / HOOKS / PERCHAS



IN.14.500
Cabide / Hook / Percha.
IN.14.500.G
Cabide com adesivo /
Hook with glue / Percha con pegamiento.

MATERIAL: EN 1.4301 / AISI 304

ACABAMENTO / FINISH / ACABADO:
SATINADO / SATIN / SATIN

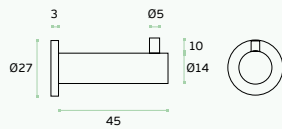

IN.14.505
Cabide /
Hook / Percha.

MATERIAL: EN 1.4301 / AISI 304

ACABAMENTO / FINISH / ACABADO:
SATINADO / SATIN / SATIN

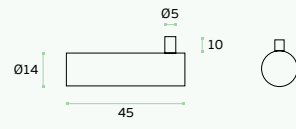

IN.14.506
IN.14.506.P
Cabide /
Hook / Percha.

MATERIAL: EN 1.4301 / AISI 304

ACABAMENTO / FINISH / ACABADO:
SATINADO + POLIDO / SATIN + POLISHED
/ SATIN + PULIDO

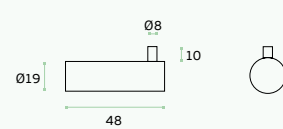

IN.14.515
Cabide /
Hook / Percha.

MATERIAL: EN 1.4301 / AISI 304

ACABAMENTO / FINISH / ACABADO:
SATINADO / SATIN / SATIN

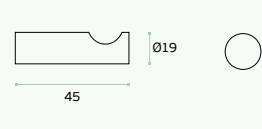

.P
Mirror
finish

.TB
PVD
Titanium
black

.TG
PVD
Titanium
gold

.TCO
PVD
Titanium
copper

.TCH
PVD
Titanium
chocolate

.P
Mirror
finish

.TB
PVD
Titanium
black

.TG
PVD
Titanium
gold

.TCO
PVD
Titanium
copper

.TCH
PVD
Titanium
chocolate



IN.14.528
Cabide /
Hook / Percha.

MATERIAL: EN 1.4301 / AISI 304

ACABAMENTO / FINISH / ACABADO:
SATINADO / SATIN / SATIN

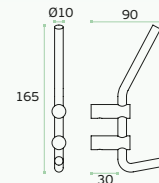

IN.14.544
Cabide /
Hook / Percha.

MATERIAL: EN 1.4301 / AISI 304

ACABAMENTO / FINISH / ACABADO:
SATINADO / SATIN / SATIN

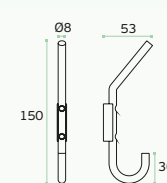

IN.14.545
Cabide /
Hook / Percha.

MATERIAL: EN 1.4301 / AISI 304

ACABAMENTO / FINISH / ACABADO:
SATINADO / SATIN / SATIN

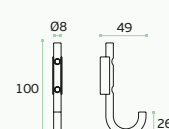

IN.14.501
Cabide / Hook / Percha.
IN.14.501.G
Cabide com adesivo /
Hook with glue / Percha con pegamiento.

MATERIAL: EN 1.4301 / AISI 304

ACABAMENTO / FINISH / ACABADO:
SATINADO / SATIN / SATIN

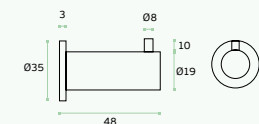

IN.14.501.V
Cabide para vidro /
Hook for glass /
Percha para cristal.

MATERIAL: EN 1.4301 / AISI 304

ACABAMENTO / FINISH / ACABADO:
SATINADO / SATIN / SATIN

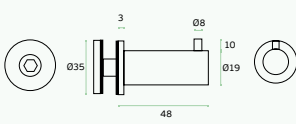

IN.14.510
Cabide / Hook / Percha.
IN.14.510.G
Cabide com adesivo /
Hook with glue / Percha con pegamiento.

MATERIAL: EN 1.4301 / AISI 304

ACABAMENTO / FINISH / ACABADO:
SATINADO / SATIN / SATIN

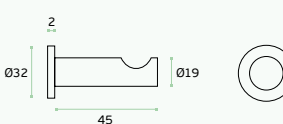

IN.14.510.V
Cabide para vidro /
Hook for glass /
Percha para cristal.

MATERIAL: EN 1.4301 / AISI 304

ACABAMENTO / FINISH / ACABADO:
SATINADO / SATIN / SATIN

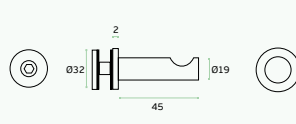

Espessura
Thickness

Magnético
Magnetic

Peso
Weight

Adesivo
Adhesive

Espessura
Thickness

Magnético
Magnetic

Peso
Weight

Adesivo
Adhesive



IN.14.542
Cabide /
Hook / Percha.

MATERIAL: EN 1.4301 / AISI 304

ACABAMENTO / FINISH / ACABADO:
SATINADO / SATIN / SATIN

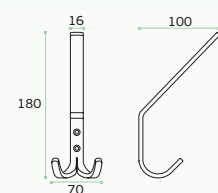

IN.14.543
Cabide /
Hook / Percha.

MATERIAL: EN 1.4301 / AISI 304

ACABAMENTO / FINISH / ACABADO:
SATINADO / SATIN / SATIN

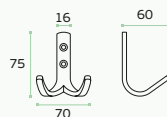

IN.14.540
Cabide /
Hook / Percha.

MATERIAL: EN 1.4301 / AISI 304

ACABAMENTO / FINISH / ACABADO:
SATINADO / SATIN / SATIN

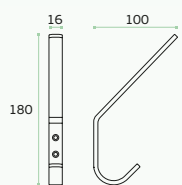

IN.14.541
Cabide /
Hook / Percha.

MATERIAL: EN 1.4301 / AISI 304

ACABAMENTO / FINISH / ACABADO:
SATINADO / SATIN / SATIN

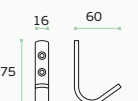

CABIDES / HOOKS / PERCHAS



.P
Mirror finish

.TB
PVD Titanium black

.TG
PVD Titanium gold

.TCO
PVD Titanium copper

.TCH
PVD Titanium chocolate



IN.14.020
Cabide / Hook / Percha.



MATERIAL: EN 1.4372 / AISI 201

ACABAMENTO / FINISH / ACABADO: SATIN

OPTIONAL: PVD TITANIUM COATED

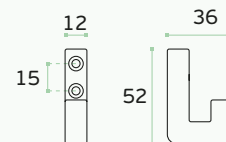

IN.14.526
Cabide duplo / Double hook / Percha doble.

MATERIAL: EN 1.4301 / AISI 304

ACABAMENTO / FINISH / ACABADO: SATINADO / SATIN

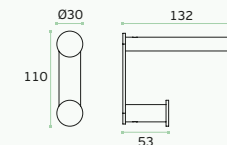

IN.14.527
Cabide duplo / Double hook / Percha doble.

MATERIAL: EN 1.4301 / AISI 304

ACABAMENTO / FINISH / ACABADO: SATINADO / SATIN

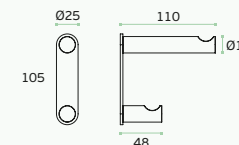

IN.14.601.S
Cabide / Hook / Percha.

MATERIAL: ALUMINIO / ALUMINIUM

ACABAMENTO / FINISH / ACABADO: SATINADO / SATIN

DESIGN: CHRISTIAN MAGALHÃES

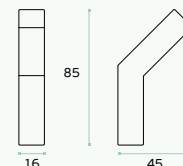

IN.14.601.B
Cabide / Hook / Percha.

MATERIAL: ALUMINIO / ALUMINIUM

ACABAMENTO / FINISH / ACABADO: RAL 9005

DESIGN: CHRISTIAN MAGALHÃES

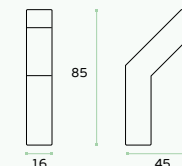

IN.14.601.P
Cabide / Hook / Percha.

MATERIAL: ALUMINIO / ALUMINIUM

ACABAMENTO / FINISH / ACABADO: POLIDO / POLISHED

DESIGN: CHRISTIAN MAGALHÃES

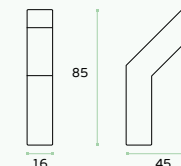

CABIDES / HOOKS / PERCHAS

IN.14.126 STOUT WC Cabide / Hook / Percha.



.TB .TG .TCO .TCH



MATERIAL: EN 1.4301 / AISI 304

ACABAMENTO / FINISH / ACABADO:
STANDARD: SATINADO / SATIN / SATIN

OPTIONAL: PVD TITANIUM COATED

.TB / .TG / .TCO / .TCH

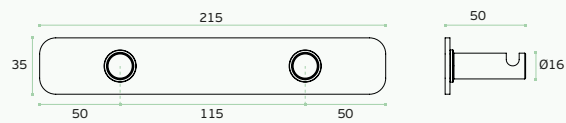

IN.14.125 STOUT WC Cabide triplo / Triple hook / Percha triple.



.TB .TG .TCO .TCH



MATERIAL: EN 1.4301 / AISI 304

ACABAMENTO / FINISH / ACABADO:
STANDARD: SATINADO / SATIN / SATIN

OPTIONAL: PVD TITANIUM COATED

.TB / .TG / .TCO / .TCH

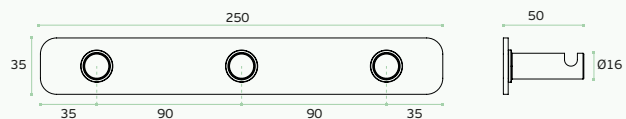

IN.14.520.3 Cabide triplo / Triple hook / Percha triple.

IN.14.520.3.G Cabide triplo com adesivo / Triple hook with glue / Percha triple con pegamiento.

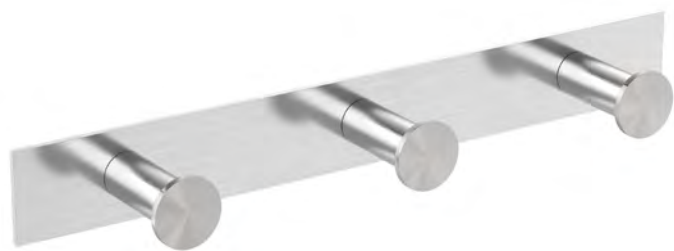

MATERIAL: EN 1.4301 / AISI 304

ACABAMENTO / FINISH / ACABADO:
STANDARD: SATINADO / SATIN / SATIN

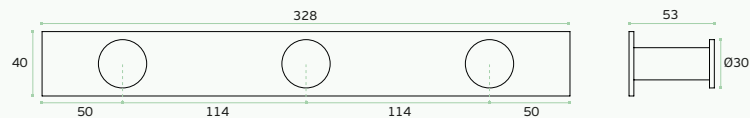

IN.14.300.3.14 BRANCH Cabide triplo / Triple hook / Percha triple. Design: Christian Magalhães



.TB .TG .TCO .TCH



MATERIAL: EN 1.4301 / AISI 304

ACABAMENTO / FINISH / ACABADO:
STANDARD: SATINADO / SATIN / SATIN

OPTIONAL: PVD TITANIUM COATED

.TB / .TG / .TCO / .TCH

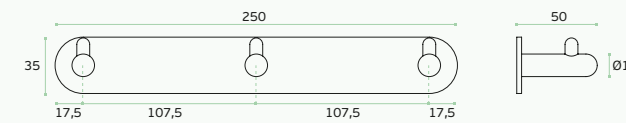

IN.14.300.3.19 BRANCH Cabide triplo / Triple hook / Percha triple. Design: Christian Magalhães



.TB .TG .TCO .TCH



MATERIAL: EN 1.4301 / AISI 304

ACABAMENTO / FINISH / ACABADO:
STANDARD: SATINADO / SATIN / SATIN

OPTIONAL: PVD TITANIUM COATED

.TB / .TG / .TCO / .TCH

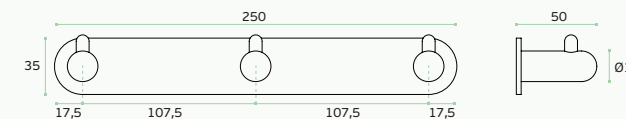

.P
Mirror
finish

.P
Mirror
finish

.TB
PVD
Titanium
black

.TB
PVD
Titanium
black

.TG
PVD
Titanium
gold

.TG
PVD
Titanium
gold

.TCO
PVD
Titanium
copper

.TCO
PVD
Titanium
copper

.TCH
PVD
Titanium
chocolate

.TCH
PVD
Titanium
chocolate

Espeçura
Thickness

Espeçura
Thickness

Magnético
Magnetic

Magnético
Magnetic

KG
Peso
Weight

KG
Peso
Weight

3M
Adesivo
Adhesive

3M
Adesivo
Adhesive

IN.14.177.3 Cabide triplo / Triple hook / Percha triple.

IN.14.177.3.G Cabide triplo com adesivo / Triple hook with glue / Percha triple con pegamiento.

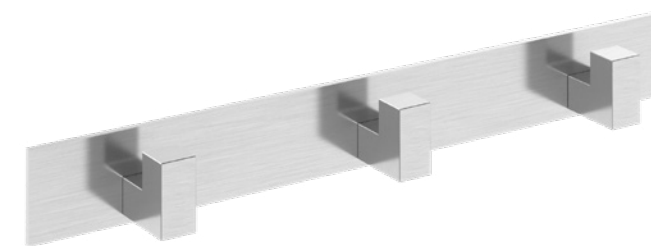

MATERIAL: EN 1.4301 / AISI 304

ACABAMENTO / FINISH / ACABADO:
STANDARD: SATINADO / SATIN / SATIN

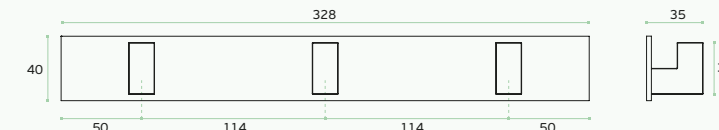

CABIDES / HOOKS / PERCHAS

IN.14.505.3
Cabide triplo /
Triple hook / Percha triple.

IN.14.505.3.G
Cabide triplo com adesivo /
Triple hook with glue /
Percha triple con pegamiento.



MATERIAL: EN 1.4301 / AISI 304

ACABAMENTO / FINISH / ACABADO:
STANDARD: SATINADO / SATIN / SATIN

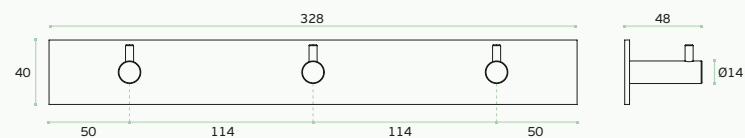

IN.14.506.3
Cabide triplo /
Triple hook / Percha triple.

IN.14.506.3.G
Cabide triplo com adesivo /
Triple hook with glue /
Percha triple con pegamiento.



MATERIAL: EN 1.4301 / AISI 304

ACABAMENTO / FINISH / ACABADO:
STANDARD: SATINADO / SATIN / SATIN

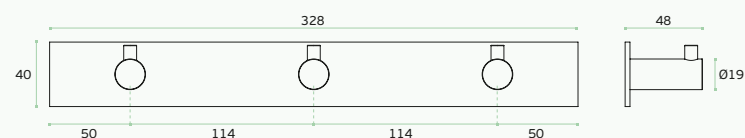

IN.14.600
Cabide quadruplo /
Quadruple hook / Percha quadruplo.

IN.14.600.G
Cabide quadruplo com adesivo /
Quadruple hook with glue /
Percha quadruplo con pegamiento.



MATERIAL: EN 1.4301 / AISI 304

ACABAMENTO / FINISH / ACABADO:
STANDARD: SATINADO / SATIN / SATIN

OPTIONAL: PVD TITANIUM COATED

.TB / .TG / .TCO / .TCH

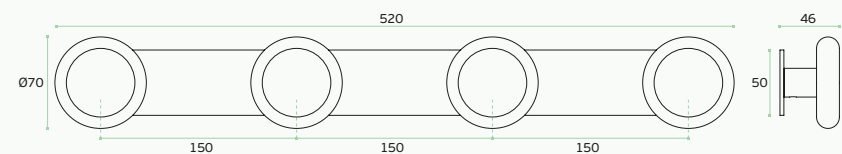

.P
Mirror
finish

.TB
PVD
Titanium
black

.TG
PVD
Titanium
gold

.TCO
PVD
Titanium
copper

.TCH
PVD
Titanium
chocolate

.P
Mirror
finish

.TB
PVD
Titanium
black

.TG
PVD
Titanium
gold

.TCO
PVD
Titanium
copper

.TCH
PVD
Titanium
chocolate

IN.14.535
Cabide triplo /
Triple hook / Percha triple.

MATERIAL: EN 1.4301 / AISI 304

ACABAMENTO / FINISH / ACABADO:
STANDARD: SATINADO / SATIN / SATIN

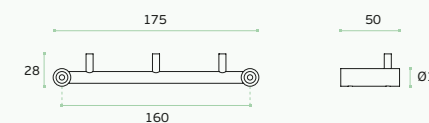

AM.14.012
Cabide triplo /
Triple hook / Percha triple.

AM.14.012.G
Cabide triplo com adesivo /
Triple hook with glue /
Percha triple con pegamiento.



MATERIAL: EN 1.4301 / AISI 304

ACABAMENTO / FINISH / ACABADO:
STANDARD: SATINADO / SATIN / SATIN

DESIGN: ANA MOREIRA

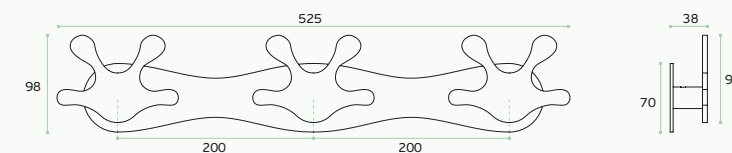
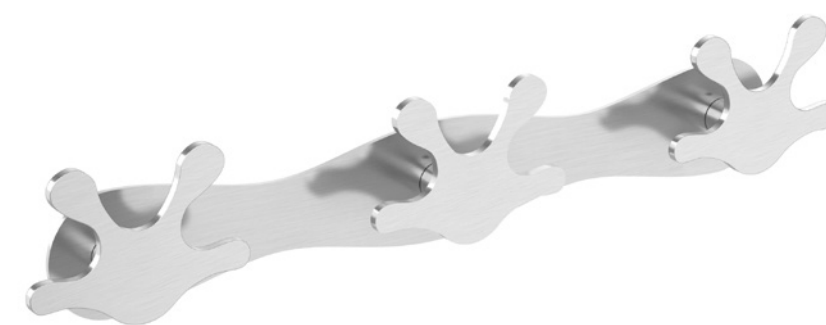

Espessura
Thickness



Magnético
Magnetic



KG
Peso
Weight



3M
Adesivo
Adhesive



Espessura
Thickness



Magnético
Magnetic



KG
Peso
Weight



3M
Adesivo
Adhesive

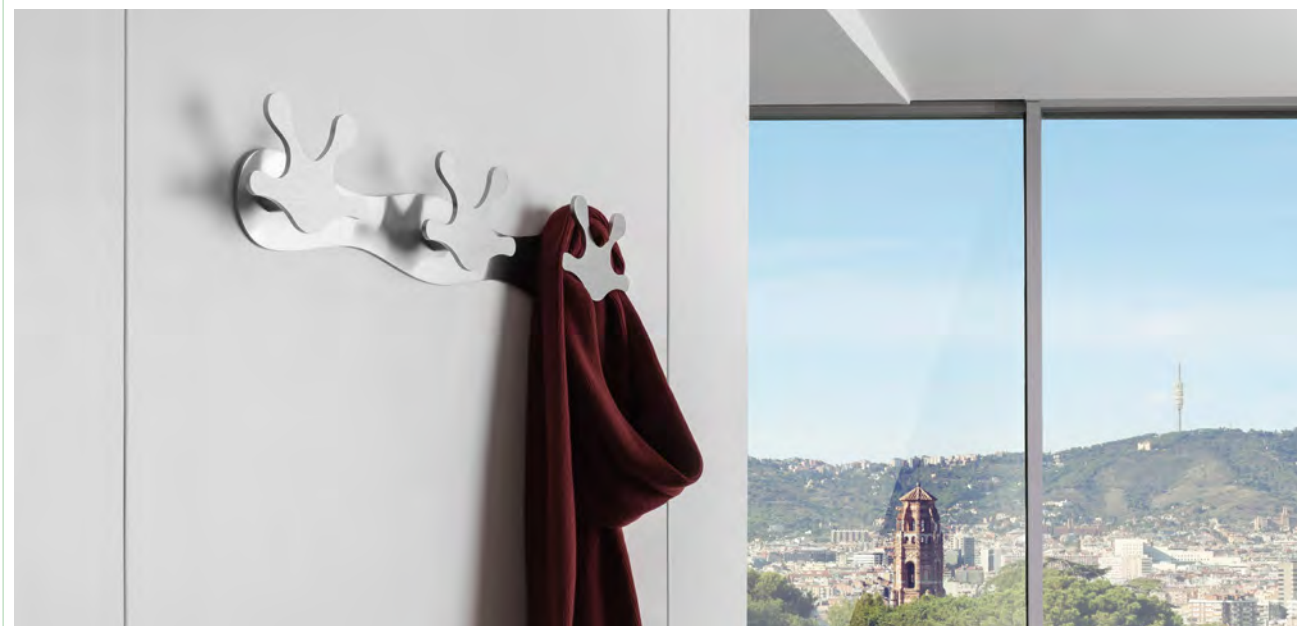

CABIDES E CRUZETAS / HOOKS AND HANGERS / PERCHAS

IN.14.533
 Cabide de pé /
 Floor hook /
 Percha de suelo.
 Design: Pedro Queirós

MATERIAL: EN 1.4301 / AISI 304

ACABAMENTO / FINISH / ACABADO:
 STANDARD: SATINADO / SATIN / SATIN

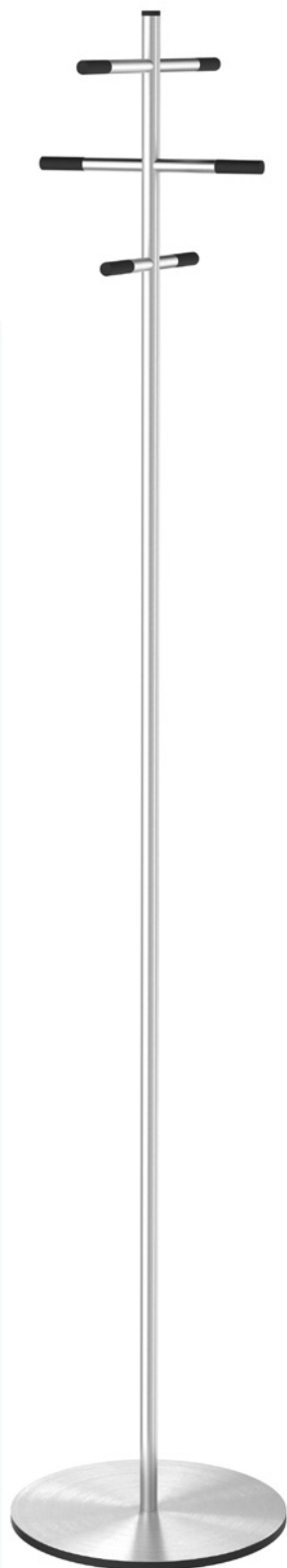
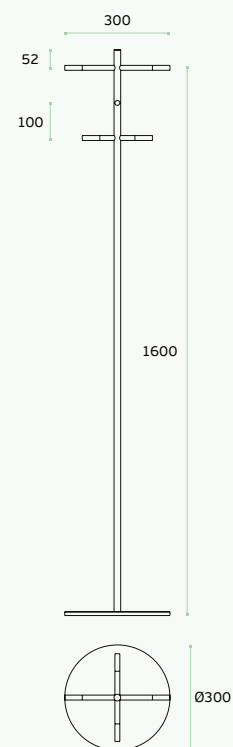

IN.23.410
 Cruzeta para hotel /
 Hotel cloth hanger / Percha para hotel.

MATERIAL: EN 1.4301 / AISI 304

ACABAMENTO / FINISH / ACABADO: STANDARD: SATINADO / SATIN / SATIN

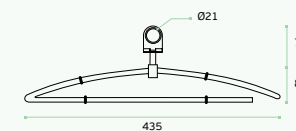

IN.23.411
 Cruzeta para hotel /
 Hotel cloth hanger / Percha para hotel.

MATERIAL: EN 1.4301 / AISI 304

ACABAMENTO / FINISH / ACABADO: STANDARD: SATINADO / SATIN / SATIN

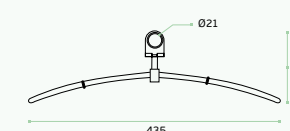

IN.23.412
 Cruzeta /
 Cloth hanger / Percha.

MATERIAL: EN 1.4301 / AISI 304

ACABAMENTO / FINISH / ACABADO: STANDARD: SATINADO / SATIN / SATIN

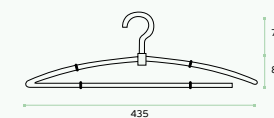

IN.23.413
 Cruzeta /
 Cloth hanger / Percha.

MATERIAL: EN 1.4301 / AISI 304

ACABAMENTO / FINISH / ACABADO: STANDARD: SATINADO / SATIN / SATIN

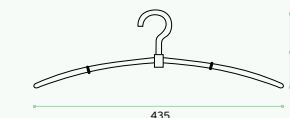

SUportes DE TUBO / TUBE SUPPORTS / SOPORTES DE TUBO



IN.23.600.16
IN.23.600.19
Tubo /
Tube / Tubo.

MATERIAL: EN 1.4301 / AISI 304

ACABAMENTO / FINISH / ACABADO: SATINADO / SATIN / SATIN

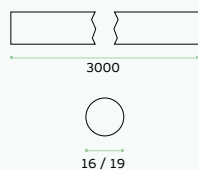

IN.23.600.25
Tubo /
Tube / Tubo.

MATERIAL: EN 1.4301 / AISI 304

ACABAMENTO / FINISH / ACABADO: SATINADO / SATIN / SATIN

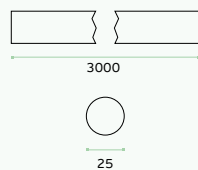

IN.23.544.16 (Ø16)
IN.23.544.19 (Ø19)
IN.15.016 (Ø25)
Terminal para aplicar no tubo **IN.23.600**
(Ø16/Ø19/Ø25) / Terminal to apply in tube
IN.23.600 (Ø16/Ø19/Ø25) / Terminal a aplicarse
en el tubo IN.23.600 (Ø16/Ø19/Ø25).

MATERIAL: EN 1.4301 / AISI 304

ACABAMENTO / FINISH / ACABADO: SATINADO / SATIN / SATIN

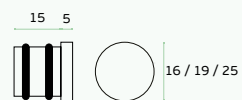

IN.23.542.16
IN.23.542.19
Suporte de tubo /
Tube support /
Soporte de tubo.

MATERIAL: EN 1.4301 / AISI 304

ACABAMENTO / FINISH / ACABADO: SATINADO / SATIN / SATIN

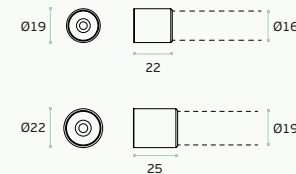

IN.23.543.16
IN.23.543.19
Suporte de tubo /
Tube support /
Soporte de tubo.

MATERIAL: EN 1.4301 / AISI 304

ACABAMENTO / FINISH / ACABADO: SATINADO / SATIN / SATIN

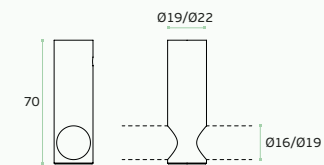

IN.23.545.16
IN.23.545.19
Suporte de tubo /
Tube support /
Soporte de tubo.

MATERIAL: EN 1.4301 / AISI 304

ACABAMENTO / FINISH / ACABADO: SATINADO / SATIN / SATIN

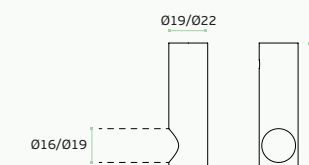

IN.23.550.70
IN.23.550.90
IN.23.550.110
Suporte de cortinas /
Curtains support / Soporte de cortinas.

MATERIAL: EN 1.4301 / AISI 304

ACABAMENTO / FINISH / ACABADO: SATINADO / SATIN / SATIN

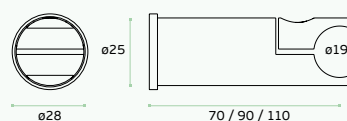

IN.23.551.70
IN.23.551.90
IN.23.551.110
Suporte de cortinas /
Curtains support / Soporte de cortinas.

MATERIAL: EN 1.4301 / AISI 304

ACABAMENTO / FINISH / ACABADO: SATINADO / SATIN / SATIN

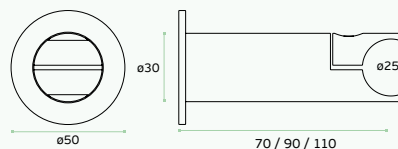

IN.23.552.19
IN.23.552.25
Terminal para aplicar no tubo **IN.23.600** (Ø19/
Ø25) / Terminal to apply in tube IN.23.600 (Ø19/
Ø25) / Terminal a aplicarse en el tubo IN.23.600
(Ø19/Ø25).

MATERIAL: EN 1.4301 / AISI 304

ACABAMENTO / FINISH / ACABADO: SATINADO / SATIN / SATIN

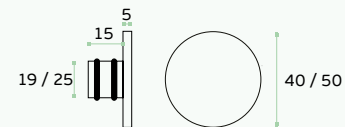

IN.43.590
Suporte de gravatas /
Tie support /
Soporte de corbatas

MATERIAL: EN 1.4301 / AISI 304

ACABAMENTO / FINISH / ACABADO: SATINADO / SATIN / SATIN

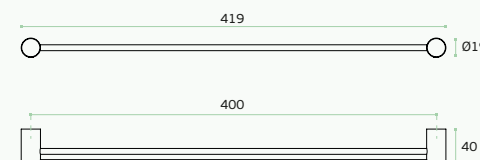

IN.23.414
Cabide com bloqueio /
Hook with locking /
Percha con cierre.

MATERIAL: EN 1.4301 / AISI 304

ACABAMENTO / FINISH / ACABADO: SATINADO / SATIN / SATIN

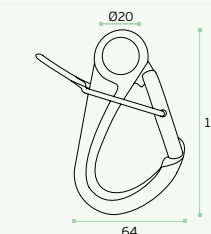

**FECHOS /
BOLTS / CIERRES.**



NEW



IN.17.605.1
Mecanismo de cremone /
Latch mechanism /
Mecanismo cremona.

MATERIAL: EN 1.4401 / AISI 316

ACABAMENTO / FINISH / ACABADO:
SATINADO / SATIN / SATIN

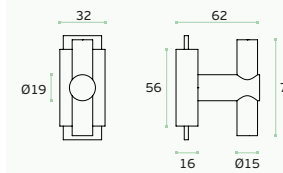

IN.17.605.1.KN
Mecanismo de cremone /
Latch mechanism /
Mecanismo cremona.

MATERIAL: EN 1.4401 / AISI 316

ACABAMENTO / FINISH / ACABADO:
SATINADO / SATIN / SATIN

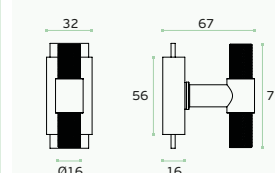

IN.17.607.1
Mecanismo de cremone /
Latch mechanism /
Mecanismo cremona.

MATERIAL: EN 1.4401 / AISI 316

ACABAMENTO / FINISH / ACABADO:
SATINADO / SATIN / SATIN

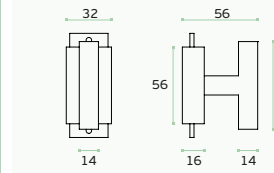

IN.17.608.1
Mecanismo de cremone /
Latch mechanism /
Mecanismo cremona.

MATERIAL: EN 1.4401 / AISI 316

ACABAMENTO / FINISH / ACABADO:
SATINADO / SATIN / SATIN

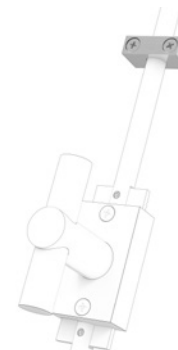
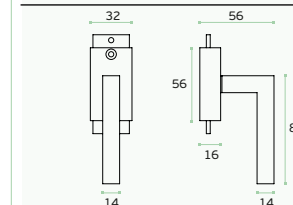

IN.17.605.2
Guia para vareta /
Window latch guide /
Guia para cremona de ventana.

MATERIAL: EN 1.4401 / AISI 316

ACABAMENTO / FINISH / ACABADO:
SATINADO / SATIN / SATIN

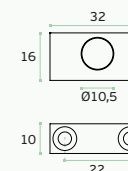

IN.17.607.2
Guia para vareta /
Window latch guide /
Guia para cremona de ventana.

MATERIAL: EN 1.4401 / AISI 316

ACABAMENTO / FINISH / ACABADO:
SATINADO / SATIN / SATIN

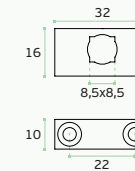

IN.17.605.10
IN.17.605.15
IN.17.605.30
Vareta redonda /
Round rod /
Vareta redonda.

MATERIAL: EN 1.4401 / AISI 316

ACABAMENTO / FINISH / ACABADO:
SATINADO / SATIN / SATIN

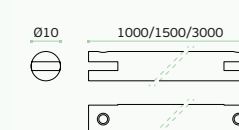

IN.17.607.10
IN.17.607.15
IN.17.607.30
Vareta quadrada /
Square rod /
Vareta cudrada.

MATERIAL: EN 1.4401 / AISI 316

ACABAMENTO / FINISH / ACABADO:
SATINADO / SATIN / SATIN

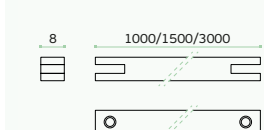

FECHOS / BOLTS / CIERRES.

IN.17.605.1



NEW

IN.17.605.1.KN



MÁX. 4000MM	MÁX. 3000MM	MÁX. 2500MM	MÁX. 2000MM	MÁX. 1500MM	MÁX. 1000MM
IN.17.605.1 (x1)	IN.17.605.1 (x1)	IN.17.605.1 (x1)	IN.17.605.1 (x1)	IN.17.605.1 (x1)	IN.17.605.1 (x1)
IN.17.605.2 (x10)	IN.17.605.2 (x9)	IN.17.605.2 (x8)	IN.17.605.2 (x8)	IN.17.605.2 (x6)	IN.17.605.2 (x6)
IN.17.605.10 (x1)	IN.17.605.30 (x1)	IN.17.605.10 (x1)	IN.17.605.10 (x2)	IN.17.605.15 (x1)	IN.17.605.10 (x1)
IN.17.605.30 (x1)	-	IN.17.605.15 (x1)	-	-	-

IN.17.607.1

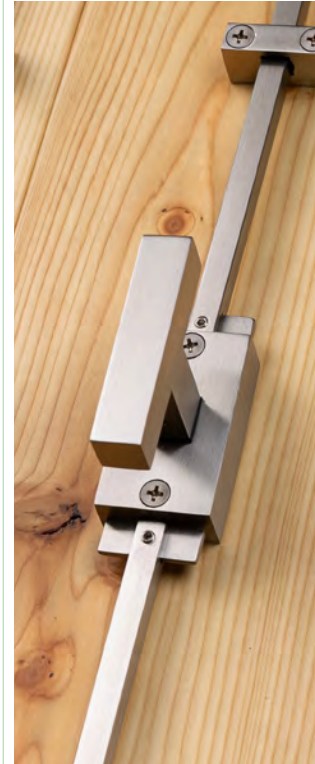

IN.17.608.1



MÁX. 4000MM	MÁX. 3000MM	MÁX. 2500MM	MÁX. 2000MM	MÁX. 1500MM	MÁX. 1000MM
IN.17.607.1 (x1)	IN.17.607.1 (x1)	IN.17.607.1 (x1)	IN.17.607.1 (x1)	IN.17.607.1 (x1)	IN.17.607.1 (x1)
IN.17.608.1 (x1)	IN.17.608.1 (x1)	IN.17.608.1 (x1)	IN.17.608.1 (x1)	IN.17.608.1 (x1)	IN.17.608.1 (x1)
IN.17.607.2 (x10)	IN.17.607.2 (x9)	IN.17.607.2 (x8)	IN.17.607.2 (x8)	IN.17.607.2 (x6)	IN.17.607.2 (x6)
IN.17.607.10 (x1)	IN.17.607.30 (x1)	IN.17.607.10 (x1)	IN.17.607.10 (x2)	IN.17.607.15 (x1)	IN.17.607.10 (x1)
IN.17.607.30 (x1)	-	IN.17.607.15 (x1)	-	-	-

FECHOS / BOLTS / CIERRES.

IN.17.601 Fecho / Bolt / Pasador

MATERIAL:
EN 1.4301 / AISI 304

**ACABAMENTO / FINISH /
ACABADO:**
SATINADO / SATIN / SATIN

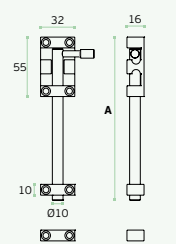

A
100/ 150/ 200/ 250/ 300/ 400/ 500/ 600/ 700/ 800/ 1000

2x
3x
4x



IN.17.612 HEAVY DUTY Fecho / Bolt / Pasador

MATERIAL:
EN 1.4301 / AISI 304

**ACABAMENTO / FINISH /
ACABADO:**
SATINADO / SATIN / SATIN

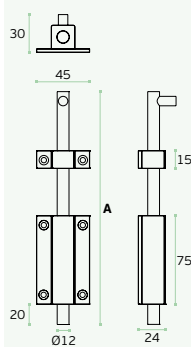

A
150 / 250 / 500



IN.17.613
Castanha
para fecho
IN.17.612 /
Strike for
IN.17.612 bolt
/ Encontra
para passador
IN.17.612.

IN.17.604 HEAVY DUTY Fecho / Bolt / Pasador

.TB .TG .TCO .TCH

MATERIAL:
EN 1.4301 / AISI 304

**ACABAMENTO / FINISH /
ACABADO:** SATIN

OPTIONAL:
PVD TITANIUM COATED

.TB / .TG / .TCO / .TCH

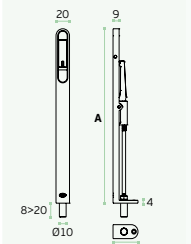

A
160 / 200 / 250



IN.17.401 Remate para fecho com mola / Bolt strike with spring / Cerradero de pasador con muelle.



Aplicável com / suitable
with / aplicable con:
IN.17.612

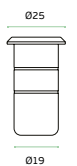

.P
Mirror
finish

.TB
PVD
Titanium
black

.TG
PVD
Titanium
gold

.TCO
PVD
Titanium
copper

.TCH
PVD
Titanium
chocolate

SM.035 SM.035.P Fecho / Bolt / Pasador.

MATERIAL: EN 1.4301 / AISI 304

ACABAMENTO / FINISH / ACABADO: SATINADO / SATIN / SATIN + POLIDO / POLISHED / PULIDO

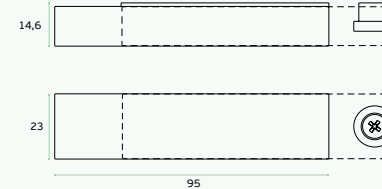
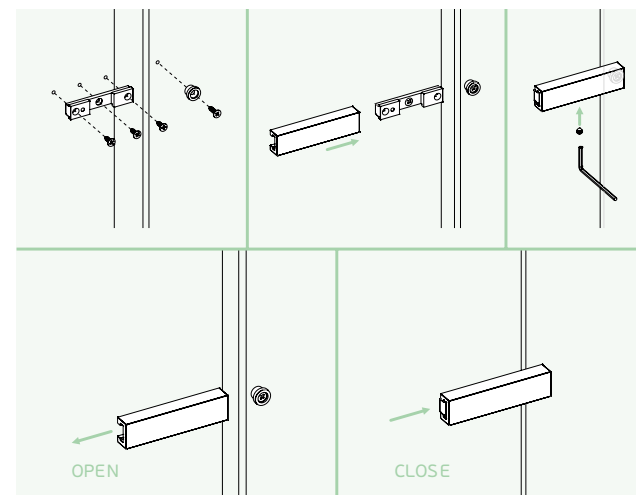

IN.17.010 Fecho magnético / Concealed magnetic latch / Cierre magnetico.

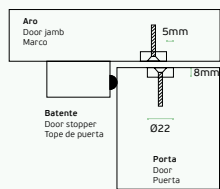

IN.17.210 Fecho limitador de segurança / Security / limiter latch / Cierre / limitador de seguridad.

.TB .TG .TCO .TCH

MATERIAL: EN 1.4301 / AISI 304

ACABAMENTO / FINISH / ACABADO: SATINADO / SATIN / SATIN

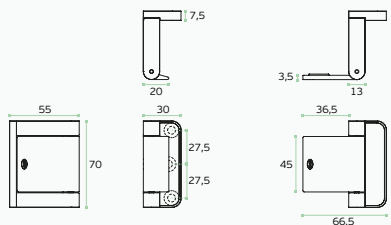

IN.17.400 Remate para fecho com mola / Bolt strike with spring / Cerradero de pasador con muelle.



Aplicável com / suitable
with / aplicable con:
IN.17.601 / 604



IN.24.129 Batente de porta / Door knocker / Llamador de puerta.

.TB .TG .TCO .TCH

MATERIAL: EN 1.4301 / AISI 304

ACABAMENTO / FINISH / ACABADO:
STANDARD: SATINADO / SATIN / SATIN

OPTIONAL: PVD TITANIUM COATED

.TB / .TG / .TCO / .TCH

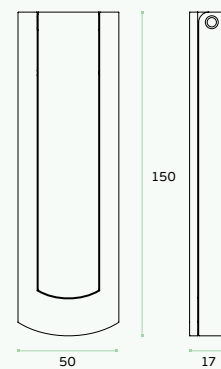

IN.24.129.TB
Titanium Black



IN.24.129.TG
Titanium Gold



IN.24.129.TCO
Titanium Copper



IN.24.129.TCH
Titanium Chocolate

VISORES DE PORTA / DOOR VIEWERS / MIRILLA DE PUERTA.

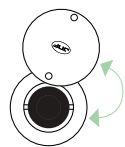

IN.23.010 LOOK SAFE
Visor de porta. (Lentes de cristal, corpo em aço inox) /
Door viewer. (Cristal lens, stainless steel body) /
Mirilla de puerta. (Lentes en cristal, cuerpo en acero inox).

.TB .TG .TCO .TCH

MATERIAL: EN 1.4301 / AISI 304

ACABAMENTO / FINISH / ACABADO:
STANDARD: SATINADO / SATIN / SATIN

OPTIONAL: PVD TITANIUM COATED

.TB / .TG / .TCO / .TCH

35 - 50MM

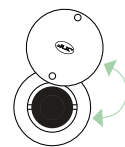
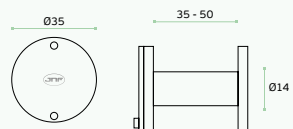

IN.23.010.B LOOK SAFE
Visor de porta. (Lentes de cristal, corpo em aço inox) /
Door viewer. (Cristal lens, stainless steel body) /
Mirilla de puerta. (Lentes en cristal, cuerpo en acero inox).

.TB .TG .TCO .TCH

MATERIAL: EN 1.4301 / AISI 304

ACABAMENTO / FINISH / ACABADO:
STANDARD: SATINADO / SATIN / SATIN

OPTIONAL: PVD TITANIUM COATED

.TB / .TG / .TCO / .TCH

51 - 80MM

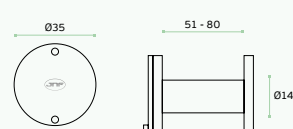

.P
Mirror
finish

.TB
PVD
Titanium
black

.TG
PVD
Titanium
gold

.TCO
PVD
Titanium
copper

.TCH
PVD
Titanium
chocolate

.P
Mirror
finish

.TB
PVD
Titanium
black

.TG
PVD
Titanium
gold

.TCO
PVD
Titanium
copper

.TCH
PVD
Titanium
chocolate

INTERRUPTORES / SWITCHES / INTERRUPTORES.



IN.24.201
Interruptor /
Switch /
Interruptor.

MATERIAL: EN 1.4301 / AISI 304

ACABAMENTO / FINISH / ACABADO:
SATINADO / SATIN / SATIN

MÁX: 12 VOLTS

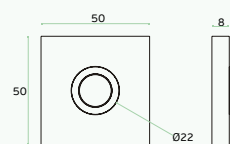

IN.24.204
Interruptor /
Switch /
Interruptor.

MATERIAL: EN 1.4301 / AISI 304

ACABAMENTO / FINISH / ACABADO:
SATINADO / SATIN / SATIN

MÁX: 12 VOLTS

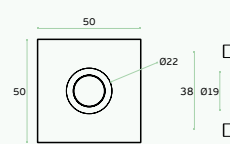

IN.24.205
Interruptor /
Switch /
Interruptor.

MATERIAL: EN 1.4301 / AISI 304

ACABAMENTO / FINISH / ACABADO:
SATINADO / SATIN / SATIN

MÁX: 12 VOLTS

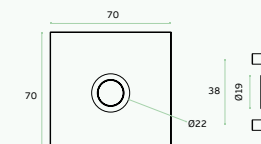

IN.24.209
Interruptor /
Switch /
Interruptor.

MATERIAL: EN 1.4301 / AISI 304

ACABAMENTO / FINISH / ACABADO:
SATINADO / SATIN / SATIN

MÁX: 12 VOLTS

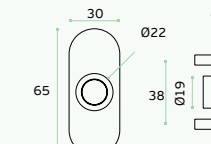

Lado exterior

Lente em vidro e plana /
Corpo em aço
inoxidável /
Ângulo de visão
de 200° /

Outside

Flat glass lens /
Stainless steel body /
Viewing Angle 200° /

Exterior

Lente de cristal plana /
Cuerpo en acero i
noxidable /
Ângulo de visión
de 200°



Escala / Scale
1:1

Lado interior

Tampa rotativa em aço
inoxidável /
Ajustável a diferentes
espessuras de porta /
Possibilidade de acaba-
mentos em titânio. /



Interior

Stainless steel
rotating cap /
Adjustable to different
door thicknesses /
Possibility of titanium
finishes /

Interior

Tampa rotativa em aço
inoxidável /
Ajustável a diferentes
espessuras de porta /
Posibilidad de acabados
en titanio



Escala / Scale
1:1



**IN.24.207 /
IN.24.208**
Interruptor / Switch / Interruptor.

MATERIAL: EN 1.4301 / AISI 304

ACABAMENTO / FINISH / ACABADO:
SATINADO / SATIN / SATIN

MÁX: 12 VOLTS

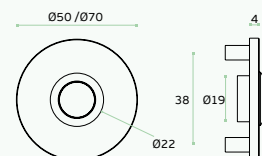

IN.24.203
Interruptor / Switch / Interruptor.

MATERIAL: EN 1.4301 / AISI 304

ACABAMENTO / FINISH / ACABADO:
SATINADO / SATIN / SATIN

MÁX: 12 VOLTS

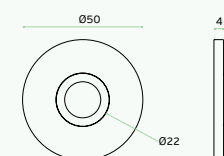

IN.24.206
Interruptor / Switch / Interruptor.

MATERIAL: EN 1.4301 / AISI 304

ACABAMENTO / FINISH / ACABADO:
SATINADO / SATIN / SATIN

MÁX: 12 VOLTS

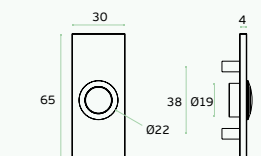

IN.24.202
Interruptor / Switch / Interruptor.

MATERIAL: EN 1.4301 / AISI 304

ACABAMENTO / FINISH / ACABADO:
SATINADO / SATIN / SATIN

MÁX: 12 VOLTS

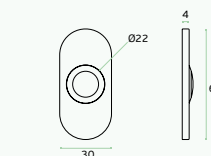

SUPORTES DE CORRIMÃO / HAND RAIL SUPPORTS / SOPORTES DE PASAMANOS



- 1** **Revestimento de superfície com propriedade anti microbial.**
Surface coating with anti microbial property. /
Revestimiento de superficie con propiedad antimicrobiana.
- 2** **Desenho ergonómico com arestas arredondadas.**
Ergonomic design with rounded edges. /
Diseño ergonómico con aristas redondeadas.
- 3** **Barra produzida em material facilmente higienizável, texturado e antiderrapante.**
Bar made of easily higienizable, textured and non-slip material. /
Barra fabricado en material fácilmente higienizado, texturado y antideslizante.
- 4** **Grande capacidade de carga (até 150kg).**
Large load capacity (up to 150kg). /
Gran capacidad de carga (hasta 150kg).
- 5** **Base de fixação robusta, em aço inoxidável (EN 1.4103)**
Sturdy wall mounting base in stainless steel (EN 1.4103) /
Base de fijación a la pared robusta, producida en acero inoxidable (EN 1.4103)

COMFORT SYSTEM

A GAMA COMFORT SYSTEM CRIA UMA PONTE ENTRE A FUNCIONALIDADE E O DESIGN, DISPONIBILIZANDO SOLUÇÕES CONFORTÁVEIS QUE PROPORCIONAM UM ELEVADO BEM-ESTAR, HIGIENE E SEGURANÇA A TODOS OS UTILIZADORES, SEM COMPROMETER O DESIGN DOS PRODUTOS QUE NELA SE INSEREM.

THE COMFORT SYSTEM RANGE CREATES A BRIDGE BETWEEN FUNCTIONALITY AND DESIGN, PROVIDING COMFORTABLE SOLUTIONS THAT PROVIDE HIGH WELL-BEING, HYGIENE, AND SAFETY TO ALL USERS, WITHOUT COMPROMISING THE DESIGN OF THE PRODUCTS THAT FALL WITHIN IT.

LA GAMA COMFORT SYSTEM CREA UN PUENTE ENTRE FUNCIONALIDAD Y DISEÑO, BRINDANDO SOLUCIONES CÓMODAS QUE BRINDAN UN ALTO NIVEL DE BIENESTAR, HIGIENE Y SEGURIDAD A TODOS LOS USUARIOS, SIN COMPROMETER EL DISEÑO DE LOS PRODUCTOS QUE LA INTEGRAN.

ANTIMICROBIAL

NEW

IN.18.008.M1

Kit barra de apoio com revestimento de superfície com propriedade antimicrobial. Contém 2 Suportes laterais e uma barra de apoio de 1500mm. / Support bar kit with surface coating with antimicrobial property. Contains 2 side supports and a 1500mm support bar. / Kit barra de soporte con revestimiento de superficie con propiedad antimicrobiana. Contiene 2 soportes laterales y una barra de soporte de 1500mm.

.TB .TG .TCO .TCH

MATERIAL: EN 1.4301 / AISI 304

ACABAMENTO / FINISH / ACABADO STANDARD: JNF
MICROSAFETM

ACABAMENTO / FINISH / ACABADO OPCIONAL:

.TB / .TCH / .TCO / .TG

ANTIMICROBIAL

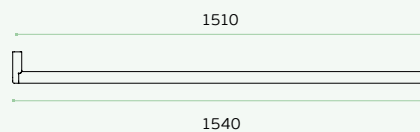

NEW

IN.18.008.M2

Kit barra de apoio com revestimento de superfície com propriedade antimicrobial. Contém 2 Suportes laterais, 1 Suporte intermédio e 2 barras de apoio de 1500mm. / Support bar kit with surface coating with antimicrobial property. Contains 2 side supports, 1 mid support and two 1500mm support bars. / Kit barra de soporte con revestimiento de superficie con propiedad antimicrobiana. Contiene 2 soportes laterales, 1 soporte intermédio y 2 barras de soporte de 1500mm.

.TB .TG .TCO .TCH

MATERIAL: EN 1.4301 / AISI 304

ACABAMENTO / FINISH / ACABADO STANDARD: JNF
MICROSAFETM

ACABAMENTO / FINISH / ACABADO OPCIONAL:

.TB / .TCH / .TCO / .TG

ANTIMICROBIAL

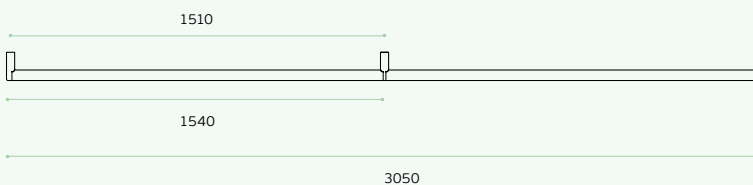

NEW

IN.18.008.M3

Kit barra de apoio com revestimento de superfície com propriedade antimicrobial. Contém 2 Suportes laterais, 2 Suportes intermédios e 3 barras de apoio de 1500mm. / Support bar kit with surface coating with antimicrobial property. Contains 2 side supports, 2 mid supports and three 1500mm support bars. / Kit barra de soporte con revestimiento de superficie con propiedad antimicrobiana. Contiene 2 soportes laterales, 2 soportes intermedios y 3 barras de soporte de 1500mm.

.TB .TG .TCO .TCH

MATERIAL: EN 1.4301 / AISI 304

ACABAMENTO / FINISH / ACABADO STANDARD: JNF
MICROSAFETM

ACABAMENTO / FINISH / ACABADO OPCIONAL:

.TB / .TCH / .TCO / .TG

ANTIMICROBIAL

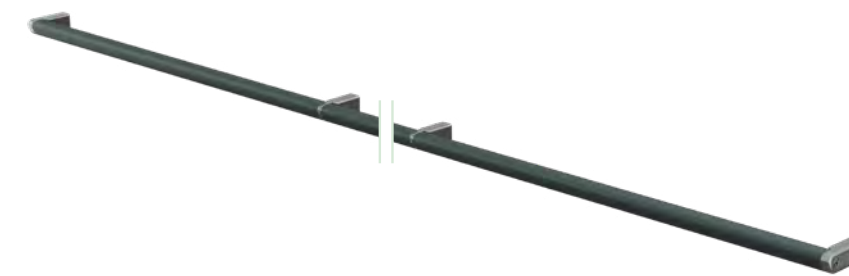

SUportes DE CORRIMÃO / HAND RAIL SUPPORTS / SOPORTES DE PASAMANOS

NEW

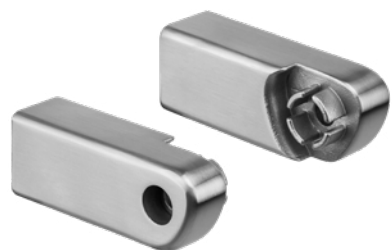

IN.18.008.A COMFORT SYSTEM
 Conjunto de Suportes com acabamento antimicrobial.
 Bracket set with antimicrobial finish /
 Juego de soportes con acabado antimicrobiano.

.TB .TG .TCO .TCH

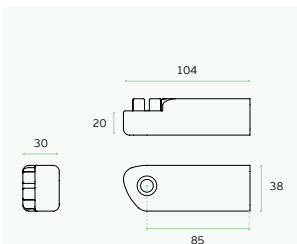
MATERIAL: EN 1.4301 / AISI 304

ACABAMENTO / FINISH / ACABADO:
 STANDARD: SATINADO / SATIN / SATIN

OPTIONAL: PVD TITANIUM COATED

.TB / .TG / .TCO / .TCH

ANTIMICROBIAL

NEW



IN.18.008.B COMFORT SYSTEM
 Suporte de corrimão intermédio com acabamento antimicrobial.

 Middle hand rail support with antimicrobial finish.
 Soporte de pasamanos intermédio con acabado antimicrobiano.

.TB .TG .TCO .TCH

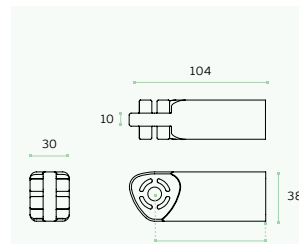
MATERIAL: EN 1.4301 / AISI 304

ACABAMENTO / FINISH / ACABADO:
 STANDARD: SATINADO / SATIN / SATIN

OPTIONAL: PVD TITANIUM COATED

.TB / .TG / .TCO / .TCH

ANTIMICROBIAL

NEW



IN.18.008.C COMFORT SYSTEM

Barra de apoio com revestimento de superfície com propriedade antimicrobial. Capacidade de carga até 150kg. / Grab bar with surface coating with antimicrobial property. Load capacity up to 150kg. / Barra de soporte con revestimiento de superficie con propiedad antimicrobiana. Capacidad de carga hasta 150kg. (Tamanho / Size: 500 / 1000 / 1500mm)

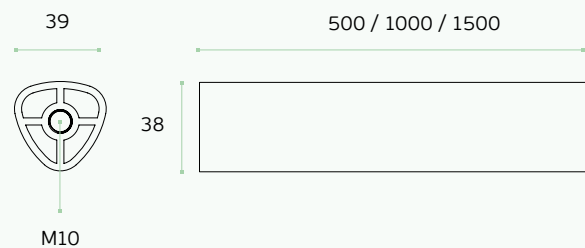
ACABAMENTO / FINISH / ACABADO:
 STANDARD: RAL 7011

JNF MICROSAFE™

.TMS

ANTIMICROBIAL

 .P
 Mirror
 finish

 .TB
 PVD
 Titanium
 black

 .TG
 PVD
 Titanium
 gold

 .TCO
 PVD
 Titanium
 copper

 .TCH
 PVD
 Titanium
 chocolate

SUPTES DE CORRIMÃO / HAND RAIL SUPPORTS / SOPORTES DE PASAMANOS

IN.18.133

Suporte de corrimão /
 Hand rail support / Soporte de pasamanos.

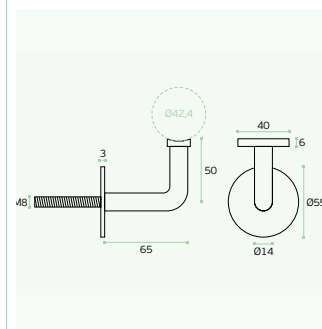

MATERIAL: EN 1.4301 / AISI 304

ACABAMENTO / FINISH / ACABADO:
 SATINADO / SATIN / SATIN

IN.18.134

Suporte de corrimão (parafuso M8) /
 Hand rail support (M8 screw) / Soporte de pasamanos (Tornillo M8).

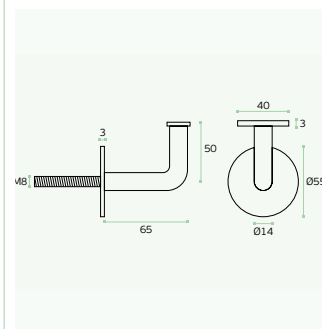

MATERIAL: EN 1.4301 / AISI 304

ACABAMENTO / FINISH / ACABADO:
 SATINADO / SATIN / SATIN

IN.18.135

Suporte de corrimão para vidro /
 Hand rail support for glass / Soporte de pasamanos para cristal.

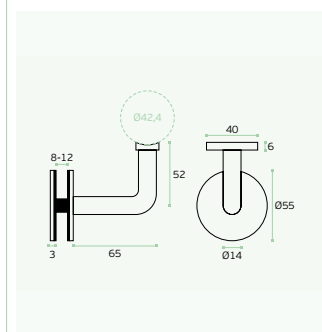

MATERIAL: EN 1.4301 / AISI 304

ACABAMENTO / FINISH / ACABADO:
 SATINADO / SATIN / SATIN

IN.18.136

Suporte de corrimão para vidro /
 Hand rail support for glass / Soporte de pasamanos para cristal.

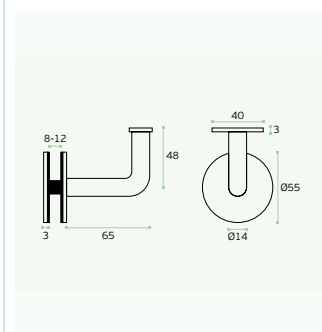

MATERIAL: NIQUEL / NICKEL

ACABAMENTO / FINISH / ACABADO:
 SATINADO / SATIN / SATIN

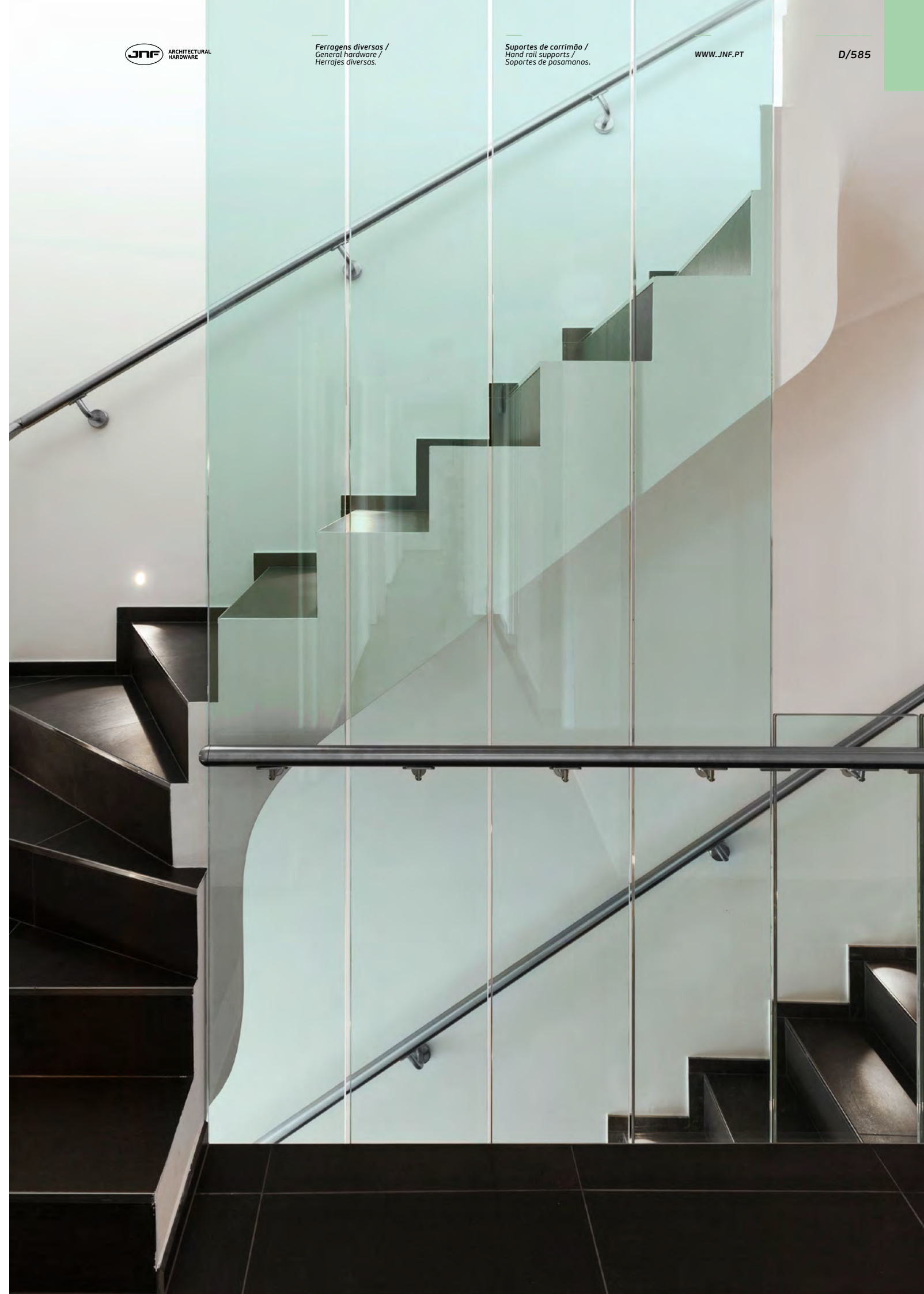

CAIXAS DE CORREIO / MAILBOXES / BUZÓN DE CORREO



IN.24.544

Caixa de correio com fixação à parede. Pode ser instalada no exterior. Abertura frontal para entrada de correio com tampa de proteção de chuva. Porta frontal para saída do correio com fechadura. / Mailbox with wall fixing. Possible to apply outside. Front opening for incoming mail with a protective cap for rain. Front door with lock to take out the mail / Buzón de correo con sujeción de pared. Posible aplicar en el exterior. Apertura frontal para el correo con una tapa protectora de la lluvia. Puerta de salida de correo con cerradura.

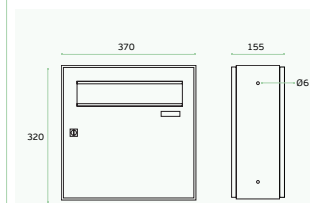

MATERIAL: EN 1.4301 / AISI 304

ACABAMENTO / FINISH / ACABADO:
STANDARD: SATINADO / SATIN / SATIN

INCLUI / INCLUDES / INCLUYE:
2 CHAVES / 2 KEYS / 2 LLAVES

EN13724 1341

IN.24.545

Caixa de correio pode ser instalada no exterior. Abertura frontal para entrada de correio com tampa de proteção de chuva. Porta traseira para saída do correio com fechadura. / Mailbox possible to apply outside. Front opening for incoming mail with a protective cap for rain. Back door with lock to take out the mail / Buzón de correo posible aplicar en el exterior. Apertura frontal para el correo con una tapa protectora de la lluvia. Puerta de correo con cerradura.

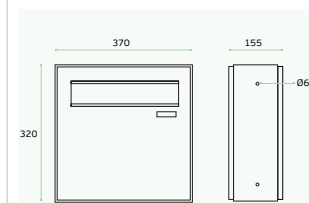

MATERIAL: EN 1.4301 / AISI 304

ACABAMENTO / FINISH / ACABADO:
STANDARD: SATINADO / SATIN / SATIN

INCLUI / INCLUDES / INCLUYE:
2 CHAVES / 2 KEYS / 2 LLAVES

EN13724 1341

.P
Mirror
finish

.TB
PVD
Titanium
black

.TG
PVD
Titanium
gold

.TCO
PVD
Titanium
copper

.TCH
PVD
Titanium
chocolate

IN.24.541

**Frente de correio /
Letter plate /
Frente de correo.**



.TB .TG .TCO .TCH

MATERIAL: EN 1.4301 / AISI 304

ACABAMENTO / FINISH / ACABADO:
STANDARD: SATINADO / SATIN / SATIN

OPTIONAL: PVD TITANIUM COATED

.TB / .TG / .TCO / .TCH

EN13724 4131

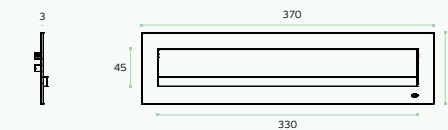
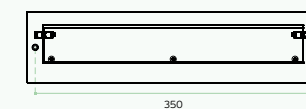

IN.24.540

**Frente de correio com mola /
Letter plate with spring /
Frente de correo con resorte.**



.TB .TG .TCO .TCH

MATERIAL: EN 1.4301 / AISI 304

ACABAMENTO / FINISH / ACABADO:
STANDARD: SATINADO / SATIN / SATIN

OPTIONAL: PVD TITANIUM COATED

.TB / .TG / .TCO / .TCH

EN13724 4131

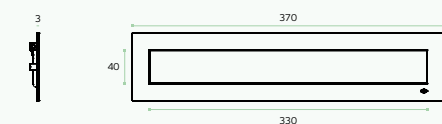
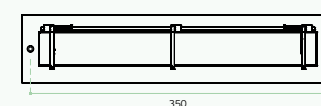

IN.24.547

**Frente de correio com mola /
Letter plate with spring /
Frente de correo con resorte.**



.TB .TG .TCO .TCH

MATERIAL: EN 1.4301 / AISI 304

ACABAMENTO / FINISH / ACABADO:
STANDARD: SATINADO / SATIN / SATIN

OPTIONAL: PVD TITANIUM COATED

.TB / .TG / .TCO / .TCH

EN13724 4131

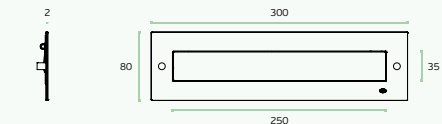

VENTILADORES / VENTILATORS/ REJILLAS.

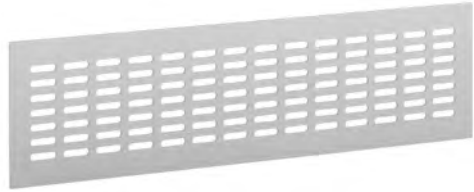

IN.23.033.A
Ventilador com fixação oculta /
 Ventilator with concealed fixing /
 Rejilla con sujeción oculta.

IN.23.033.P
Ventilador com fixação por parafuso /
 Ventilator with fixing screw /
 Rejilla con tornillo de sujeción.

MATERIAL: EN 1.4301 / AISI 304

ACABAMENTO / FINISH / ACABADO: STANDARD: SATINADO / SATIN / SATIN

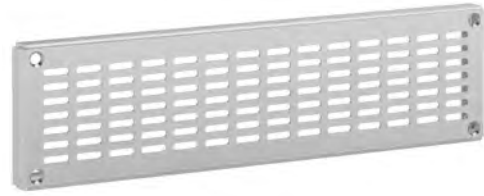
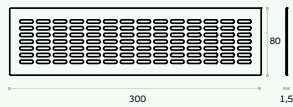

IN.23.033.Q HEAVY DUTY
Ventilador reforçado com fixação por parafuso.
Pode ser aplicado no pavimento /
 Reinforced ventilation grid with fixing screws.
 It can be installed on the floor /
 Rejilla reforzada con tornillo de sujeción.
 Se puede aplicar en el pavimento.

MATERIAL: EN 1.4301 / AISI 304

ACABAMENTO / FINISH / ACABADO: STANDARD: SATINADO / SATIN / SATIN

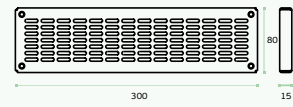

IN.23.035.A
Ventilador com fixação oculta /
 Ventilator with concealed fixing /
 Rejilla con sujeción oculta.

IN.23.035.P
Ventilador com fixação por parafuso /
 Ventilator with fixing screw /
 Rejilla con tornillo de sujeción.

MATERIAL: EN 1.4301 / AISI 304

ACABAMENTO / FINISH / ACABADO:
 STANDARD: SATINADO / SATIN / SATIN

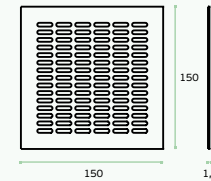

IN.23.035.Q HEAVY DUTY
Ventilador reforçado com fixação por parafuso.
Pode ser aplicado no pavimento /
 Reinforced ventilation grid with fixing screws.
 It can be installed on the floor /
 Rejilla reforzada con tornillo de sujeción.
 Se puede aplicar en el pavimento.

MATERIAL: EN 1.4301 / AISI 304

ACABAMENTO / FINISH / ACABADO:
 STANDARD: SATINADO / SATIN / SATIN

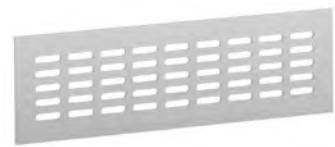
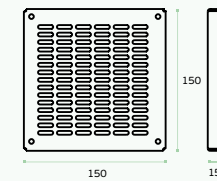

IN.23.034.A
Ventilador com fixação oculta /
 Ventilator with concealed fixing /
 Rejilla con sujeción oculta.

IN.23.034.P
Ventilador com fixação por parafuso /
 Ventilator with fixing screw /
 Rejilla con tornillo de sujeción.

MATERIAL: EN 1.4301 / AISI 304

ACABAMENTO / FINISH / ACABADO: STANDARD: SATINADO / SATIN / SATIN

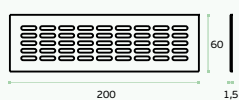

IN.23.034.Q HEAVY DUTY
Ventilador reforçado com fixação por parafuso.
Pode ser aplicado no pavimento /
 Reinforced ventilation grid with fixing screws.
 It can be installed on the floor /
 Rejilla reforzada con tornillo de sujeción.
 Se puede aplicar en el pavimento.

MATERIAL: EN 1.4301 / AISI 304

ACABAMENTO / FINISH / ACABADO: STANDARD: SATINADO / SATIN / SATIN

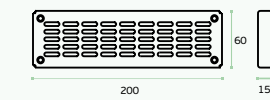

IN.23.028
Ventilador com fixação por parafuso /
 Ventilator with fixing screw /
 Rejilla con tornillo de sujeción.

MATERIAL: EN 1.4301 / AISI 304

ACABAMENTO / FINISH / ACABADO:
 STANDARD: SATINADO / SATIN / SATIN

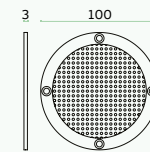

IN.23.029
Ventilador com fixação por parafuso /
 Ventilator with fixing screw /
 Rejilla con tornillo de sujeción.

MATERIAL: EN 1.4301 / AISI 304

ACABAMENTO / FINISH / ACABADO:
 STANDARD: SATINADO / SATIN / SATIN

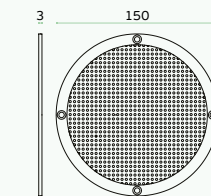

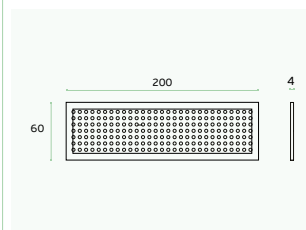
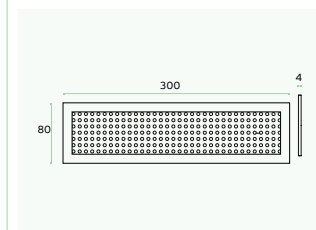
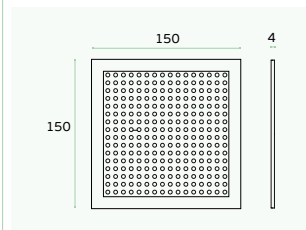
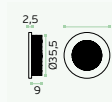
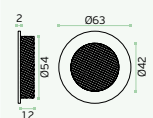
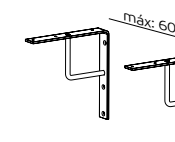
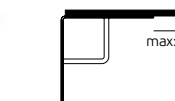
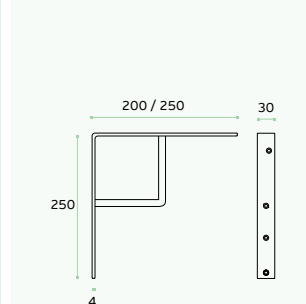
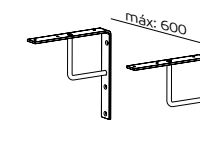
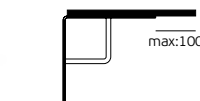
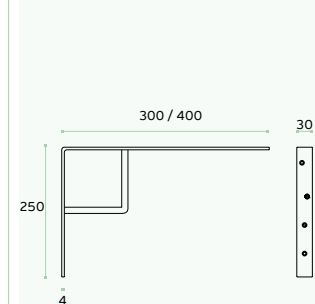
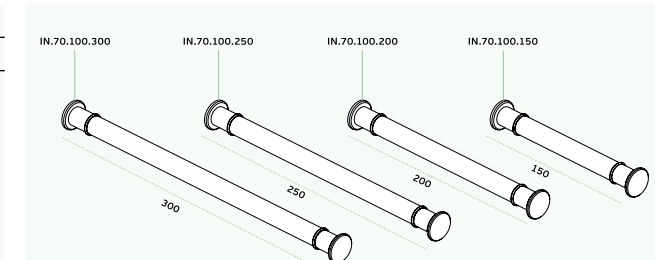
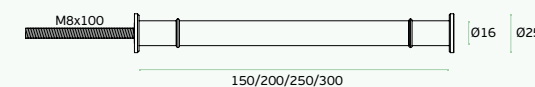
VENTILADORES /
VENTILATORS/ REJILLAS.**IN.23.030.A**
Ventilador com fixação oculta /
Ventilator with concealed fixing /
Rejilla con sujeción oculta.**IN.23.030.P**
Ventilador com fixação por parafuso /
Ventilator with fixing screw /
Rejilla con tornillo de sujeción.**MATERIAL:** EN 1.4301 / AISI 304
ACABAMENTO / FINISH / ACABADO:
STANDARD: SATINADO / SATIN / SATIN**IN.23.031.A**
Ventilador com fixação oculta /
Ventilator with concealed fixing /
Rejilla con sujeción oculta.**IN.23.031.P**
Ventilador com fixação por parafuso /
Ventilator with fixing screw /
Rejilla con tornillo de sujeción.**MATERIAL:** EN 1.4301 / AISI 304
ACABAMENTO / FINISH / ACABADO:
STANDARD: SATINADO / SATIN / SATIN**IN.23.032.A**
Ventilador com fixação oculta /
Ventilator with concealed fixing /
Rejilla con sujeción oculta.**IN.23.032.P**
Ventilador com fixação por parafuso /
Ventilator with fixing screw /
Rejilla con tornillo de sujeción.**MATERIAL:** EN 1.4301 / AISI 304
ACABAMENTO / FINISH / ACABADO:
STANDARD: SATINADO / SATIN / SATIN**IN.23.027.40**
Ventilador com fixação oculta /
Ventilator with concealed fixing /
Rejilla con sujeción oculta.**MATERIAL:** EN 1.4301 / AISI 304
ACABAMENTO / FINISH / ACABADO:
STANDARD: SATINADO / SATIN / SATIN**IN.23.027.63**
Ventilador com fixação oculta /
Ventilator with concealed fixing /
Rejilla con sujeción oculta.**MATERIAL:** EN 1.4301 / AISI 304
ACABAMENTO / FINISH / ACABADO:
STANDARD: SATINADO / SATIN / SATIN**SUPORTES PARA PRATELEIRA /**
SHELVES SUPPORTS / SOPORTES PARA BANDEJA.**IN.70.001.200**
IN.70.001.250
Cantoneira reforçada /
Reinforced shelf support /
Soporte de bandeja reforzado.**MATERIAL:** EN 1.4301 / AISI 304
ACABAMENTO / FINISH / ACABADO:
STANDARD: SATINADO / SATIN / SATIN**IN.70.001.300**
IN.70.001.400
Cantoneira reforçada /
Reinforced shelf support /
Soporte de bandeja reforzado.**MATERIAL:** EN 1.4301 / AISI 304
ACABAMENTO / FINISH / ACABADO:
STANDARD: SATINADO / SATIN / SATIN**IN.70.100.150**
IN.70.100.200
IN.70.100.250
IN.70.100.300
Suportes para prateleira /
Shelf supports / Soportes para bandeja.**MATERIAL:** EN 1.4301 / AISI 304
ACABAMENTO / FINISH / ACABADO: **STANDARD:** SATINADO / SATIN / SATIN

ARTEMIS

SISTEMA SUSPENSÃO MOLDURAS /
HANGING FRAMES SYSTEM /
SISTEMA DE SUSPENSIÓN DE CUADROS

ARTEMIS É UM SISTEMA DE SUSPENSÃO DE MOLDURAS PRÁTICO E FÁCIL DE USAR. O USO DE CALHAS NA PAREDE, CRIA UMA FLEXIBILIDADE QUE PERMITE A POSSIBILIDADE DE MOVER AS SUAS IMAGENS PARA QUALQUER LUGAR, CRIANDO UM NOVO ESPAÇO, UM NOVO VISUAL DE CADA VEZ.

ARTEMIS IS A PRACTICAL AND EASY TO USE FRAME SUSPENSION SYSTEM. THE USE OF RAILS ON THE WALL CREATES FLEXIBILITY THAT ALLOWS YOU TO MOVE YOUR IMAGES ANYWHERE, CREATING A NEW SPACE, A NEW LOOK EVERY TIME.

ARTEMIS ES UN SISTEMA DE SUSPENSIÓN DE MARCO PRÁCTICO Y FÁCIL DE USAR. EL USO DE CARRILES EN LA PARED CREA UNA FLEXIBILIDAD QUE PERMITE MOVER SUS IMÁGENES A CUALQUIER LUGAR, CREANDO UN NUEVO ESPACIO, UNA NUEVA APARIENCIA A LA VEZ.



NEW

IN.29.001.2000
ARTEMIS

Kit de perfil de alumínio para suspensão de molduras, com com fixações e tampas. Perfil de alumínio de 2000mm em cor branco e peso máximo até 25kg/m. Conector de perfil não incluído.

Kit of aluminum profile for hanging frames, with fixings and covers. 2000mm aluminum profile in white color and maximum weight up to 25kg/m. Profile connector not included.

Kit de perfil de alumínio para suspensión de cuadros, con fijaciones y cobiertas. Perfil de aluminio de 2000mm en color blanco y peso máximo hasta 25kg/m. Conector de perfil no incluido.

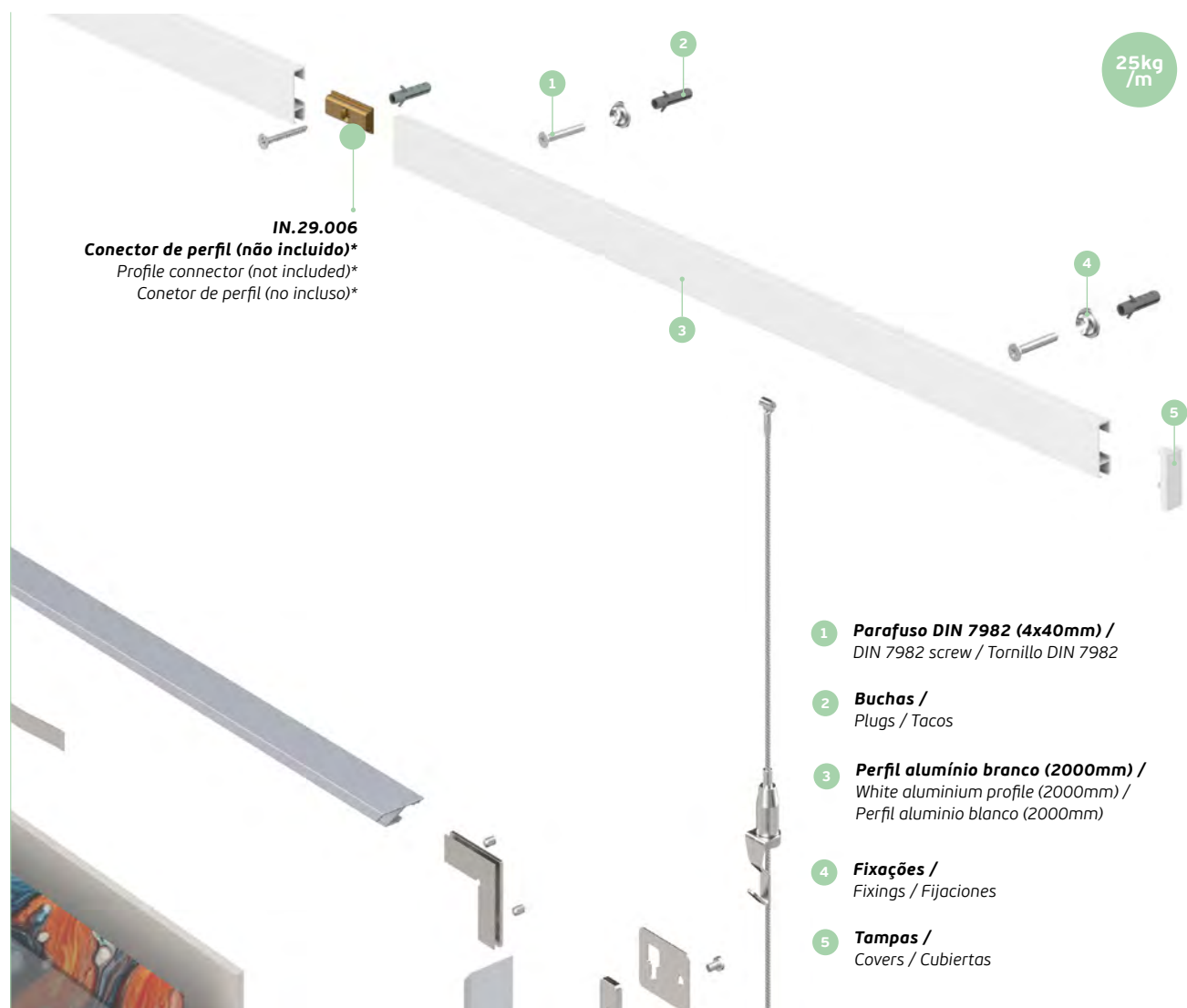

ARTEMIS

SISTEMA SUSPENSÃO MOLDURAS / HANGING FRAMES SYSTEM / SISTEMA DE SUSPENSIÓN DE CUADROS

NEW

IN.29.004
 ARTEMIS

Gancho para sistema de suspensão de molduras. Pode ser utilizado com cabo de aço ou de nylon. O gancho é retráctil e ajustável.

Hook for frame suspension system. Can be used with steel or nylon cable. The hook is retractable and adjustable /

Gancho para sistema de suspensión del cuadro. Se puede utilizar con cable de acero o nailon. El gancho es retráctil y ajustable.

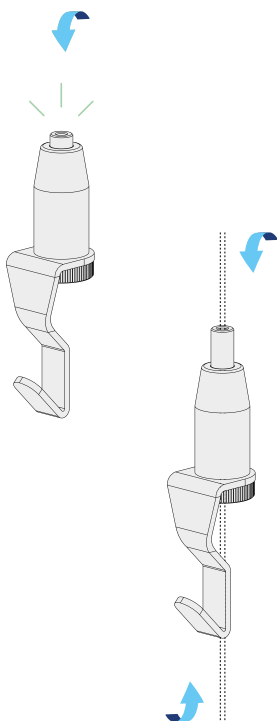

MATERIAL: LATÃO NIQUELADO

PESO / WEIGHT / PESO: 15KG (MÁX.)

NEW

IN.29.002.1820
IN.29.002.3000
 ARTEMIS

Sistema de suspensão com cabo de aço inox de 2mm. Dois tamanhos disponíveis (1820 e 3000mm). Peso máximo: 20kg.

Suspension system with 2mm stainless steel cable. Two available sizes (1820 and 3000mm). Maximum weight: 20kg.

Sistema de suspensión con cable de acero inoxidable de 2mm. Dos tamaños disponibles (1820 y 3000mm). Peso máximo: 20kg

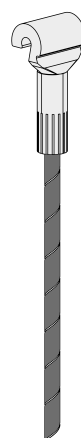

MATERIAL: EN 1.4301 / AISI 304

PESO / WEIGHT / PESO: 20KG (MÁX.)

NEW

IN.29.005
 ARTEMIS

Gancho de mola para sistema de suspensão de molduras. Pode ser utilizado com cabo de aço ou de nylon. O gancho é retráctil e ajustável.

Spring hook for frame suspension system. Can be used with steel or nylon cable. The hook is retractable and adjustable.

Gancho de muelle para sistema de suspensión del cuadro. Se puede utilizar con cable de acero o nailon. El gancho es retráctil y ajustable

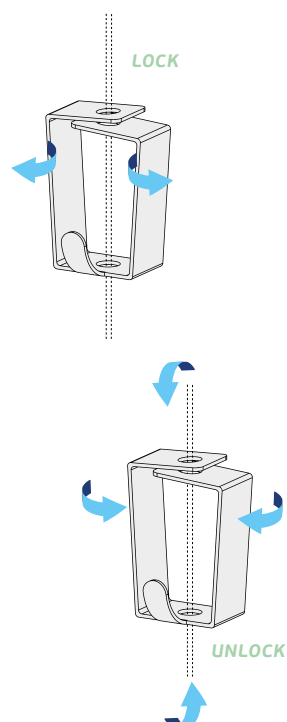

MATERIAL: AÇO NIQUELADO

PESO / WEIGHT / PESO: 3KG (MÁX.)

NEW

IN.29.003.1820
IN.29.003.3000
 ARTEMIS

Sistema de suspensão com cabo de nylon de 2mm. Dois tamanhos disponíveis (1820 e 3000mm). Peso máximo: 7kg.

Suspension system with 2mm nylon cable. Two available sizes (1820 and 3000mm). Maximum weight: 7kg.

Sistema de suspensión con cable de nylon de 2mm. Dos tamaños disponibles (1820 y 3000mm). Peso máximo: 7kg

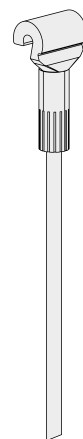

MATERIAL: NYLON

PESO / WEIGHT / PESO: 7KG (MÁX.)

1 Conecte o cabo ao perfil de alumínio.
 Connect the cable to aluminium profile / Conecte el cable al perfil de aluminio.

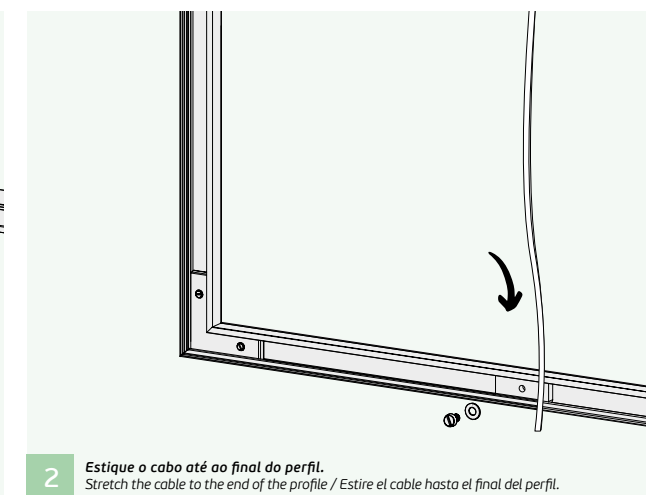
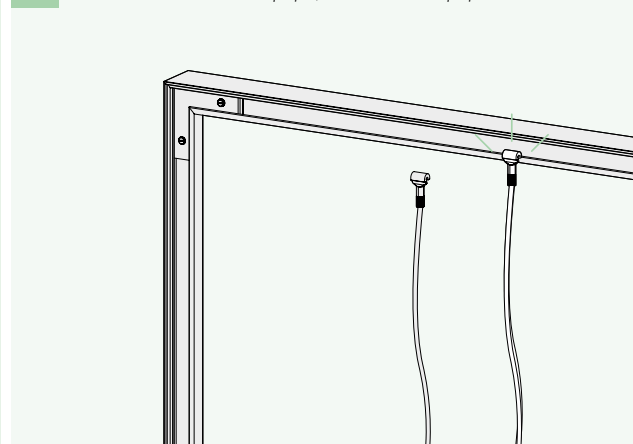

2 Estique o cabo até ao final do perfil.
 Stretch the cable to the end of the profile / Estire el cable hasta el final del perfil.

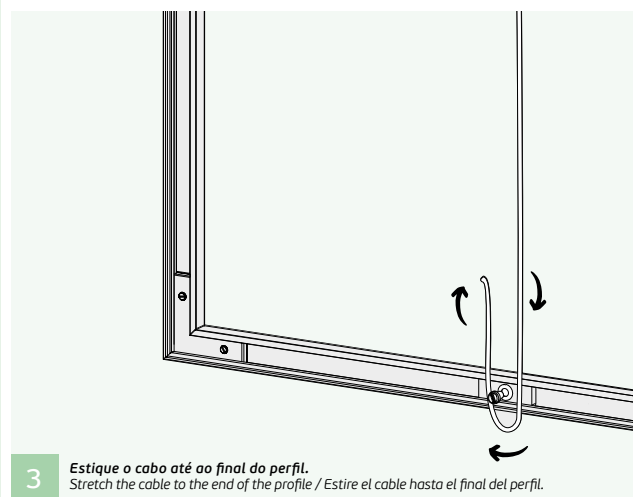

3 Estique o cabo até ao final do perfil.
 Stretch the cable to the end of the profile / Estire el cable hasta el final del perfil.

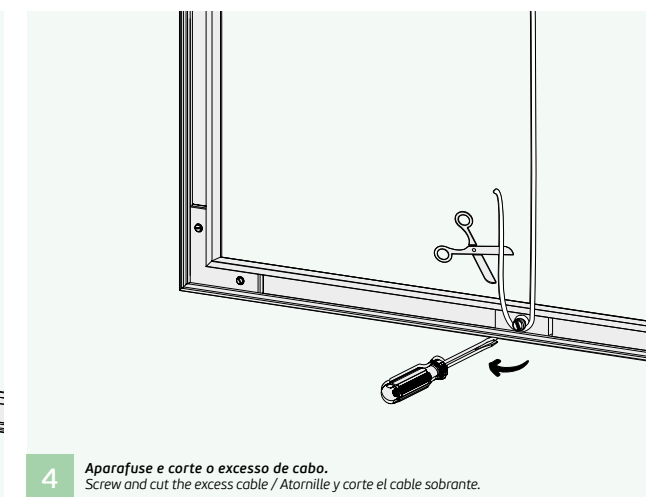

4 Aparafuse e corte o excesso de cabo.
 Screw and cut the excess cable / Atornille y corte el cable sobrante.

NEW

IN.29.012
 ARTEMIS

Kit estabilizador para o sistema de suspensão de molduras ARTEMIS. A sua utilização é necessária quando o comprimento X > 600mm. O kit inclui: IN.29.003.1820, IN.29.009.2 e parafuso DIN85 - M4x6.

Stabilizer kit for the ARTEMIS frame suspension system. Its use is necessary when the length X > 600mm. The kit includes: IN.29.003.1820, IN.29.009.2 and DIN85 - M4x6 screw.

Kit estabilizador para el sistema de suspensión del cuadro ARTEMIS. Su uso es necesario cuando la longitud X > 600 mm. El kit incluye: IN.29.003.1820, IN.29.009.2 y tornillo DIN85 - M4x6.

ARTEMIS

SISTEMA SUSPENSÃO MOLDURAS / HANGING FRAMES SYSTEM / SISTEMA DE SUSPENSIÓN DE CUADROS



NEW

IN.29.007.3000 ARTEMIS

Perfil em alumínio para moldura (3000mm) /
 Aluminum profile for frame (3000mm) /
 Perfil de aluminio para cuadro (3000mm).



NEW

IN.29.007.3000.B ARTEMIS

Perfil em alumínio lacado a preto para moldura (3000mm) /
 Black lacquered aluminum profile for frame (3000mm) /
 Perfil de aluminio lacado a negro para cuadro (3000mm).



IN.29.011 ARTEMIS

Kit completo para suspensão de molduras,
 com esquadros, Suporte para gancho/parede
 e molas de ajuste. O kit inclui: esquadros com
 parafuso DIN 551 (4 sets), Suporte de gancho
 de parede com parafuso DIN 85 (2 sets) e
 molas de ajuste (6 unidades).

Complete kit for frame suspension, with brackets,
 hook/wall support and adjustment springs. The
 kit includes: brackets with DIN 551 screws (4 sets),
 hook/wall bracket with DIN 85 screws (2 sets) and
 adjustment springs (6 units).

Kit completo para suspensión del cuadro, con
 esquadros, soporte de gancho/pared y resortes de
 ajuste. El kit inclui: soportes con tornillos DIN 551
 (4 sets), soporte de gancho/pared con tornillos DIN
 85 (2 sets) y resortes de ajuste (6 unidades).



1 Mola de ajuste /
 Adjustment spring /
 Resorte de ajuste

2 Esquadros /
 Brackets / Soportes

3 Suporte de gancho-parede /
 Hook-wall bracket /
 Soporte de gancho-pared



CABOS DE AÇO / WIRE ROPE / CABLE DE ACERO



2,5 mm

3 mm

4 mm

6 mm

8 mm

IN.10.722
Suporte de prateleira para cabo / Shelf support for wire / Soporte de bandeja para cable.

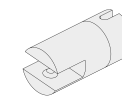

MATERIAL: EN 1.4301 / AISI 304

ACABAMENTO / FINISH / ACABADO: SATINADO / SATIN

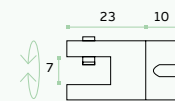

2,5 mm

3 mm

IN.10.723 (2,5 / 3mm)
IN.10.062 (4mm)
Suporte duplo de prateleira para cabo / Double shelf support for wire / Soporte doble de bandeja paracable.

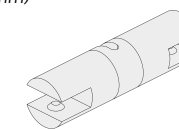

MATERIAL: EN 1.4301 / AISI 304

ACABAMENTO / FINISH / ACABADO: SATINADO / SATIN

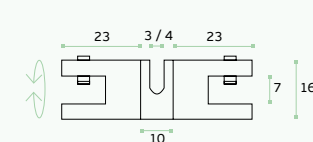

2,5 mm

3 mm

4 mm

IN.10.715
Suporte e esticador articulado / Articulated support / Soporte articulado

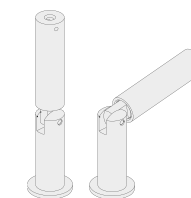

MATERIAL: EN 1.4301 / AISI 304

ACABAMENTO / FINISH / ACABADO: SATINADO / SATIN

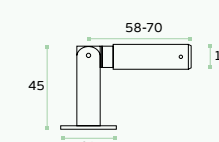

2,5 mm

3 mm

0°-180°

IN.10.720
Suporte de acrílico para cabo / Acrylic shelf support for wire / Soporte de bandeja de acrílico para cable.

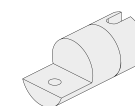

MATERIAL: EN 1.4301 / AISI 304

ACABAMENTO / FINISH / ACABADO: SATINADO / SATIN

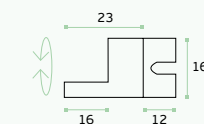

2,5 mm

3 mm

IN.10.721
Suporte duplo de acrílico para cabo / Double acrylic shelf support for wire / Soporte doble de bandeja de acrílico para cable.

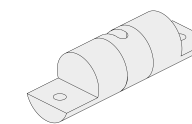

MATERIAL: EN 1.4301 / AISI 304

ACABAMENTO / FINISH / ACABADO: SATINADO / SATIN

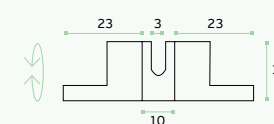

2,5 mm

3 mm

IN.10.716
Suporte e esticador / Support / Soporte.



MATERIAL: EN 1.4301 / AISI 304

ACABAMENTO / FINISH / ACABADO: SATINADO / SATIN

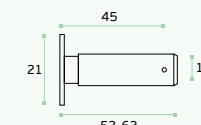

2,5 mm

3 mm