

G



**FERRAGENS PARA
MOBILIÁRIO /
FURNITURE
HARDWARE /
HERRAJES PARA
MUEBLE.**



PUXADORES DE MÓVEL / FURNITURE KNOBS / POMOS DE MUEBLE.



.P
Mirror finish

.TB
PVD Titanium black

.TG
PVD Titanium gold

.TCO
PVD Titanium copper

.TCH
PVD Titanium chocolate

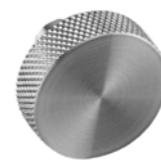

IN.22.160.30.KN WATCH
Puxador de móvel / Furniture knob / Pomo de mueble.



MATERIAL: EN 1.4301 / AISI 304
ACABAMENTO / FINISH ACABADO: SATINADO / SATIN
OPTIONAL: PVD TITANIUM COATED
.TB / .TG / .TCO / .TCH

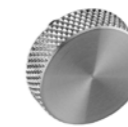
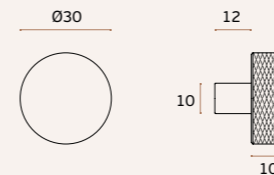

IN.22.160.25.KN WATCH
Puxador de móvel / Furniture knob / Pomo de mueble.



MATERIAL: EN 1.4301 / AISI 304
ACABAMENTO / FINISH ACABADO: SATINADO / SATIN
OPTIONAL: PVD TITANIUM COATED
.TB / .TG / .TCO / .TCH

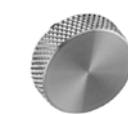
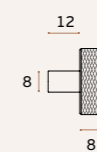

IN.22.160.20.KN WATCH
Puxador de móvel / Furniture knob / Pomo de mueble.



MATERIAL: EN 1.4301 / AISI 304
ACABAMENTO / FINISH ACABADO: SATINADO / SATIN
OPTIONAL: PVD TITANIUM COATED
.TB / .TG / .TCO / .TCH

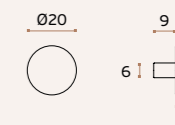

IN.22.135.KN WATCH
Puxador de móvel / Furniture knob / Pomo de mueble.



MATERIAL: EN 1.4301 / AISI 304
ACABAMENTO / FINISH ACABADO: SATINADO / SATIN / SATIN
OPTIONAL: PVD TITANIUM COATED
.TB / .TG / .TCO / .TCH

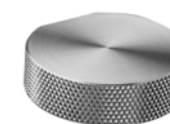
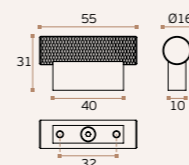

IN.22.162.KN WATCH
Puxador de móvel / Furniture knob / Pomo de mueble.



MATERIAL: EN 1.4301 / AISI 304
ACABAMENTO / FINISH ACABADO: SATINADO / SATIN / SATIN
OPTIONAL: PVD TITANIUM COATED
.TB / .TG / .TCO / .TCH

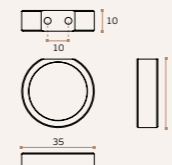

IN.22.152.16.KN NATUR WATCH
Puxador de móvel / Furniture knob / Pomo de mueble.



MATERIAL: EN 1.4301 / AISI 304
ACABAMENTO / FINISH ACABADO: SATINADO / SATIN / SATIN
OPTIONAL: PVD TITANIUM COATED
.TB / .TG / .TCO / .TCH

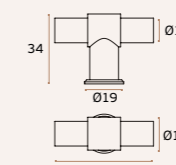

IN.22.152.14.KN NATUR WATCH
Puxador de móvel / Furniture knob / Pomo de mueble.



MATERIAL: EN 1.4301 / AISI 304
ACABAMENTO / FINISH ACABADO: SATINADO / SATIN / SATIN
OPTIONAL: PVD TITANIUM COATED
.TB / .TG / .TCO / .TCH

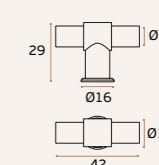

PUXADORES DE MÓVEL / FURNITURE KNOBS / POMOS DE MUEBLE.

NEW



IN.17.135.KN WATCH
Levanta janelas de guilhotina / Lift up window handle / Levanta ventanas de guillotina.

.TB .TG .TCO .TCH

MATERIAL: EN 1.4301 / AISI 304

ACABAMENTO / FINISH ACABADO: SATINADO / SATIN / SATIN

OPTIONAL: PVD TITANIUM COATED

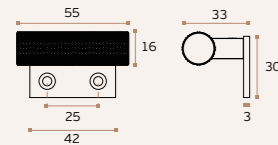

IMAGE / IMAGEM: IN.17.135.KN

.P
Mirror finish

.TB
PVD Titanium black

.TG
PVD Titanium gold

.TCO
PVD Titanium copper

.TCH
PVD Titanium chocolate

.P
Mirror finish

.TB
PVD Titanium black

.TG
PVD Titanium gold

.TCO
PVD Titanium copper

.TCH
PVD Titanium chocolate

IN.22.130
Puxador de móvel / Furniture knob / Pomo de mueble.

.TB .TG .TCO .TCH

MATERIAL: EN 1.4301 / AISI 304

ACABAMENTO / FINISH / ACABADO: STANDARD: SATINADO / SATIN / SATIN

OPTIONAL: PVD TITANIUM COATED

IN.22.131
Puxador de móvel / Furniture knob / Pomo de mueble.

.TB .TG .TCO .TCH

MATERIAL: EN 1.4301 / AISI 304

ACABAMENTO / FINISH / ACABADO: STANDARD: SATINADO / SATIN / SATIN

OPTIONAL: PVD TITANIUM COATED



IN.22.130.TB
Titanium black



IN.22.131.TG
Titanium gold

NEW

NEW

NEW

NEW

NEW

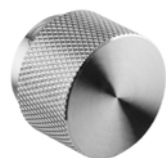

IN.22.161.30.KN
WATCH
Puxador de móvel / Furniture knob / Pomo de mueble.

.TB .TG .TCO .TCH

MATERIAL: EN 1.4301 / AISI 304

ACABAMENTO / FINISH: SATINADO / SATIN / SATIN

OPTIONAL: PVD TITANIUM

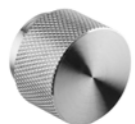
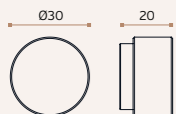

IN.22.161.25.KN
WATCH
Puxador de móvel / Furniture knob / Pomo de mueble.

.TB .TG .TCO .TCH

MATERIAL: EN 1.4301 / AISI 304

ACABAMENTO / FINISH: SATINADO / SATIN / SATIN

OPTIONAL: PVD TITANIUM

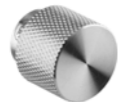
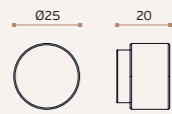

IN.22.161.20.KN
WATCH
Puxador de móvel / Furniture knob / Pomo de mueble.

.TB .TG .TCO .TCH

MATERIAL: EN 1.4301 / AISI 304

ACABAMENTO / FINISH: SATINADO / SATIN / SATIN

OPTIONAL: PVD TITANIUM

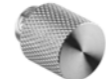
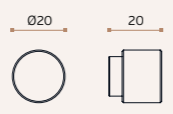

IN.22.161.15.KN
WATCH
Puxador de móvel / Furniture knob / Pomo de mueble.

.TB .TG .TCO .TCH

MATERIAL: EN 1.4301 / AISI 304

ACABAMENTO / FINISH: SATINADO / SATIN / SATIN

OPTIONAL: PVD TITANIUM

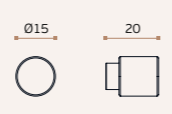

IN.22.161.10.KN
WATCH
Puxador de móvel / Furniture knob / Pomo de mueble.

.TB .TG .TCO .TCH

MATERIAL: EN 1.4301 / AISI 304

ACABAMENTO / FINISH: SATINADO / SATIN / SATIN

OPTIONAL: PVD TITANIUM

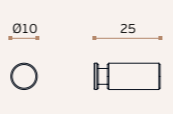

IN.22.132
Puxador de móvel / Furniture knob / Pomo de mueble.

.TB .TG .TCO .TCH

MATERIAL: EN 1.4301 / AISI 304

ACABAMENTO / FINISH / ACABADO: STANDARD: SATINADO / SATIN / SATIN

OPTIONAL: PVD TITANIUM COATED

IN.22.133 WATCH
Puxador de móvel / Furniture knob / Pomo de mueble.

.TB .TG .TCO .TCH

MATERIAL: EN 1.4301 / AISI 304

ACABAMENTO / FINISH / ACABADO: STANDARD: SATINADO / SATIN / SATIN

OPTIONAL: PVD TITANIUM COATED



IN.22.132.TCO
Titanium copper



IN.22.133.TCH
Titanium chocolate

PUXADORES DE MÓVEL / FURNITURE KNOBS / POMOS DE MUEBLE.

NEW



IN.22.490.C DUTCH OAK
Puxador de móvel /
Furniture knob /
Pomo de mueble.

.TB .TG .TCO .TCH

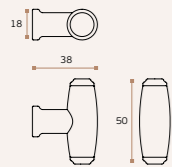

MATERIAL: EN 1.4301 / AISI 304

ACABAMENTO / FINISH / ACABADO:
STANDARD: SATINADO / SATIN / SATIN

OPTIONAL: PVD TITANIUM COATED

.TB / .TG / .TCO / .TCH

MATERIAL: CHRISTIAN MAGALHÃES



IN.22.490.BE
Birch wood



IN.22.490.BB
Bamboo wood



IN.22.490.BW
Black wood



IN.22.490.OP1
Acetate - Optic 1



IN.22.490.OP2
Acetate - Optic 2

.P
Mirror
finish

.TB
PVD
Titanium
black

.TG
PVD
Titanium
gold

.TCO
PVD
Titanium
copper

.TCH
PVD
Titanium
chocolate



NEW



IN.22.470.128.P ART DECO
Puxador de móvel /
Furniture knob /
Pomo de mueble.

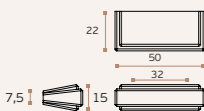

MATERIAL: EN 1.4301 / AISI 304

ACABAMENTO / FINISH / ACABADO:
STANDARD: SATINADO / SATIN / SATIN

OPTIONAL: POLIDO / POLISHED /

PULIDO .P

PVD TITANIUM COATED

.TB / .TG / .TCO / .TCH

SOLID ■

NEW



IN.22.470.P ART DECO
Puxador de móvel /
Furniture knob /
Pomo de mueble.



MATERIAL: EN 1.4301 / AISI 304

ACABAMENTO / FINISH / ACABADO:
STANDARD: SATINADO / SATIN / SATIN

OPTIONAL: POLIDO / POLISHED /

PULIDO .P

PVD TITANIUM COATED

.TB / .TG / .TCO / .TCH

SOLID ■



PUXADORES DE MÓVEL / FURNITURE KNOBS / POMOS DE MUEBLE.

NEW

IN.22.165.KN. WATCH LEATHER

Asa de móvel /
Furniture handle /
Tirador de mueble
Design: Pedro Queirós

.TB .TG .TCO .TCH

MATERIAL: EN 1.4301 / AISI 304 +
PELE NATURAL / NATURAL LEATHER /
CUERO NATURAL

ACABAMENTO / FINISH / ACABADO:
STANDARD: SATINADO / SATIN / SATIN

OPTIONAL: PVD TITANIUM COATED

.TB / .TG / .TCO / .TCH

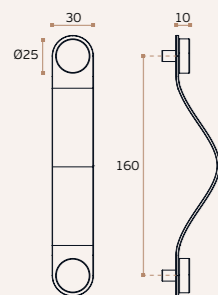

SOLID ■



IN.22.165.KN.B

Asa de móvel - Pele natural castanha /
Furniture handle - Natural Brown leather /
Tirador de mueble - Cuero natural marrón.



IN.22.165.KN.C

Asa de móvel - Pele natural camel /
Furniture handle - Natural camel leather /
Tirador de mueble - Cuero natural camel.



IN.22.165.KN.N

Asa de móvel - Pele natural preta /
Furniture handle - Natural Black leather /
Tirador de mueble - Cuero natural Negro.

.P
Mirror
finish

.TB
PVD
Titanium
black

.TG
PVD
Titanium
gold

.TCO
PVD
Titanium
copper

.TCH
PVD
Titanium
chocolate

.P
Mirror
finish

.TB
PVD
Titanium
black

.TG
PVD
Titanium
gold

.TCO
PVD
Titanium
copper

.TCH
PVD
Titanium
chocolate

SR.22.004. SKIN (Ø30mm)

Puxador de móvel /
Furniture knob /
Pomo de mueble.

.TB .TG .TCO .TCH

MATERIAL: EN 1.4301 / AISI 304 +
PELE NATURAL / NATURAL LEATHER /
CUERO NATURAL

ACABAMENTO / FINISH / ACABADO:
STANDARD: SATINADO / SATIN / SATIN

OPTIONAL: PVD TITANIUM COATED

.TB / .TG / .TCO / .TCH

DESIGN: SUSANA RIBEIRO

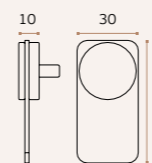

SOLID ■



SR.22.004.B SKIN Ø30

Asa de móvel - Pele natural castanha /
Furniture handle - Natural Brown leather /
Tirador de mueble - Cuero natural marrón.



SR.22.004.C SKIN Ø30

Asa de móvel - Pele natural camel /
Furniture handle - Natural camel leather /
Tirador de mueble - Cuero natural camel.



SR.22.004.N SKIN Ø30

Asa de móvel - Pele natural preta /
Furniture handle - Natural Black leather /
Tirador de mueble - Cuero natural Negro.



NATURAL LEATHER
Castanha / Brown / Marrón.



NATURAL LEATHER
Camel



NATURAL LEATHER
Negro / Black / Negro.

NEW

IN.22.166.KN. WATCH LEATHER

Asa de móvel /
Furniture handle /
Tirador de mueble.
Design: Pedro Queirós

.TB .TG .TCO .TCH

MATERIAL: EN 1.4301 / AISI 304 +
PELE NATURAL / NATURAL LEATHER /
CUERO NATURAL

ACABAMENTO / FINISH / ACABADO:
STANDARD: SATINADO / SATIN / SATIN

OPTIONAL: PVD TITANIUM COATED

.TB / .TG / .TCO / .TCH

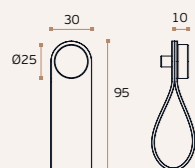

SOLID ■



NATURAL LEATHER
Castanha / Brown / Marrón.

IN.22.166.KN.B

Asa de móvel - Pele natural castanha /
Furniture handle - Natural Brown leather /
Tirador de mueble - Cuero natural marrón.



NATURAL LEATHER
Camel

IN.22.166.KN.C

Asa de móvel - Pele natural camel /
Furniture handle - Natural camel leather /
Tirador de mueble - Cuero natural camel.



NATURAL LEATHER
Negro / Black / Negro.

IN.22.166.KN.N

Asa de móvel - Pele natural preta /
Furniture handle - Natural Black leather /
Tirador de mueble - Cuero natural Negro.

SR.22.005. SKIN (Ø20mm)

Puxador de móvel /
Furniture knob /
Pomo de mueble.

.TB .TG .TCO .TCH

MATERIAL: EN 1.4301 / AISI 304 +
PELE NATURAL / NATURAL LEATHER /
CUERO NATURAL

ACABAMENTO / FINISH / ACABADO:
STANDARD: SATINADO / SATIN / SATIN

OPTIONAL: PVD TITANIUM COATED

.TB / .TG / .TCO / .TCH

DESIGN: SUSANA RIBEIRO

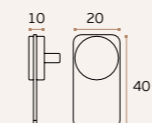

SOLID ■



SR.22.005.B SKIN Ø20

Asa de móvel - Pele natural castanha /
Furniture handle - Natural Brown leather /
Tirador de mueble - Cuero natural marrón.



SR.22.005.C SKIN Ø20

Asa de móvel - Pele natural camel /
Furniture handle - Natural camel leather /
Tirador de mueble - Cuero natural camel.



SR.22.005.N SKIN Ø20

Asa de móvel - Pele natural preta /
Furniture handle - Natural Black leather /
Tirador de mueble - Cuero natural Negro.



NATURAL LEATHER
Castanha / Brown / Marrón.



NATURAL LEATHER
Camel



NATURAL LEATHER
Negro / Black / Negro.

PUXADORES DE MÓVEL / FURNITURE KNOBS / POMOS DE MUEBLE.



IMAGE / IMAGEM: IN.22.105.TCO

IN.22.119.
Puxador de móvel / Furniture knob / Pomo de mueble.

- .TB
- .TG
- .TCO
- .TCH



.P
Mirror finish

.TB
PVD Titanium black

.TG
PVD Titanium gold

.TCO
PVD Titanium copper

.TCH
PVD Titanium chocolate

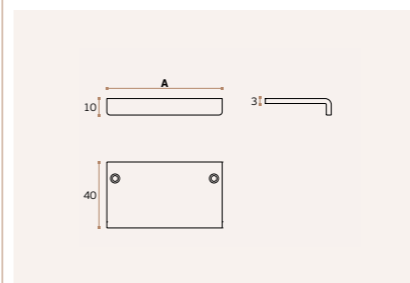

MATERIAL: EN 1.4301 / AISI 304

ACABAMENTO / FINISH / ACABADO:
STANDARD: SATINADO / SATIN / SATIN

A
30
70
250

AM.22.010
TOUCH IT
Puxador de móvel / Furniture knob / Pomo de mueble.



MATERIAL: EN 1.4301 / AISI 304

ACABAMENTO / FINISH / ACABADO:
STANDARD: SATINADO / SATIN / SATIN

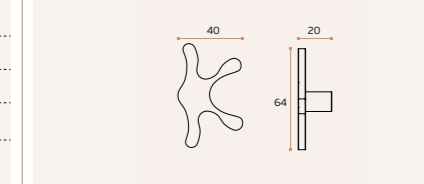

IN.22.105
Puxador de móvel / Furniture knob / Pomo de mueble.

- .TB
- .TG
- .TCO
- .TCH



MATERIAL: EN 1.4301 / AISI 304

ACABAMENTO / FINISH / ACABADO: STANDARD: SATINADO / SATIN / SATIN

OPTIONAL: PVD TITANIUM COATED

.TB / .TG / .TCO / .TCH

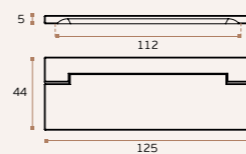

IN.22.103
Puxador de móvel / Furniture knob / Pomo de mueble.



MATERIAL: EN 1.4301 / AISI 304

ACABAMENTO / FINISH / ACABADO: STANDARD: SATINADO / SATIN / SATIN

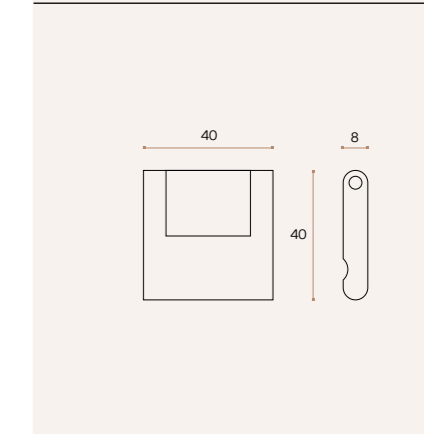

PUXADORES DE MÓVEL / FURNITURE KNOBS / POMOS DE MUEBLE.

IN.22.118.19

Puxador de móvel /
Furniture knob /
Pomo de mueble.

MATERIAL: EN 1.4301 / AISI 304

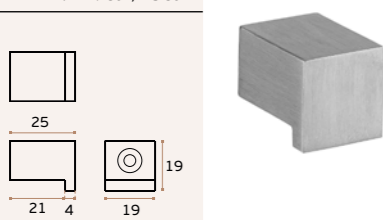

IN.22.118.12

Puxador de móvel /
Furniture knob /
Pomo de mueble.

MATERIAL: EN 1.4301 / AISI 304

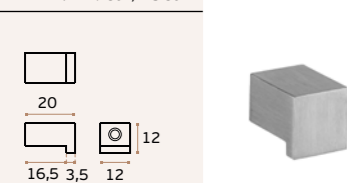

IN.22.125.20 TRAIN

Puxador de móvel /
Furniture knob /
Pomo de mueble.

MATERIAL: EN 1.4301 / AISI 304

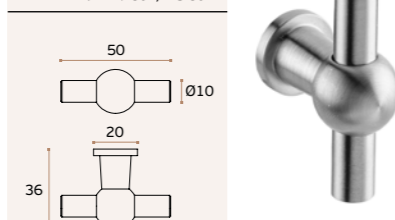

IN.22.125.18 TRAIN

Puxador de móvel /
Furniture knob /
Pomo de mueble.

MATERIAL: EN 1.4301 / AISI 304

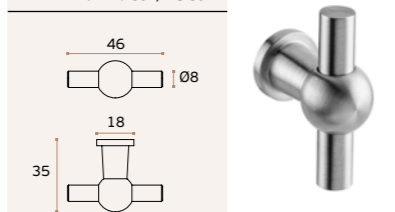

IN.22.152.16 STOUT

Puxador de móvel /
Furniture knob / Pomo de mueble.

.TB .TG .TCO .TCH

MATERIAL: EN 1.4301 / AISI 304

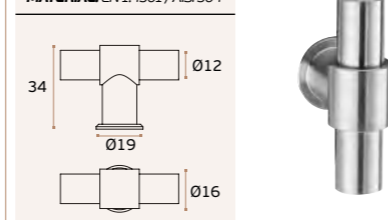

IN.22.152.14 STOUT

Puxador de móvel /
Furniture knob / Pomo de mueble.

.TB .TG .TCO .TCH

MATERIAL: EN 1.4301 / AISI 304

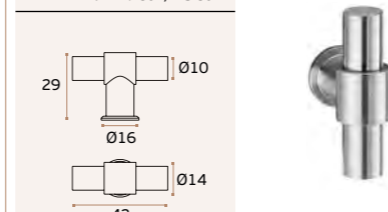

.P
Mirror
finish

.TB
PVD
Titanium
black

.TG
PVD
Titanium
gold

.TCO
PVD
Titanium
copper

.TCH
PVD
Titanium
chocolate

.P
Mirror
finish

.TB
PVD
Titanium
black

.TG
PVD
Titanium
gold

.TCO
PVD
Titanium
copper

.TCH
PVD
Titanium
chocolate

IN.22.500.

Puxador de móvel ou
para porta interior /
Furniture knob or door pull handle /
Pomo de mueble o de puerta interior.

BLACK
RAL 9005

other
colors
available
outras cores
disponíveis



MATERIAL: ALUMÍNIO / ALUMINIUM / ALUMINIO
ACABAMENTO / FINISH / ACABADO:
STANDARD: RAL 9005

OUTRAS CORES DISPONÍVEIS POR
PEDIDO / OTHER COLORS AVAILABLE
BY REQUEST / OTROS COLORES
DISPONIBLES POR SOLICITUD

REF.	DIMENSIONS
IN.22.500.150	150mm
IN.22.500.300	300mm
IN.22.500.500	500mm
IN.22.500.1250	1250mm
IN.22.500.2500	2500mm

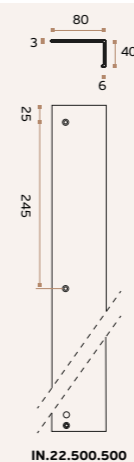

IN.22.500.500

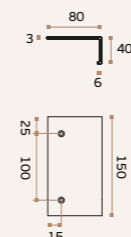

IN.22.500.150

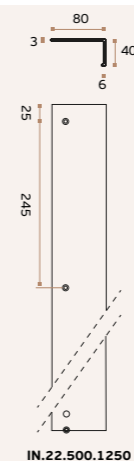

IN.22.500.1250

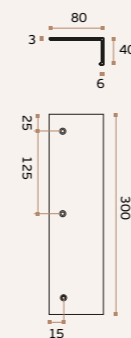

IN.22.500.300

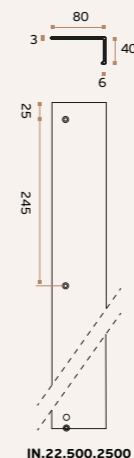

IN.22.500.2500

IN.22.117

Puxador de móvel /
Furniture knob /
Pomo de mueble.

MATERIAL: EN 1.4301 / AISI 304

ACABAMENTO / FINISH ACABADO: SATINADO / SATIN

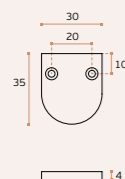

MV.22.010 TUBYK

Puxador de móvel /
Furniture knob /
Pomo de mueble.

MATERIAL: EN 1.4301 / AISI 304

ACABAMENTO / FINISH ACABADO: SATINADO / SATIN

DESIGN: MIGUEL VASCONCELOS

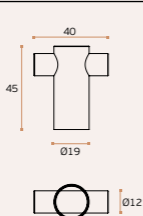

IN.22.185 LOFT

Puxador de móvel /
Furniture knob /
Pomo de mueble.

MATERIAL: EN 1.4301 / AISI 304

ACABAMENTO / FINISH ACABADO: SATINADO / SATIN



ASAS DE MÓVEL / FURNITURE HANDLES / TIRADORES DE MUEBLE.



NEW

IN.22.136.KN

Asa de móvel /
Furniture handle /
Tirador de mueble.

.P
Mirror
finish

.TB
PVD
Titanium
black

.TG
PVD
Titanium
gold

.TCO
PVD
Titanium
copper

.TCH
PVD
Titanium
chocolate



MATERIAL: EN 1.4301 / AISI 304

ACABAMENTO / FINISH / ACABADO:
STANDARD: SATINADO / SATIN / SATIN

OPTIONAL: PVD TITANIUM COATED

.TB / .TG / .TCO / .TCH

A	B
128	183
160	215
224	279

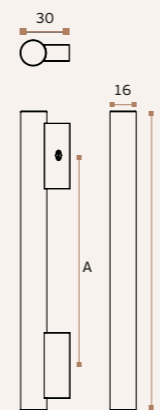

NEW

IN.22.153.16.KN

Asa de móvel /
Furniture handle /
Tirador de mueble.



MATERIAL: EN 1.4301 / AISI 304

ACABAMENTO / FINISH / ACABADO:
STANDARD: SATINADO / SATIN / SATIN

OPTIONAL: PVD TITANIUM COATED

.TB / .TG / .TCO / .TCH

A	B
128	176
160	208
224	272

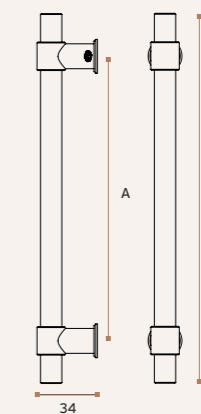

ASAS DE MÓVEL / FURNITURE HANDLES / TIRADORES DE MUEBLE.

IN.07.287.14

Asa de móvel /
Furniture handle /
Tirador de mueble.



MATERIAL: EN 1.4301 / AISI 304

ACABAMENTO / FINISH / ACABADO:
STANDARD: SATINADO / SATIN / SATIN

OPTIONAL: PVD TITANIUM COATED

.TB / .TG / .TCO / .TCH

A	B
250	264
300	314
600	614

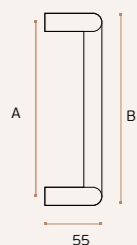

IN.07.287.14.A

Asa de móvel /
Furniture handle /
Tirador de mueble.

MATERIAL:
EN 1.4301 / AISI 304

ACABAMENTO / FINISH / ACABADO:
STANDARD: SATINADO / SATIN / SATIN

A	B
250	264
300	314
600	614

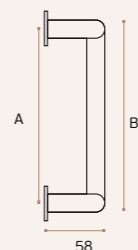

.P
Mirror
finish

.TB
PVD
Titanium
black

.TG
PVD
Titanium
gold

.TCO
PVD
Titanium
copper

.TCH
PVD
Titanium
chocolate



ASAS DE MÓVEL / FURNITURE HANDLES / TIRADORES DE MUEBLE.

IN.22.200.08.____ QUADRO

Asa de móvel /
Furniture handle /
Tirador de mueble.

MATERIAL: EN 1.4301 / AISI 304

ACABAMENTO / FINISH / ACABADO:
STANDARD: SATINADO / SATIN / SATIN

C.C.	L	H
96	104	35
128	136	35
160	168	35
192	200	35
224	232	35

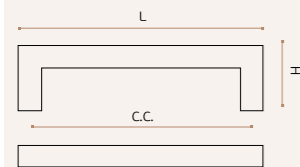

∅8x8



IN.22.200.10.____ QUADRO

Asa de móvel /
Furniture handle /
Tirador de mueble.

MATERIAL: EN 1.4301 / AISI 304

ACABAMENTO / FINISH / ACABADO:
STANDARD: SATINADO / SATIN / SATIN

C.C.	L	H
32	42	35
96	106	35
128	138	35
160	170	35
224	234	35
320	330	35

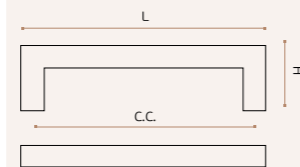

∅10x10



IN.22.200.12.____ QUADRO

Asa de móvel /
Furniture handle /
Tirador de mueble.

MATERIAL: EN 1.4301 / AISI 304

ACABAMENTO / FINISH / ACABADO:
STANDARD: SATINADO / SATIN / SATIN

C.C.	L	H
128	140	35
160	172	35
224	236	35
320	332	35
480	492	35
704	716	35

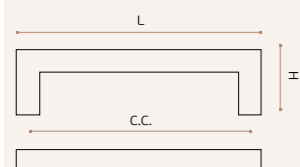

∅12x12



IN.22.200.16.____ QUADRO

Asa de móvel /
Furniture handle /
Tirador de mueble.

MATERIAL: EN 1.4301 / AISI 304

ACABAMENTO / FINISH / ACABADO:
STANDARD: SATINADO / SATIN / SATIN

C.C.	L	H
224	240	40
384	400	40
480	496	40
704	720	40

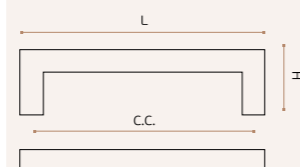

∅16x16



ASAS DE MÓVEL / FURNITURE HANDLES / TIRADORES DE MUEBLE.

IN.22.204.10.____

Asa de móvel /
Furniture handle /
Tirador de mueble.

MATERIAL: EN 1.4301 / AISI 304

ACABAMENTO / FINISH / ACABADO:
STANDARD: SATINADO / SATIN / SATIN

C.C.	L
96	106
128	138
224	234
320	330



Ø10



IN.22.204.16.____

Asa de móvel /
Furniture handle /
Tirador de mueble.

MATERIAL: EN 1.4301 / AISI 304

ACABAMENTO / FINISH / ACABADO:
STANDARD: SATINADO / SATIN / SATIN

C.C.	L
224	240
320	336
384	400
448	464



Ø16



IN.22.202.08.____

Asa de móvel /
Furniture handle /
Tirador de mueble.

MATERIAL: EN 1.4301 / AISI 304

ACABAMENTO / FINISH / ACABADO:
STANDARD: SATINADO / SATIN / SATIN

C.C.	L
64	72
96	104
128	136
160	168
224	232

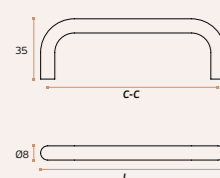

Ø08



IN.22.202.10.____

Asa de móvel /
Furniture handle /
Tirador de mueble.

MATERIAL: EN 1.4301 / AISI 304

ACABAMENTO / FINISH / ACABADO:
STANDARD: SATINADO / SATIN / SATIN

C.C.	L
96	106
128	138
224	234
320	330
512	522

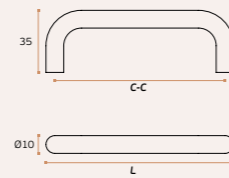

Ø10



IN.22.225.18.____ TRAIN

Asa de móvel /
Furniture handle /
Tirador de mueble.

MATERIAL: EN 1.4301 / AISI 304

ACABAMENTO / FINISH / ACABADO:
STANDARD: SATINADO / SATIN / SATIN

C.C.	L	H
96	142	8
128	174	8
160	206	8

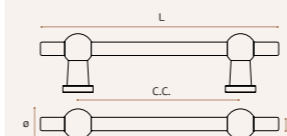

Ø18



IN.22.225.18.TB
pvd titanium black



IN.22.225.18.TG
pvd titanium gold



IN.22.225.18.TCO
pvd titanium copper



IN.22.225.18.TCH
pvd titanium chocolate

ASAS DE MÓVEL / FURNITURE HANDLES / TIRADORES DE MUEBLE.

IN.22.209.10. ____

 Asa de móvel / Furniture handle /
 Tirador de mueble.

MATERIAL: EN 1.4301 / AISI 304

 ACABAMENTO / FINISH / ACABADO:
 STANDARD: SATINADO / SATIN / SATIN

C.C.	L	H
96	136	31
128	168	31
160	200	31
192	232	31
224	264	31
288	328	31
320	360	31
352	392	31
384	424	31
448	488	31
480	520	31
544	584	31
640	680	31
704	744	31
736	776	31
832	872	31
896	936	31
960	1000	31
1184	1224	31
1376	1416	31

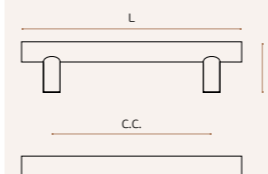

Ø10

IN.22.209.12. ____

 Asa de móvel / Furniture handle /
 Tirador de mueble.

MATERIAL: EN 1.4301 / AISI 304

 ACABAMENTO / FINISH / ACABADO:
 STANDARD: SATINADO / SATIN / SATIN

C.C.	L	H
96	156	31
128	188	31
160	220	31
192	252	31
224	284	31
288	348	31
320	380	31
352	412	31
384	444	31
448	508	31
480	540	31
544	604	31
640	700	31
704	744	31
736	796	31
832	892	31
896	956	31
960	1020	31
1184	1244	31
1376	1436	31

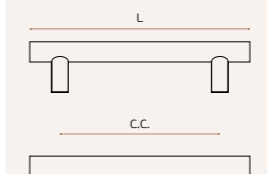

Ø12

ASAS DE MÓVEL /
FURNITURE HANDLES / TIRADORES DE MUEBLE.**IN.16.317**

Concha com puxador retráctil /
Flush handle with with retractable handle /
Cazoleta con manilla retráctil.

MATERIAL: EN 1.4301 / AISI 304

ACABAMENTO / FINISH / ACABADO:
STANDARD: SATINADO / SATIN / SATIN

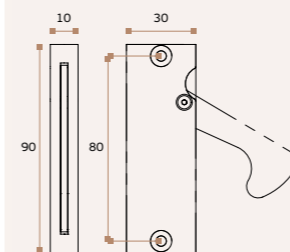
**IN.16.317.R**

Concha com puxador retráctil /
Flush handle with with retractable handle /
Cazoleta con manilla retráctil.

MATERIAL: EN 1.4301 / AISI 304

ACABAMENTO / FINISH / ACABADO:
STANDARD: SATINADO / SATIN / SATIN

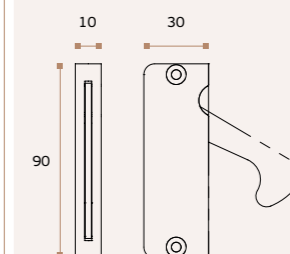
**IN.16.104**

Concha de embutir /
Concealed flush handle /
Cazoleta de embutir.

MATERIAL: EN 1.4301 / AISI 304

ACABAMENTO / FINISH / ACABADO:
SATINADO / SATIN / SATIN

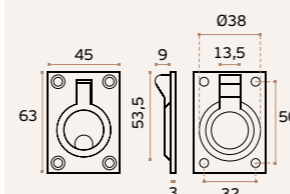
**IN.16.105**

Concha de embutir /
Concealed flush handle /
Cazoleta de embutir.

MATERIAL: EN 1.4301 / AISI 304

ACABAMENTO / FINISH / ACABADO:
SATINADO / SATIN / SATIN

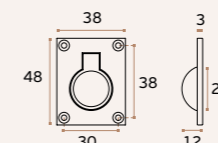
**IN.16.103**

Concha de embutir /
Concealed flush handle /
Cazoleta de embutir.

MATERIAL: EN 1.4301 / AISI 304

ACABAMENTO / FINISH / ACABADO:
SATINADO / SATIN / SATIN

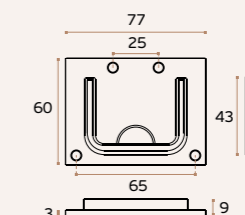
**IN.16.106**

Concha de embutir /
Concealed flush handle /
Cazoleta de embutir.

MATERIAL: EN 1.4301 / AISI 304

ACABAMENTO / FINISH / ACABADO:
SATINADO / SATIN / SATIN

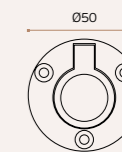

CONCHAS PLANAR / PLANAR FLUSH HANDLES / CAZOLETAS PLANAR



NEW

IN.16.020.200
Concha de embutir /
Concealed flush handle /
Cazoleta de embutir.

.TB .TG .TCO .TCH

MATERIAL: EN 1.4301 / AISI 304

ACABAMENTO / FINISH / ACABADO:
STANDARD: SATINADO / SATIN / SATIN

OPTIONAL: PVD TITANIUM COATED

.TB / .TG / .TCO / .TCH

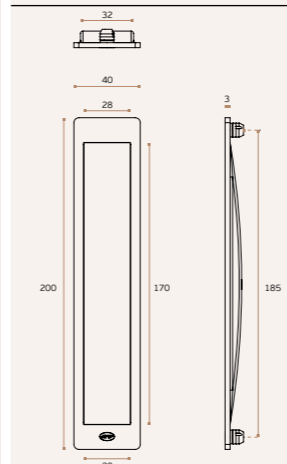

NEW

IN.16.020.200.PZ
Concha para cilindro europeu /
Flush handle for european cylinder /
Cazoleta par cilindro europeu

.TB .TG .TCO .TCH

MATERIAL: EN 1.4301 / AISI 304

ACABAMENTO / FINISH / ACABADO:
STANDARD: SATINADO / SATIN / SATIN

OPTIONAL: PVD TITANIUM COATED

.TB / .TG / .TCO / .TCH

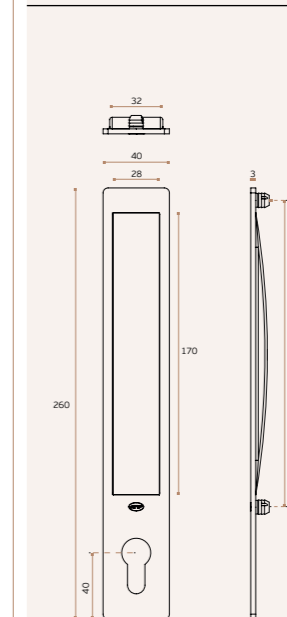

NEW

IN.16.020.120
Concha de embutir /
Concealed flush handle /
Cazoleta de embutir.

.TB .TG .TCO .TCH

MATERIAL: EN 1.4301 / AISI 304

ACABAMENTO / FINISH / ACABADO:
STANDARD: SATINADO / SATIN / SATIN

OPTIONAL: PVD TITANIUM COATED

.TB / .TG / .TCO / .TCH

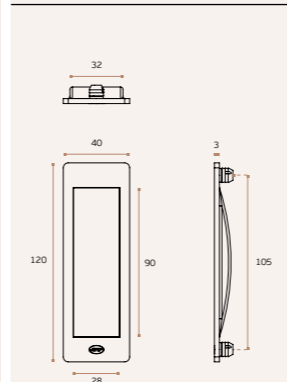

CONCHAS / FLUSH HANDLES / CAZOLETAS.



.P
Mirror
finish

.TB
PVD
Titanium
black

.TG
PVD
Titanium
gold

.TCO
PVD
Titanium
copper

.TCH
PVD
Titanium
chocolate

NEW

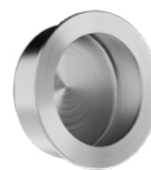

IN.16.241.35
Concha de embutir / Concealed flush handle / Cazoleta de embutir.

.TB .TG .TCO .TCH

MATERIAL: EN 1.4301 / AISI 304

ACABAMENTO / FINISH / ACABADO STANDARD: SATINADO / SATIN / SATIN

OPTIONAL: PVD TITANIUM COATED

.TB / .TG / .TCO / .TCH

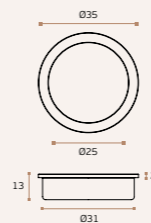

NEW



IN.16.241.50
Concha de embutir / Concealed flush handle / Cazoleta de embutir.

.TB .TG .TCO .TCH

MATERIAL: EN 1.4301 / AISI 304

ACABAMENTO / FINISH / ACABADO STANDARD: SATINADO / SATIN / SATIN

OPTIONAL: PVD TITANIUM COATED

.TB / .TG / .TCO / .TCH

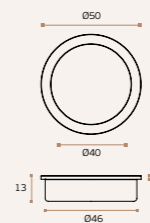

NEW



IN.16.241.70
Concha de embutir / Concealed flush handle / Cazoleta de embutir.

.TB .TG .TCO .TCH

MATERIAL: EN 1.4301 / AISI 304

ACABAMENTO / FINISH / ACABADO STANDARD: SATINADO / SATIN / SATIN

OPTIONAL: PVD TITANIUM COATED

.TB / .TG / .TCO / .TCH

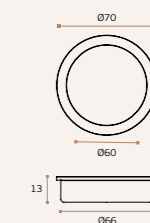

NEW



IN.16.243.35
Concha de embutir / Concealed flush handle / Cazoleta de embutir.

.TB .TG .TCO .TCH

MATERIAL: EN 1.4301 / AISI 304

ACABAMENTO / FINISH / ACABADO STANDARD: SATINADO / SATIN / SATIN

OPTIONAL: PVD TITANIUM COATED

.TB / .TG / .TCO / .TCH

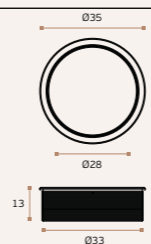

NEW



IN.16.243.50
Concha de embutir / Concealed flush handle / Cazoleta de embutir.

.TB .TG .TCO .TCH

MATERIAL: EN 1.4301 / AISI 304

ACABAMENTO / FINISH / ACABADO STANDARD: SATINADO / SATIN / SATIN

OPTIONAL: PVD TITANIUM COATED

.TB / .TG / .TCO / .TCH

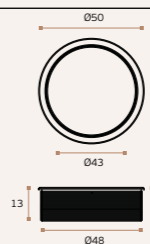

NEW



IN.16.243.70
Concha de embutir / Concealed flush handle / Cazoleta de embutir.

.TB .TG .TCO .TCH

MATERIAL: EN 1.4301 / AISI 304

ACABAMENTO / FINISH / ACABADO STANDARD: SATINADO / SATIN / SATIN

OPTIONAL: PVD TITANIUM COATED

.TB / .TG / .TCO / .TCH

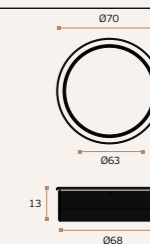

CONCHAS / FLUSH HANDLES / CAZOLETAS.

NEW



IN.16.242.35
Concha de embutir / Concealed flush handle / Cazoleta de embutir.

.TB .TG .TCO .TCH

MATERIAL: EN 1.4301 / AISI 304

ACABAMENTO / FINISH / ACABADO STANDARD: SATINADO / SATIN / SATIN

OPTIONAL: PVD TITANIUM COATED

.TB / .TG / .TCO / .TCH

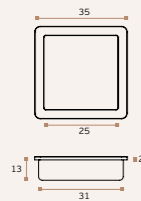

NEW



IN.16.242.50
Concha de embutir / Concealed flush handle / Cazoleta de embutir.

.TB .TG .TCO .TCH

MATERIAL: EN 1.4301 / AISI 304

ACABAMENTO / FINISH / ACABADO STANDARD: SATINADO / SATIN / SATIN

OPTIONAL: PVD TITANIUM COATED

.TB / .TG / .TCO / .TCH

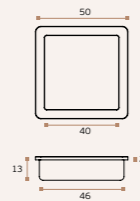

NEW



IN.16.242.70
Concha de embutir / Concealed flush handle / Cazoleta de embutir.

.TB .TG .TCO .TCH

MATERIAL: EN 1.4301 / AISI 304

ACABAMENTO / FINISH / ACABADO STANDARD: SATINADO / SATIN / SATIN

OPTIONAL: PVD TITANIUM COATED

.TB / .TG / .TCO / .TCH

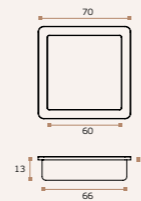

.P
Mirror finish

.TB
PVD Titanium black

.TG
PVD Titanium gold

.TCO
PVD Titanium copper

.TCH
PVD Titanium chocolate

NEW



IN.16.244.35
Concha de embutir / Concealed flush handle / Cazoleta de embutir.

.TB .TG .TCO .TCH

MATERIAL: EN 1.4301 / AISI 304

ACABAMENTO / FINISH / ACABADO STANDARD: SATINADO / SATIN / SATIN

OPTIONAL: PVD TITANIUM COATED

.TB / .TG / .TCO / .TCH

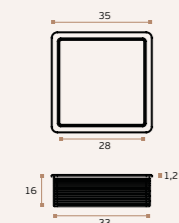

NEW



IN.16.244.50
Concha de embutir / Concealed flush handle / Cazoleta de embutir.

.TB .TG .TCO .TCH

MATERIAL: EN 1.4301 / AISI 304

ACABAMENTO / FINISH / ACABADO STANDARD: SATINADO / SATIN / SATIN

OPTIONAL: PVD TITANIUM COATED

.TB / .TG / .TCO / .TCH

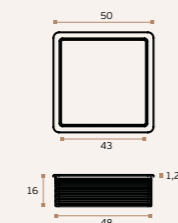

NEW



IN.16.244.70
Concha de embutir / Concealed flush handle / Cazoleta de embutir.

.TB .TG .TCO .TCH

MATERIAL: EN 1.4301 / AISI 304

ACABAMENTO / FINISH / ACABADO STANDARD: SATINADO / SATIN / SATIN

OPTIONAL: PVD TITANIUM COATED

.TB / .TG / .TCO / .TCH

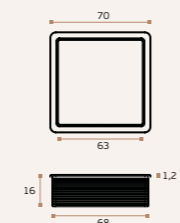

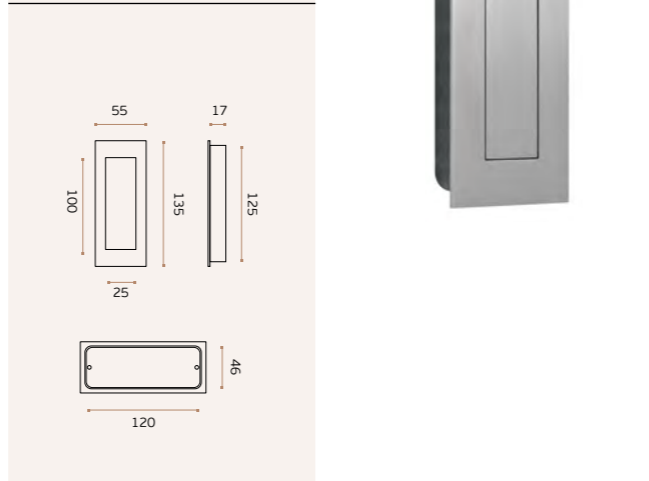
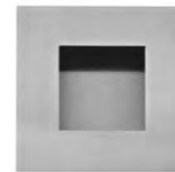
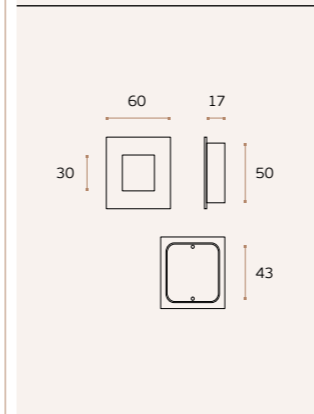
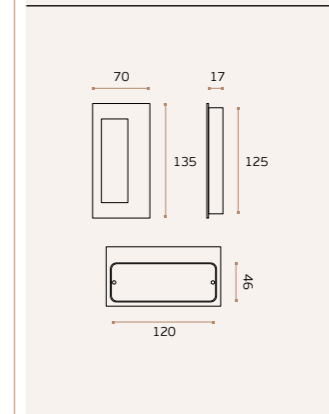
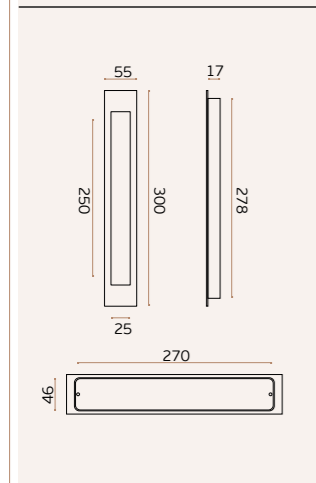
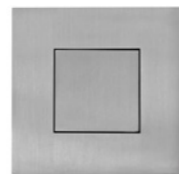
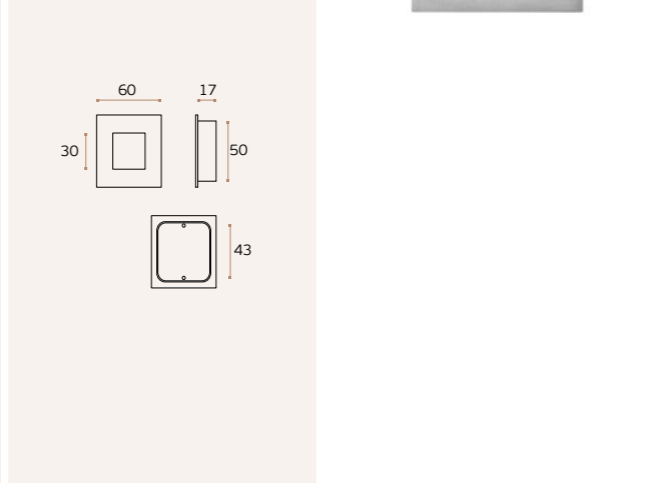
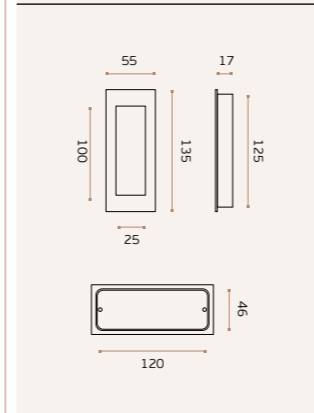
**CONCHAS /
FLUSH HANDLES / CAZOLETAS.****IN.16.400****Concha com placa de mola /
Flush handle with spring cover /
Cazoleta con cubierta de muelle.****MATERIAL:** EN 1.4301 / AISI 304**ACABAMENTO / FINISH / ACABADO:**
STANDARD: SATINADO / SATIN / SATIN**IN.16.402****Concha com placa de mola /
Flush handle with spring cover /
Cazoleta con cubierta de muelle.****MATERIAL:** EN 1.4301 / AISI 304**ACABAMENTO / FINISH / ACABADO:**
STANDARD: SATINADO / SATIN / SATIN**OPTIONAL:** POLIDO/POLISHED/PULIDO**.P****.P**
Mirror
finish**.TB**
PVD
Titanium
black**.TG**
PVD
Titanium
gold**.TCO**
PVD
Titanium
copper**.TCH**
PVD
Titanium
chocolate**.P**
Mirror
finish**.TB**
PVD
Titanium
black**.TG**
PVD
Titanium
gold**.TCO**
PVD
Titanium
copper**.TCH**
PVD
Titanium
chocolate**IN.16.414****Concha de embutir /
Concealed flush handle /
Cazoleta de embutir.****.P .TB .TG .TCO .TCH****MATERIAL:** EN 1.4301 / AISI 304**ACABAMENTO / FINISH / ACABADO:**
STANDARD: SATINADO / SATIN / SATIN**OPTIONAL:** PVD TITANIUM COATED**.TB / .TG / .TCO / .TCH****OPTIONAL:** POLIDO/POLISHED/PULIDO**.P****IN.16.410****Concha de embutir /
Concealed flush handle /
Cazoleta de embutir.****.P .TB .TG .TCO .TCH****MATERIAL:** EN 1.4301 / AISI 304**ACABAMENTO / FINISH / ACABADO:**
STANDARD: SATINADO / SATIN / SATIN**OPTIONAL:** PVD TITANIUM COATED**.TB / .TG / .TCO / .TCH****OPTIONAL:** POLIDO/POLISHED/PULIDO**.P****IN.16.406****Concha com placa de mola /
Flush handle with spring cover /
Cazoleta con cubierta de muelle.****.P****MATERIAL:** EN 1.4301 / AISI 304**ACABAMENTO / FINISH / ACABADO:**
STANDARD: SATINADO / SATIN / SATIN**OPTIONAL:** POLIDO/POLISHED/PULIDO**.P****IN.16.404****Concha com placa de mola /
Flush handle with spring cover /
Cazoleta con cubierta de muelle.****MATERIAL:** EN 1.4301 / AISI 304**ACABAMENTO / FINISH / ACABADO:**
STANDARD: SATINADO / SATIN / SATIN**OPTIONAL:** POLIDO/POLISHED/PULIDO**.P****IN.16.412****Concha de embutir /
Concealed flush handle /
Cazoleta de embutir.****.P .TB .TG .TCO .TCH****MATERIAL:** EN 1.4301 / AISI 304**ACABAMENTO / FINISH / ACABADO:**
STANDARD: SATINADO / SATIN / SATIN**OPTIONAL:** PVD TITANIUM COATED**.TB / .TG / .TCO / .TCH****OPTIONAL:** POLIDO/POLISHED/PULIDO**.P****IN.16.416****Concha de embutir /
Concealed flush handle /
Cazoleta de embutir.****.P .TB .TG .TCO .TCH****MATERIAL:** EN 1.4301 / AISI 304**ACABAMENTO / FINISH / ACABADO:**
STANDARD: SATINADO / SATIN / SATIN**OPTIONAL:** PVD TITANIUM COATED**.TB / .TG / .TCO / .TCH****OPTIONAL:** POLIDO/POLISHED/PULIDO**.P**