



# Galbusera

*Ferro battuto d'arte - Traditional Ironwork*



**CATALOGO FERRAMENTA CLASSICA 2015**  
**ARCHITECTURAL HARDWARE CATALOGUE 2015**

**DAL 1925 - SINCE 1925**

*Made in Italy*







# Galbusera Giancarlo & Giorgio snc

Premiata fabbrica ferro battuto d'arte - ferramenta artistica

## **SEDE – HEAD OFFICE**

23868 VALMADRERA (LC) – ITALY

VIA G. VERDI 10

T: +39 (0)341 58.12.84 F: +39 (0)341 20.10.68

E: MAIL@GALBUSERAGG.IT

W: WWW.GALBUSERAGG.IT

WWW.ANTIKBESCHLAEGE.BIZ

PARTITA IVA E CODICE FISCALE: IT 00205480130

## **PRODUZIONE-PRODUCTION**

23868 VALMADRERA (LC) VIA G. VERDI 10

23862 CIVATE (LC) VIA SAN PAOLO 1

**FONDATA NEL 1925  
SINCE 1925**



Premio Qualità  
*Quality Award*



Albo d'oro del Lavoro  
*Business Gold Award*



## Galbusera produce:

### Ferro Battuto D'Arte

Servizi ed attrezzi per camino, alari, parascintille, portalegna, catena per camino e griglie per camino. Spiedi girarrosti per esterni ed interni. Campane per ingressi, banderuole segnamento, cassette per lettere a muro, a piantana. Portabottiglie, cavatappi, portariviste, portachiavi, portacenere, oggetti decorativi, candelieri, articoli da regalo. Specchiere e consolle, attaccapanni, portabiti, portaombrelli, fioriere. Illuminazione: lampadari, appliques, lampade, abatjourns, lampioni, lanterne a braccio e a catena. Riloghe e scorritende.

### Ferramenta artistica in ferro forgiato e battuto

Maniglie per porte, martelline e cremonesi per finestre, cerniere, paumelles per porte e finestre, maniglioni, battenti, pomoli, chiavistelli, catenacci, spranghe, bandelle, squadre, spagnolette, fermapersiane, chiodi, borchie copridado, teste per chiavi, coprinterruttori, targhe e buche per lettere con campanello, mensole piane a gancio, ganci universali e appendiabiti, catene. Manigliette, cerniere, pomoli, pendenti, bocchette, decorazioni per guarnizioni mobili. Riloghe e accessori scorritenda, piastre copriavvolgibili, reggicordoni. Pannelli, elementi, particolari, foglie, aste, barre in ferro grezzo per lavorazioni artistiche.

### Arredi da giardino per esterni in ferro battuto

Fioriere, portafiori, lanterne e lampade a stelo, a muro e a catena, in stile "Liberty floreale".



## The Company Galbusera manufactures:

### Artistic wrought-iron

*Fireplace sets and accessories: andirons, fire screens, wood holders, fireplace chain. Roasting jacks for home and garden. Doorbells, weathervanes, wall - and floor - letter boxes. Bottle-racks, magazine-racks, corkscrews, key boxes, ashtrays, ornamental items, candlesticks, giftware. Mirrors and consoles, clothes stands and clothes hooks, umbrella stands, flower boxes. Lighting fixtures: chandeliers, sconces, lamps, abatjourns, wall lanterns, chain hung lanterns. Curtain rails and rods.*

### Fine forged and wrought-iron hardware

*Door and window handles and cremona bolts, hinges for doors and windows, door knockers, knobs, bar latches, barrel bolts, bars, strap hinges, flat corner irons, espagnolettes, shutter stops and holders, nails, escutcheon plates, style key heads, switch plates, letter plates and boxes, doorbells, hook brackets, standard brackets, hat & coat hooks and chains. Handles, hinges, knobs, pendant pulls, plates, furniture decorations. Curtain rails and accessories, roller shutter covers, rope brackets. Panels, elements, leaves, rods, iron bars for fine forged and wrought iron workings.*

### Wrought-iron furniture and fittings for the garden

*Flower boxes, flower stands, floor lamps, wall lamps, chain hung lamps and lanterns in "Liberty style"*



Premio  
Qualità Italia



Premio Albo d'Oro  
del Lavoro

# INDICE - INDEX:

## **Maniglie per porte e finestre / Door and window handles collections :**

Collezione "Roma" / "Rome" collection .....	Pagina / Page 4-5
Collezione "Londra" / "London" collection .....	Pagina / Page 6-7
Collezione "Oslo" / "Oslo" collection .....	Pagina / Page 8-9
Collezione "Berlino" / "Berlin" collection .....	Pagina / Page 10-11
Collezione "Madrid" / "Madrid" collection .....	Pagina / Page 12-13
Collezione "Lisbona" / "Lisbon" collection .....	Pagina / Page 14-15
Collezione "Berna" / "Bern" collection .....	Pagina / Page 16-17
Collezione "Mosca" / "Moscow" collection .....	Pagina / Page 18-19
Collezione "Budapest" / "Budapest" collection .....	Pagina / Page 20-21
Collezione "Tallin" / "Tallin" collection .....	Pagina / Page 22-23
Collezione "Monaco" / "Munich" collection .....	Pagina / Page 24
Collezione "Brema" / "Bremen" collection .....	Pagina / Page 25
Collezione "Salisburgo" / "Salzburg" collection .....	Pagina / Page 26
Collezione "Stoccolma" / "Stockholm" collection .....	Pagina / Page 27
Collezione "Helsinki" / "Helsinki" collection .....	Pagina / Page 28
Collezione "Milano" / "Milan" collection .....	Pagina / Page 29
Collezione "Parigi" / "Paris" collection .....	Pagina / Page 30-31
Collezione "Atene" / "Athens" collection .....	Pagina / Page 32-33
Collezione "Vienna" / "Wien" collection .....	Pagina / Page 34-35
Collezione "Praga" / "Prague" collection .....	Pagina / Page 36-37
Collezione "Copenaghen" / "Copenhagen" collection .....	Pagina / Page 38-39
Collezione "Amsterdam" / "Amsterdam" collection .....	Pagina / Page 40
Collezione "Dublino" / "Dublin" collection .....	Pagina / Page 41
Collezione "Stile antico" / "Antique style" collection .....	Pagina / Page 42
Collezione "Provenza" / "Provence" collection .....	Pagina / Page 44

## **Ferramenta per porte e finestre / Door and window hardware**

Battenti / Door knockers .....	Pagina / Page 43
Placche per lettere / Letter plates .....	Pagina / Page 43
Pomoli / Door knobs .....	Pagina / Page 44
Maniglioni / Door pull handles .....	Pagina / Page 45-48
Maniglioni per alzanti scorrevoli / Lift and slide handles .....	Pagina / Page 49
Maniglie per porte scorrevoli / Sliding door pulls .....	Pagina / Page 49
Maniglie ad anello / Ring turn handles .....	Pagina / Page 49
Cremonesi per aste esterne / Cremonese bolts for external rods .....	Pagina / Page 50-51
Dry keep con serratura / Lockable tilt and turn handle .....	Pagina / Page 52
Serrature da applicare / Rim locks .....	Pagina / Page 52-53
Catenacci / Bolts .....	Pagina / Page 54
Saltarelli e chiavistelli / Thumbblatches and latches .....	Pagina / Page 55
Nottolini WC / Privacy snibs .....	Pagina / Page 56
Rosette strette per maniglie / Narrow escutcheons .....	Pagina / Page 56
Cerniere / Hinges .....	Pagina / Page 57
Fasce per porte / Door kick plates .....	Pagina / Page 58
Supporti per corrimano / Holder for handrail .....	Pagina / Page 58
Copricerniere / Hinge covers .....	Pagina / Page 58
Appendiabiti e grucce / Coat hooks and hangers .....	Pagina / Page 59
Numeri civici / Civic numbers .....	Pagina / Page 60
Accessori Vari / Small accessories .....	Pagina / Page 60
Placche strette per maniglie / Narrow handle backplates .....	Pagina / Page 61

## **Maniglie di sicurezza / Security door handles**

Rosette e bocchette di sicurezza / Security rosettes .....	Pagina / Page 61
Maniglie di sicurezza classiche / Classic security sets .....	Pagina / Page 62
Maniglie di sicurezza rustiche / Rustic security sets .....	Pagina / Page 63
Maniglie di sicurezza su rosetta / Security sets with rosettes .....	Pagina / Page 64
Maniglie di sicurezza con placca Hardox® / Security door handles Hardox® backplate .....	Pagina / Page 65

## **Ferramenta per mobili / Cabinet hardware**

Maniglie per mobili / Furniture handles .....	Pagina / Page 66
Accessori per mobili / Furniture accessories .....	Pagina / Page 67
Pomoli porcellana "Bavaria" / Furniture knobs "Bavaria" porcelain .....	Pagina / Page 68

<b>Pannelli espositori / Advertising display boards</b> .....	Pagina / Page 69
---	------------------

<b>Informazioni sui nostri prodotti / Product information</b> .....	Pagina / Page 70-71
---	---------------------



Collezione **“Roma”**

**“Rome”** Collection

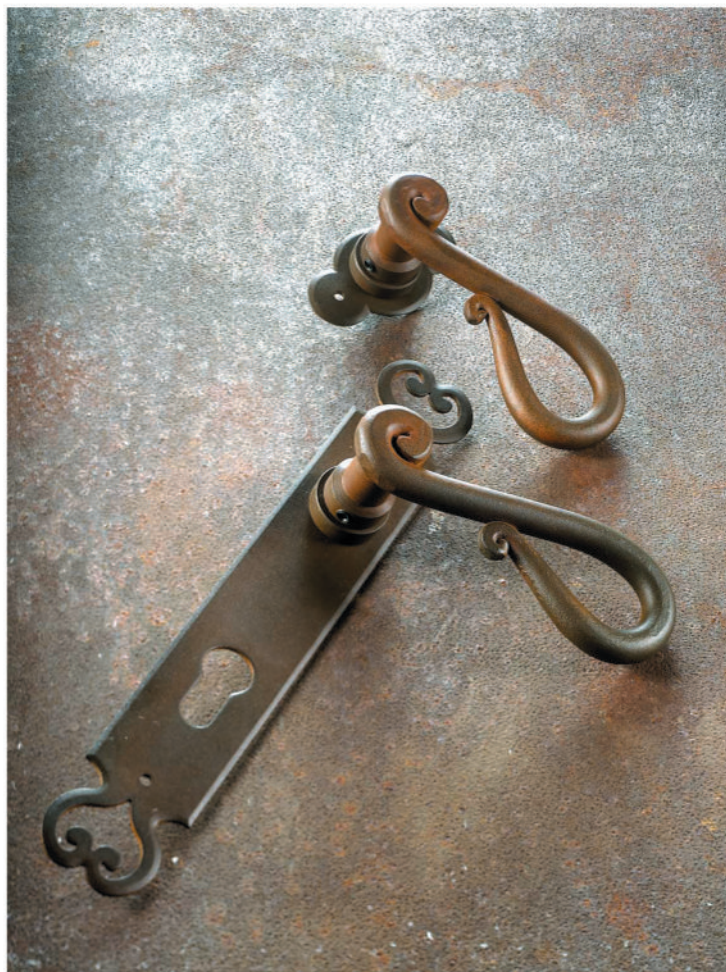

*Antichizzato ruggine - Antique rust*



Art. 2203/319



**Cremonese MP per aste esterne**  
**Cremonese bolt for external rod**

Art. 2203/319

Impugnatura - 115 mm  
Handle - 115 mm

Placca a scatola - 125x32 mm  
Raised backplate - 125x32 mm

**Martellina - Cremonese**  
**Window handle - Cremonese bolt**

Art. 2204

Impugnatura - 115 mm  
Handle - 115 mm

Placca a scatola - 135x35x11 mm  
Raised backplate - 135x35x11 mm



Art. 2204



Art. 2200



Art. 2201



Art. 2205 dx



Art. 2203



Art. 2202



**Maniglia per porta**  
**Door handle**

**Art. 2200**

Impugnatura - 125 mm  
Handle - 125 mm

Placca - 260x40x2 mm  
Backplate - 260x40x2 mm



**Maniglia per porta**  
**Door handle**

**Art. 2201**

Impugnatura - 125 mm  
Handle - 125 mm

Rosetta - Bocchetta - 72x40x2 mm  
Rosette - Escutcheon plate - 72x40x2 mm



**Martellina D K - Dry keep**

**Art. 2205**

Impugnatura - 125 mm  
Handle - 125 mm

Scatola - 65x32x12 mm  
Raised backplate - 65x32x12 mm



**Martellina - Cremonese**  
**Window handle - Cremonese bolt**

**Art. 2203**

Impugnatura - 115 mm  
Handle - 115 mm

Placca - 200x40x2 mm  
Backplate - 200x40x2 mm



**Martellina con rosetta**  
**Window handle with rosette**

**Art. 2202**

Impugnatura - 115 mm  
Handle - 115 mm

Rosetta - 72x40x2 mm  
Rosette - 72x40x2 mm



Collezione

“Londra”

“London” Collection



*Nero antico - Antique black*



Art. 2304



**Martellina**  
**Window handle**

**Art. 2304**

Impugnatura - 110 mm  
Handle - 110 mm

Placca - 118x50x2 mm  
Backplate - 118x50x2 mm

**Martellina - Cremonese**  
**Window handle - Cremonese bolt**

**Art. 2305**

Impugnatura - 110 mm  
Handle - 110 mm

Placca a scatola - 135x35x11 mm  
Raised backplate - 135x35x11 mm



Art. 2305





Art. 2300



Art. 2301

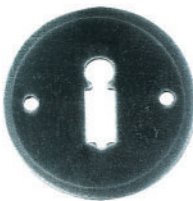

Art. 2302

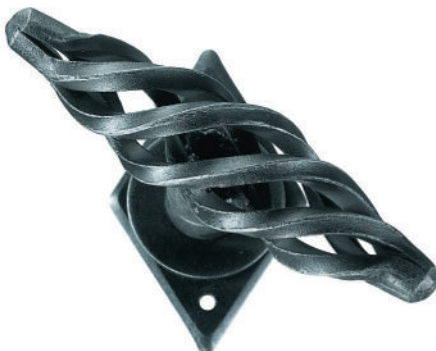

Art. 2303



Art. 2306



**Maniglia per porta**  
**Door handle**

**Art. 2300**

Impugnatura - 125 mm  
 Handle - 125 mm

Placca - 245x45x2 mm  
 Backplate - 245x45x2 mm



**Maniglia per porta**  
**Door handle**

**Art. 2301**

Impugnatura - 125 mm  
 Handle - 125 mm

Rosetta - Bocchetta - 70x45x2 mm  
 Rosette - Escutcheon plate - 70x45x2 mm



**Maniglia per porta**  
**Door handle**

**Art. 2302**

Impugnatura - 125 mm  
 Handle - 125 mm

Rosetta - Bocchetta - Ø50x2 mm  
 Rosette - Escutcheon plate - Ø50x2 mm



**Martellina con rosetta**  
**Window handle with rosette**

**Art. 2303**

Impugnatura - 110 mm  
 Handle - 110 mm

Rosetta - 70x45x2 mm  
 Rosette - 70x45x2 mm



**Martellina D K - Dry keep**

**Art. 2306**

Impugnatura - 125 mm  
 Handle - 125 mm

Scatola - 65x32x12 mm  
 Raised backplate - 65x32x12 mm



# Collezione "Oslo"

## "Oslo" Collection



*Nero bronzato - Bronze black*



Art. 2403



### Martellina Window handle

Art. 2403

Impugnatura - 111 mm  
Handle - 111 mm

Placca - 140x40x2 mm  
Backplate - 140x40x2 mm

### Martellina - Cremonese Window handle - Cremonese bolt

Art. 2404

Impugnatura - 111 mm  
Handle - 111 mm

Placca a scatola - 135x35x11 mm  
Raised backplate - 135x35x11 mm



Art. 2404

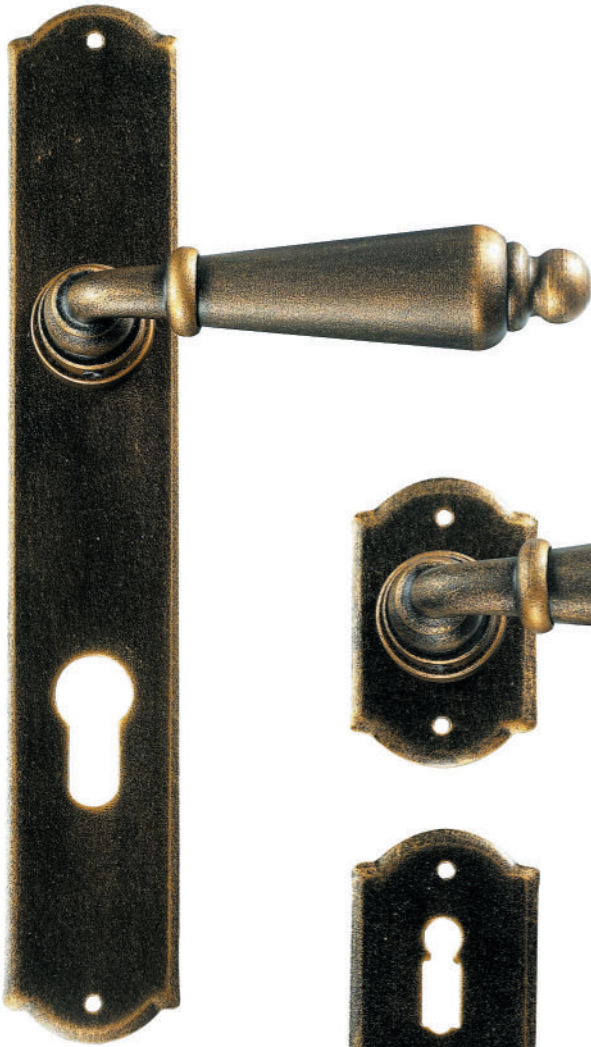

⇒ Art. 2400

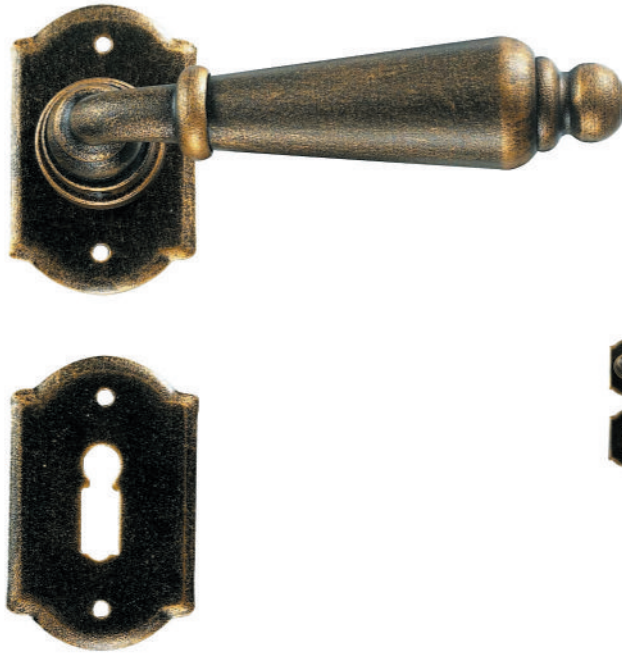

⇒ Art. 2401



**Maniglia per porta**  
**Door handle**

**Art. 2400**

Impugnatura - 130 mm  
 Handle - 130 mm

Placca - 240x40x2 mm  
 Backplate - 240x40x2 mm

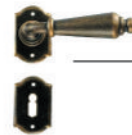

**Maniglia per porta**  
**Door handle**

**Art. 2401**

Impugnatura - 130 mm  
 Handle - 130 mm

Rosetta - Bocchetta - 64x40x2 mm  
 Rosette - Escutcheon plate - 64x40x2 mm

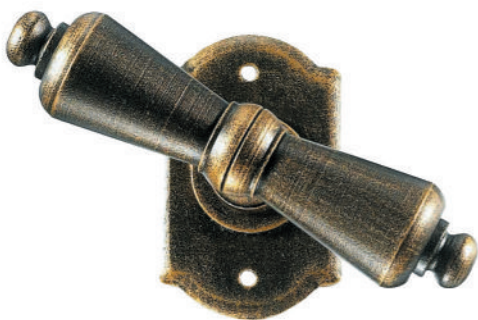

⇒ Art. 2402



⇒ Art. 2405



**Martellina D K - Dry keep**

**Art. 2405**

Impugnatura - 130 mm  
 Handle - 130 mm

Scatola - 65x32x12 mm  
 Raised backplate - 65x32x12 mm



**Martellina con rosetta**  
**Window handle with rosette**

**Art. 2402**

Impugnatura - 111 mm  
 Handle - 111 mm

Rosetta - 64x40x2 mm  
 Rosette - 64x40x2 mm





Collezione

“Berlino”

“Berlin” Collection

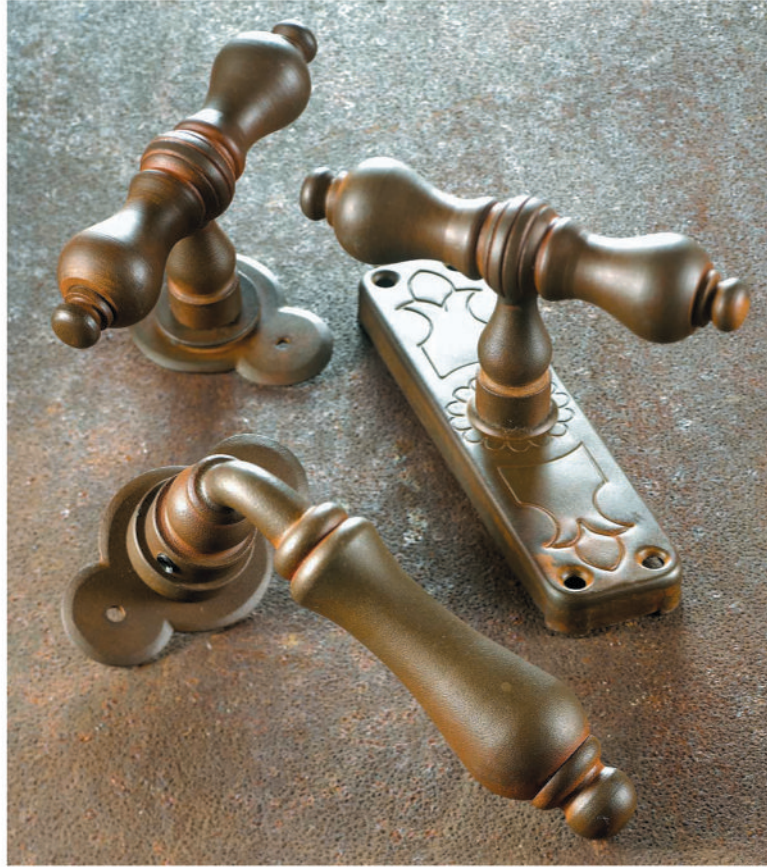

Antichizzato ruggine - *Antique rust*



Art. 2503



Martellina  
Window handle

Art. 2503

Impugnatura - 112 mm  
Handle - 112 mm

Placca - 200x40x2 mm  
Backplate - 200x40x2 mm

Martellina - Cremonese  
Window handle - Cremonese bolt

Art. 2504

Impugnatura - 112 mm  
Handle - 112 mm

Placca a scatola - 135x35x11 mm  
Raised backplate - 135x35x11 mm



Art. 2504



Art. 2500



Art. 2501



Art. 2502



Art. 2505



**Maniglia per porta**  
**Door handle**

**Art. 2500**

Impugnatura - 125 mm  
Handle - 125 mm

Placca - 250x40x2 mm  
Backplate - 250x40x2 mm



**Maniglia per porta**  
**Door handle**

**Art. 2501**

Impugnatura - 125 mm  
Handle - 125 mm

Rosetta - Bocchetta - 72x40x2 mm  
Rosette - Escutcheon plate - 72x40x2 mm



**Martellina D K - Dry keep**

**Art. 2505**

Impugnatura - 125 mm  
Handle - 125 mm

Scatola - 65x32x12 mm  
Raised backplate - 65x32x12 mm



**Martellina con rosetta**  
**Window handle with rosette**

**Art. 2502**

Impugnatura - 112 mm  
Handle - 112 mm

Rosetta - 72x40x2 mm  
Rosette - 72x40x2 mm





Collezione

“Madrid”

“Madrid” Collection



*Nero antico - Antique black*



Art. 2102



**Martellina - Cremonese**  
**Window handle - Cremonese bolt**

Art. 2102

Impugnatura - 115 mm  
Handle - 115 mm

Placca - 200x40x2 mm  
Backplate - 200x40x2 mm

**Martellina - Cremonese**  
**Window handle - Cremonese bolt**

Art. 2099

Impugnatura - 115 mm  
Handle - 115 mm

Placca a scatola - 135x35x11 mm  
Raised backplate - 135x35x11 mm



Art. 2099

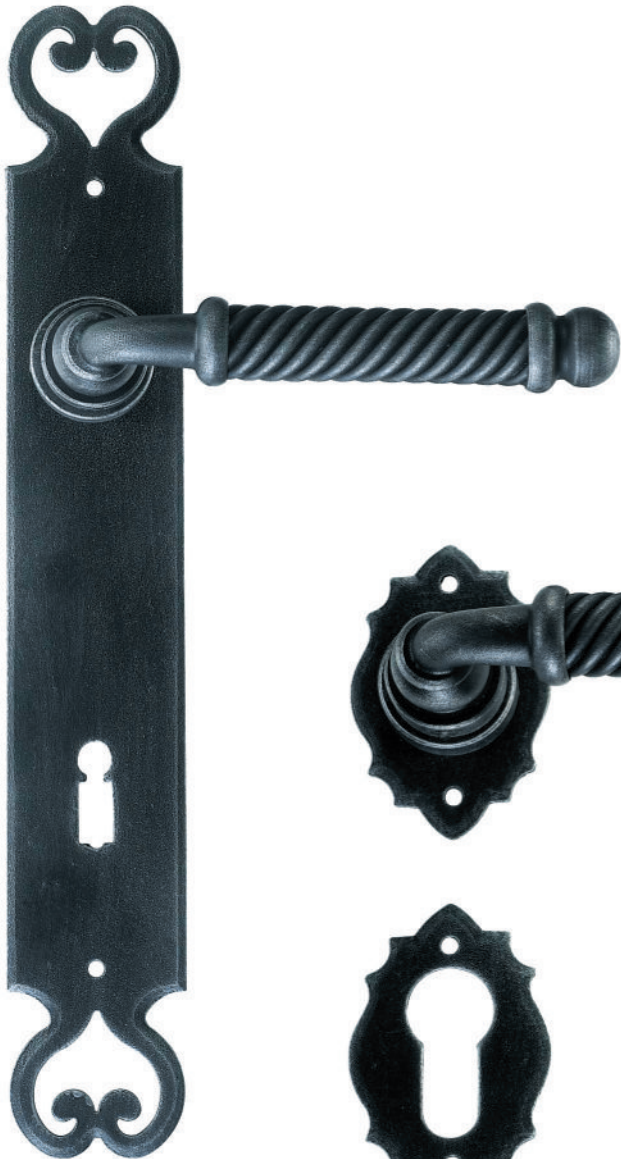

Art. 2100



Art. 2101



Art. 2098



Art. 2103



Maniglia per porta  
 Door handle

Art. 2100

Impugnatura - 120 mm  
 Handle - 120 mm

Placca - 260x40x2 mm  
 Backplate - 260x40x2 mm

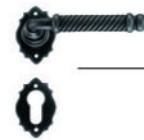

Maniglia per porta  
 Door handle

Art. 2101

Impugnatura - 120 mm  
 Handle - 120 mm

Rosetta - Bocchetta - 60x40x2 mm  
 Rosette - Escutcheon plate - 60x40x2 mm



Maniglia D K - Dry keep

Art. 2103

Impugnatura - 120 mm  
 Handle - 120 mm

Scatola - 65x32x12 mm  
 Raised backplate - 65x32x12 mm



Maniglia con rosetta  
 Window handle with rosette

Art. 2098

Impugnatura - 115 mm  
 Handle - 115 mm

Rosetta - 60x40x2 mm  
 Rosette - 60x40x2 mm

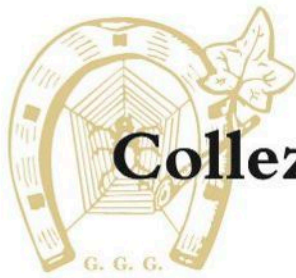

Collezione

“Lisbona”

“Lisbon” Collection



Grigio ferro chiaro - *Light grey*

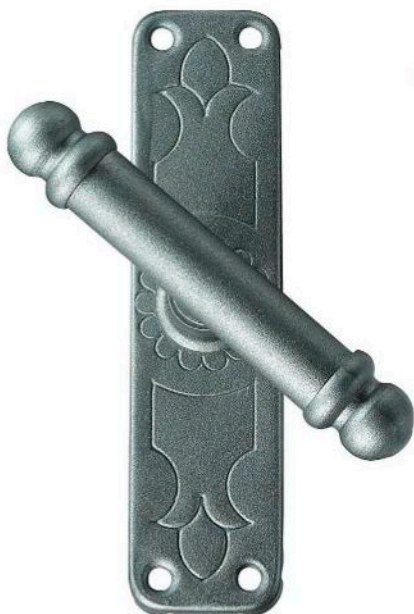

Art. 2107



**Martellina - Cremonese**  
Window handle - Cremonese bolt

Art. 2107

Impugnatura - 105 mm  
Handle - 105 mm

Placca a scatola - 135x35x11 mm  
Raised backplate - 135x35x11 mm

**Martellina**  
Window handle

Art. 2106

Impugnatura - 105 mm  
Handle - 105 mm

Placca - 140x40x2 mm  
Backplate - 140x40x2 mm

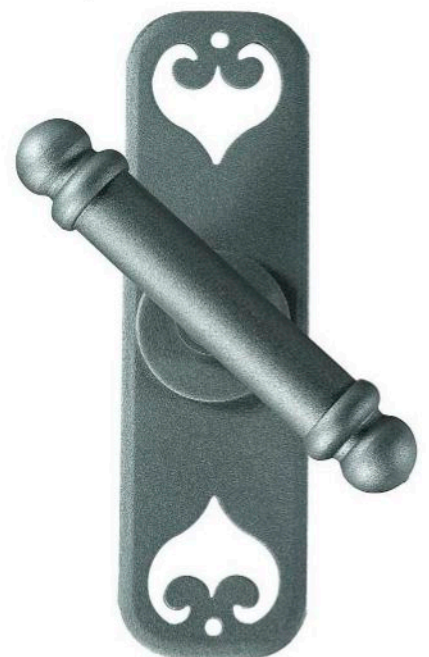

Art. 2106





Art. 2104



Art. 2105



**Maniglia per porta**  
**Door handle**

**Art. 2104**

Impugnatura - 120 mm  
 Handle - 120 mm

Placca - 240x40x2 mm  
 Backplate - 240x40x2 mm

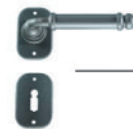

**Maniglia per porta**  
**Door handle**

**Art. 2105**

Impugnatura - 120 mm  
 Handle - 120 mm

Rosetta - Bocchetta - 60x40x2 mm  
 Rosette - Escutcheon plate - 60x40x2 mm

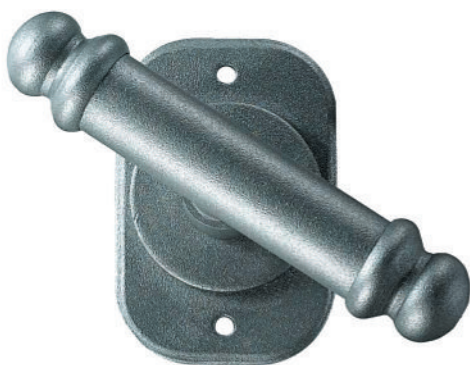

Art. 2097



Art. 2108



**Martellina D K - Dry keep**

**Art. 2108**

Impugnatura - 120 mm  
 Handle - 120 mm

Scatola - 65x32x12 mm  
 Raised backplate - 65x32x12 mm



**Martellina con rosetta**  
**Window handle with rosette**

**Art. 2097**

Impugnatura - 105 mm  
 Handle - 105 mm

Rosetta - 60x40x2 mm  
 Rosette - 60x40x2 mm



Collezione

“Berna”

“Bern” Collection



Nero ramato - Copper black



Art. 2111



Martellina - Cremonese  
Window handle - Cremonese bolt

Art. 2111

Impugnatura - 100 mm  
Handle - 100 mm

Placca a scatola - 135x35x11 mm  
Raised backplate - 135x35x11 mm

Cremonese AP per aste esterne  
Cremonese bolt for external rod

Art. 2111/319

Impugnatura - 100 mm  
Handle - 100 mm

Placca a scatola - 125x32 mm  
Raised backplate - 125x32 mm



Art. 2111/319



Art. 2109



Art. 2094



Maniglia per porta  
Door handle

Art. 2094

Impugnatura - 120 mm  
Handle - 120 mm

Rosetta - Bocchetta - 66x30x2 mm  
Rosette - Escutcheon plate - 66x30x2 mm



Maniglia per porta  
Door handle

Art. 2109

Impugnatura - 120 mm  
Handle - 120 mm

Placca - 250x45x2 mm  
Backplate - 250x45x2 mm



Maniglia per porta  
Door handle

Art. 2110

Impugnatura - 120 mm  
Handle - 120 mm

Rosetta - Bocchetta - 60x40x2 mm  
Rosette - Escutcheon plate - 60x40x2 mm



Art. 2110



Martellina con rosetta  
Window handle with rosette

Art. 2096

Impugnatura - 100 mm  
Handle - 100 mm

Rosetta - 60x40x2 mm  
Rosette - 60x40x2 mm



Art. 2112



Martellina con rosetta  
Window handle with rosette

Art. 2095

Impugnatura - 100 mm  
Handle - 100 mm

Rosetta - 66x30x2 mm  
Rosette - 66x30x2 mm

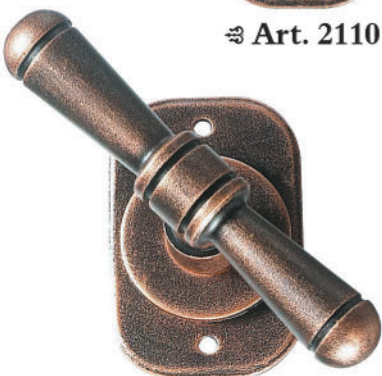

Art. 2096



Art. 2095



Martellina D K - Dry keep

Art. 2112

Impugnatura - 120 mm  
Handle - 120 mm

Scatola - 65x32x12 mm  
Raised backplate - 65x32x12 mm

Collezione Mosca

Moscow collection

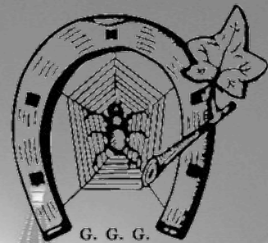

**Art.2700**

Impugnatura/Lever 125mm  
Placca/Plate 240X40mm  
**Art.2700/M con molla di ritorno**  
*Art.2700/M with return spring*



**Art.2696**

Impugnatura/Lever 125mm  
Placca/Plate 260X40mm  
**Art.2696/M con molla di ritorno**  
*Art.2696/M with return spring*



**Art.2703**

Impugnatura/Lever 100mm  
Placca/Plate 140X40X2mm



**Art.2704**

Impugnatura/Lever 100mm  
Placca/Plate 135X35X11mm



**Art.2701**

Impugnatura/Lever 125mm  
Rosette/Rosettes 64X40mm  
**Art.2701/M con molla di ritorno**  
**Art.2701/M with return spring**



**Art.2705**

Impugnatura/Lever 125mm  
Placca/Plate 65X32X12mm



**Art.2699**

Impugnatura/Lever 125mm  
Rosette/Rosettes Ø50mm  
**Art.2699/M con molla di ritorno**  
**Art.2699/M with return spring**



**Art.2702**

Impugnatura/Lever 100mm  
Rosetta/Rosette 64X40mm



**Art.2698**

Impugnatura/Lever 125mm  
Rosette/Rosettes 66X30mm  
**Art.2698/M con molla di ritorno**  
**Art.2698/M with return spring**



**Art.2702/2095**

Impugnatura/Lever 100mm  
Rosetta/Rosette 66X30mm

# Collezione Budapest

# Budapest collection

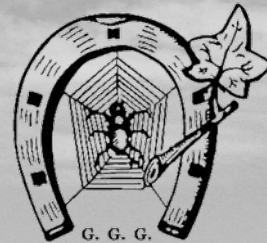

Art.2800

Impugnatura/Lever 125mm  
Placca/Plate 250X40mm  
**Art.2800/M con molla di ritorno**  
**Art.2800/M with return spring**



Art.2805

Impugnatura/Lever 125mm  
Placca/Plate 65X32X12mm



Art.2801

Impugnatura/Lever 125mm  
Rosette/Rosettes 72x40mm  
**Art.2801/M con molla di ritorno**  
**Art.2801/M with return spring**





Art.2798

Impugnatura/Lever 125mm  
Rosette/Rosettes 66x30mm  
Art.2798/M con molla di ritorno  
Art.2798/M with return spring



Art.2804

Impugnatura/Lever 100mm  
Placca/Plate 135X35X11mm



Art.2799

Impugnatura/Lever 125mm  
Rosette/Rosettes Ø50mm  
Art.2799/M con molla di ritorno  
Art.2799/M with return spring



Art.2803

Impugnatura/Lever 100mm  
Placca/Plate 200X40mm



Art.2802

Impugnatura/Lever 100mm  
Rosetta/Rosette 72X40mm

Collezione Tassin

Tassin collection



Art.1900

Impugnatura/Lever 110mm  
Placca/Plate 220X40mm  
Art.1900/M con molla di ritorno  
Art.1900/M with return spring



Art.1899

Impugnatura/Lever 110mm  
Placca/Plate 240X40mm  
Art.1899/M con molla di ritorno  
Art.1899/M with return spring



Art.1901

Impugnatura/Lever 110mm  
Rosette/Rosettes 50X40mm  
Art.1901/M con molla di ritorno  
Art.1901/M with return spring

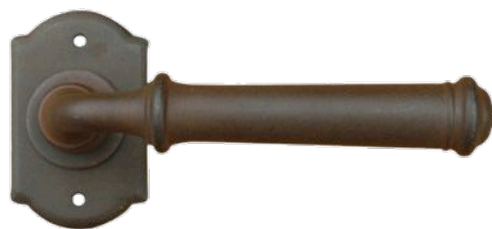

Art.1902

Impugnatura/Lever 110mm  
Rosette/Rosettes 64X40mm  
Art.1902/M con molla di ritorno  
Art.1902/M with return spring







**Art.1903**

Impugnatura/Lever 110mm  
 Rosette/Rosettes 70X45mm  
**Art.1903/M con molla di ritorno**  
**Art.1903/M with return spring**



**Art.1907**

Maniglia per finestra □ 7mm  
 Int. 43mm Viti M5X30  
 Rosetta 66X30mm  
*DK Window Handle* □7mm  
*Axe 43mm Screws M5X30*  
*Rosette 66X30mm*



**Art.1904**

Impugnatura/Lever 110mm  
 Rosette/Rosettes 66X30mm  
**Art.1904/M con molla di ritorno**  
**Art.1904/M with return spring**



**Art.1905**

Martellina DK  
 Scatola 65X32X12mm  
*DK Window Handle*  
*Raised Backplate 65X32X12 mm*

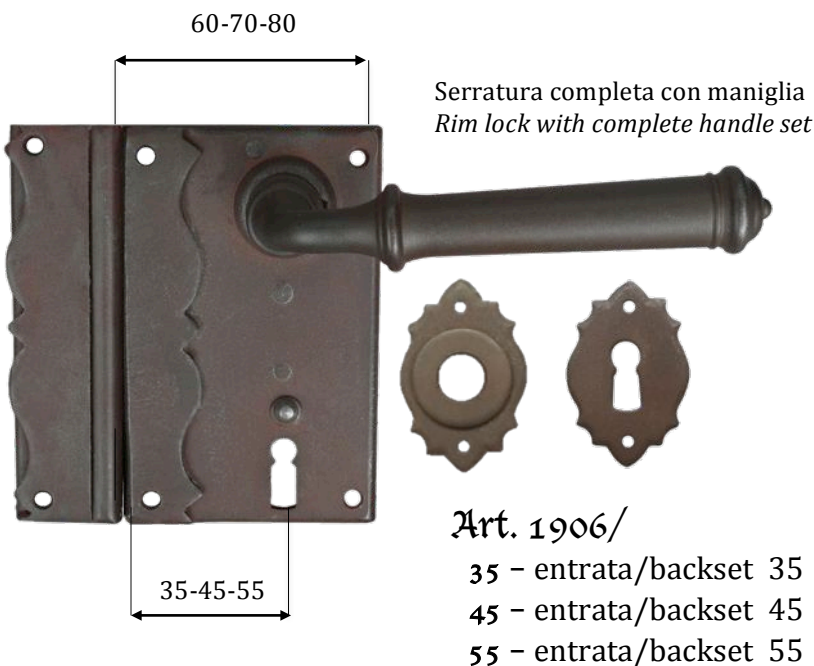

Serratura completa con maniglia  
*Rim lock with complete handle set*

**Art. 1906/**  
 35 - entrata/backset 35  
 45 - entrata/backset 45  
 55 - entrata/backset 55



**Art.14-10**

Nottolino WC -Rosetta 50X40mm  
 □ 5-6-7-8 mm  
*Privacy snib -Rosette 50X40mm*  
 □ 5-6-7-8 mm

# Collezione Monaco

# Munich collection



## Art.2900

Impugnatura/Lever 115mm  
Placca/Plate 240X40mm  
**Art.2900/M con molla di ritorno**  
**Art.2900/M with return spring**

## Art.2899

Impugnatura/Lever 140mm  
Placca/Plate 252X52mm  
**Art.2899/M con molla di ritorno**  
**Art.2899/M with return spring**



## Art.2901

Impugnatura/Lever 115mm  
Rosetta/Rosettes Ø 50mm  
**Art.2901/M con molla di ritorno**  
**Art.2901/M with return spring**



## Art.2905

Martellina DK  
Scatola 65X32X12mm  
**DK Window Handle**  
**Raised Backplate 65X32X12 mm**



## Art.2906

Maniglia per finestra □ 7mm  
Int.43mm Viti M5X30  
Rosetta 66X30mm  
**DK Window Handle □7mm**  
**Axe 43mm Screws M5X30**  
**Rosette 66X30mm**

# Collezione Brema



# Bremen collection



## Art.2950

Impugnatura/Lever 130mm  
Placca/Plate 240X40mm  
**Art.2950/M con molla di ritorno**  
**Art.2950/M with return spring**



## Art.2951

Impugnatura/Lever 130mm  
Rosette/Rosettes Ø 50mm  
**Art.2951/M con molla di ritorno**  
**Art.2951/M with return spring**



## Art.2955

Martellina DK  
Scatola 65X32X12mm  
*DK Window Handle*  
*Raised Backplate 65X32X12 mm*



## Art.2956

Maniglia per finestra □ 7mm  
Int.43mm Viti M5X30  
Rosetta 66X30mm  
*DK Window Handle* □7mm  
*Axe 43mm Screws M5X30*  
*Rosette 66X30mm*

# Collezione Salisburgo

# Salzburg collection



## Art.2850

Impugnatura/Lever 125mm  
Placca/Plate 240X40mm  
**Art.2850/M con molla di ritorno**  
*Art.2850/M with return spring*

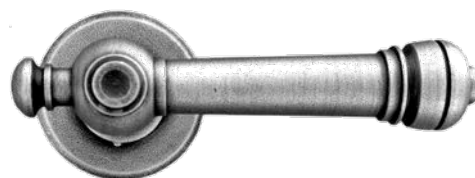

## Art.2851

Impugnatura/Lever 125mm  
Rosette/Rosettes Ø 50mm  
**Art.2851/M con molla di ritorno**  
*Art.2851/M with return spring*



## Art.2855

Martellina DK  
Scatola 65X32X12mm  
*DK Window Handle*  
*Raised Backplate 65X32X12 mm*



## Art.2856

Maniglia per finestra □ 7mm  
Int.43mm Viti M5X30  
Rosetta 66X30mm  
*DK Window Handle □7mm*  
*Axe 43mm Screws M5X30*  
*Rosette 66X30mm*

# Collezione Stoccolma

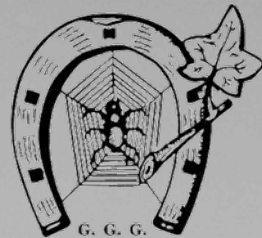

# Stockholm collection



## Art.1820

Impugnatura/Lever 110mm  
Placca/Plate 220X40mm  
**Art.1820/M con molla di ritorno**  
**Art.2850/M with return spring**



## Art.1821

Impugnatura/Lever 110mm  
Rosette/Rosettes 50X40mm  
**Art.1821/M con molla di ritorno**  
**Art.1821/M with return spring**



## Art.1822

Maniglia per finestra 86mm  
Int.43mm Viti M5X30  
Rosetta 75X30mm  
**DK Window Handle 86mm**  
**Axe 43mm Screws M5X30**  
**Rosette 75X30mm**



## Art.1823

Martellina DK  
Scatola 65X32X12mm  
**DK Window Handle**  
**Raised Backplate 65X32X12mm**

# Collezione Helsinki



# Helsinki collection



## Art.1810

Impugnatura/Lever 100mm  
Placca/Plate 240X30mm  
Art.1810/M con molla di ritorno  
Art.1810/M with return spring



## Art.1811

Impugnatura/Lever 100mm  
Rosette/Rosettes 66X30mm  
Art.1811/M con molla di ritorno  
Art.1811/M with return spring



## Art.1812

Maniglia per finestra 86mm  
Int.43mm Viti M5X30  
Rosetta 66X30mm  
DK Window Handle 86mm  
Axe 43mm Screws M5X30  
Rosette 66X30mm



## Art.1813

Martellina DK  
Scatola 65X32X12mm  
DK Window Handle  
Raised Backplate 65X32X12 mm

# Collezione Misano



# Misano collection



**Art.1830**

Impugnatura/*Lever* 120mm  
Placca/*Plate* 220X40mm  
**Art.1830/M con molla di ritorno**  
*Art.1830/M with return spring*



**Art.1831**

Impugnatura/*Lever* 120mm  
Rosette/*Rosettes* 50X40mm  
**Art.1831/M con molla di ritorno**  
*Art.1831/M with return spring*



**Art.1833**

Impugnatura/*Lever* 120mm  
Rosette/*Rosettes* Ø 50mm  
**Art.1833/M con molla di ritorno**  
*Art.1833/M with return spring*



**Art.1832**

Maniglia per finestra 100mm  
Int.43mm Viti M5X30  
Rosetta 75X30mm  
*Window Handle 100mm*  
*Axe 43mm Screws M5X30*  
*Rosette 75X30mm*



**Art.1835**

Martellina DK  
Scatola 65X32X12mm  
*DK Window Handle*  
*Raised Backplate 65X32X12 mm*



Collezione

“Parigi”

“Paris” Collection



Antichizzato ruggine - Antique rust



⌘ D23

⌘ Art. 2603



Martellina  
Window handle

Art. 2603 + D23

Impugnatura porcellana “Bavaria” - 112 mm  
“Bavaria” porcelain handle - 112 mm

Piastra - 200x40x2 mm  
Backplate - 200x40x2 mm

Martellina - Cremonese  
Window handle - Cremonese bolt

Art. 2604 + D23

Impugnatura porcellana “Bavaria” - 112 mm  
“Bavaria” porcelain handle - 112 mm

Placca a scatola - 135x35x11 mm  
Raised backplate - 135x35x11 mm



⌘ D23

⌘ Art. 2604





Collezione **"Parigi"**  
**"Paris"** Collection



☪ D22

☪ Art. 2600



☪ D22



☪ Art. 2601



☪ D22



☪ D22

☪ Art. 2605



☪ D23

☪ Art. 2602

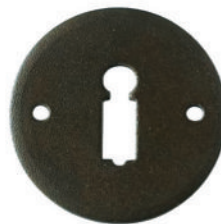

☪ Art. 3-10



**Maniglia per porta - Door handle**

Art. 2600 + D22

Impugnatura porcellana "Bavaria" - 125 mm  
 "Bavaria" porcelain handle - 125 mm

Placca - 260x40x2 mm  
 Backplate - 260x40x2 mm



**Maniglia per porta - Door handle**

Art. 2601 + D22

Impugnatura porcellana "Bavaria" - 125 mm  
 "Bavaria" porcelain handle - 125 mm

Rosetta - Bocchetta - 60x40x2 mm  
 Rosette - Escutcheon plate - 60x40x2 mm



**Maniglia per porta - Door handle**

Art. 3-10 + D22

Impugnatura porcellana "Bavaria" - 125 mm  
 "Bavaria" porcelain handle - 125 mm

Rosetta - Bocchetta - Ø50x2 mm  
 Rosette - Escutcheon plate - Ø50x2 mm



**Martellina D K - Dry keep**

Art. 2605 + D22

Impugnatura porcellana "Bavaria" - 125 mm  
 "Bavaria" porcelain handle - 125 mm

Scatola - 65x32x12 mm  
 Raised backplate - 65x32x12 mm



**Martellina con rosetta  
 Window handle with rosette**

Art. 2602 + D23

Impugnatura porcellana "Bavaria" - 112 mm  
 "Bavaria" porcelain handle - 112 mm

Rosetta - 60x40x2 mm  
 Rosette - 60x40x2 mm



# Collezione “Atene”

# “Athens” Collection



**Nero antico - Antique black**



⌘ D21

⌘ Art. 2613/319



**Cremonese AP per aste esterne**  
**Cremonese bolt for external rods**

Art. 2613/319 + D21

Impugnatura porcellana “Bavaria” - 112 mm  
 “Bavaria” porcelain handle - 112 mm

Placca Scatola - 125x32 mm  
 Raised backplate - 125x32 mm

**Martellina - Cremonese**  
**Window handle - Cremonese bolt**

Art. 2613 + D21

Impugnatura porcellana “Bavaria” - 112 mm  
 “Bavaria” porcelain handle - 112 mm

Placca a scatola - 135x35x11 mm  
 Raised backplate - 135x35x11 mm



⌘ D21

⌘ Art. 2613



☞ D20

☞ Art. 2609



☞ D20



☞ Art. 2610



☞ D21

☞ Art. 2611



☞ D21

☞ Art. 2612



☞ D20

☞ Art. 2615



**Maniglia per porta - Door handle**

Art. 2609 + D20

Impugnatura porcellana "Bavaria" - 125 mm  
"Bavaria" porcelain handle - 125 mm

Placca - 250x45x2 mm  
Backplate - 250x45x2 mm



**Maniglia per porta - Door handle**

Art. 2610 + D20

Impugnatura porcellana "Bavaria" - 125 mm  
"Bavaria" porcelain handle - 125 mm

Rosetta - Bocchetta - 60x40x2 mm  
Rosette - Escutcheon plate - 60x40x2 mm



**Martellina con rosetta  
Window handle with rosette**

Art. 2611 + D21

Impugnatura porcellana "Bavaria" - 112 mm  
"Bavaria" porcelain handle - 112 mm

Rosetta - 66x30x2 mm  
Rosette - 66x30x2 mm



**Martellina - Window handle**

Art. 2612 + D21

Impugnatura porcellana "Bavaria" - 112 mm  
"Bavaria" porcelain handle - 112 mm

Piastra - 140x40x2 mm  
Backplate - 140x40x2 mm



**Martellina D K - Dry keep**

Art. 2615 + D20

Impugnatura porcellana "Bavaria" - 125 mm  
"Bavaria" porcelain handle - 125 mm

Scatola - 65x32x12 mm  
Raised backplate - 65x32x12 mm



Collezione

“Vienna”

“Wien” Collection



Verde oro antico - *Antique gold green*



⌘ D2

⌘ Art. 1-40



**Martellina**  
**Window handle**

Art. 1-40 + D2

Impugnatura porcellana “Bavaria” - 112 mm  
“Bavaria” porcelain handle - 112 mm

Piastra - 200x40x2 mm  
Backplate - 200x40x2 mm

**Martellina - Cremonese**  
**Window handle - Cremona bolt**

Art. 1-50 + D2

Impugnatura porcellana “Bavaria” - 112 mm  
“Bavaria” porcelain handle - 112 mm

Placca Scatola - 135x35x11 mm  
Raised backplate - 135x35x11 mm



⌘ D2

⌘ Art. 1-50

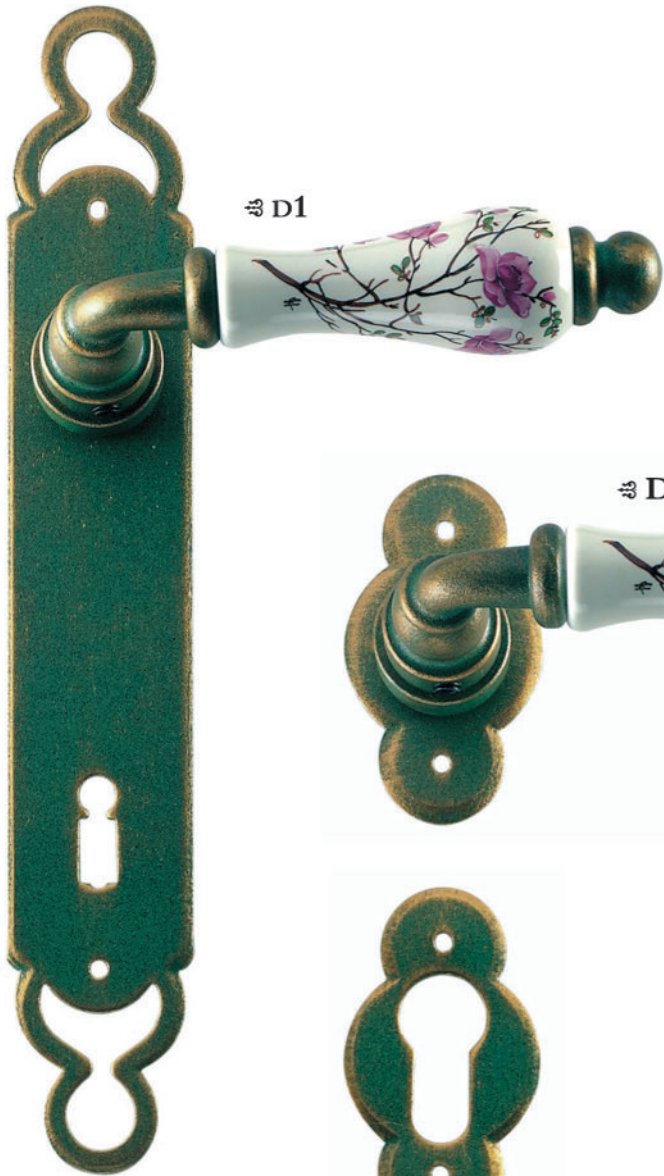

Art. 1-10

D1

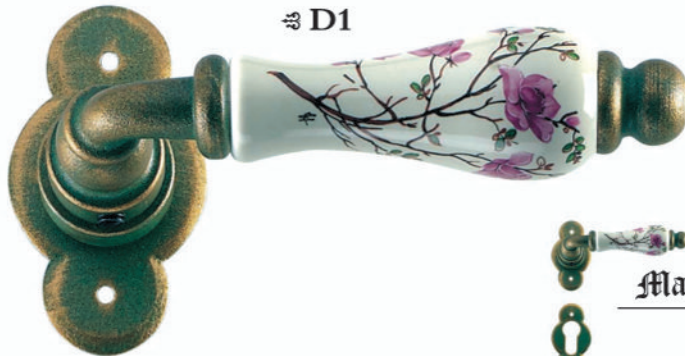

Art. 1-20

D1



**Maniglia per porta - Door handle**

Art. 1-10 + D1

Impugnatura porcellana “Bavaria” - 125 mm  
 “Bavaria” porcelain handle - 125 mm

Placca - 250x40x2 mm  
 Backplate - 250x40x2 mm



**Maniglia per porta - Door handle**

Art. 1-20 + D1

Impugnatura porcellana “Bavaria” - 125 mm  
 “Bavaria” porcelain handle - 125 mm

Rosetta - 72x40x2 mm  
 Rosette - 72x40x2 mm

Bocchetta - 72x40x2 mm  
 Escutcheon plate - 72x40x2 mm



**Martellina con rosetta**  
**Window handle with rosette**

Art. 1-30 + D2

Impugnatura porcellana “Bavaria” - 112 mm  
 “Bavaria” porcelain handle - 112 mm

Rosetta - 72x40x2 mm  
 Rosette - 72x40x2 mm

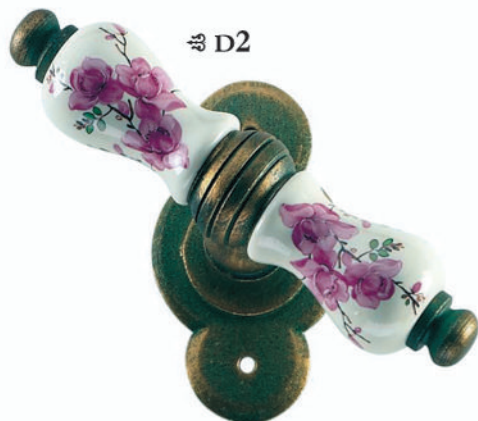

Art. 1-30

D2



Art. 1-60

D1



**Martellina D K - Dry keep**

Art. 1-60 + D1

Impugnatura porcellana “Bavaria” - 125 mm  
 “Bavaria” porcelain handle - 125 mm

Scatola - 65x32x12 mm  
 Raised backplate - 65x32x12 mm



Collezione

“Praga”

“Prague” Collection



*Antichizzato ruggine - Antique rust*



≡ D6

≡ Art. 2-40



**Martellina**  
**Window handle**

Art. 2-40 + D6

Impugnatura porcellana “Bavaria” - 112 mm  
“Bavaria” porcelain handle - 112 mm

Piastra - 140x40x2 mm  
Backplate - 140x40x2 mm



≡ D6

≡ Art. 2-50

**Martellina - Cremonese**  
**Window handle - Cremona bolt**

Art. 2-50 + D6

Impugnatura porcellana “Bavaria” - 112 mm  
“Bavaria” porcelain handle - 112 mm

Placca a scatola - 135x35x11 mm  
Raised backplate - 135x35x11 mm



Art. 2-10

D5

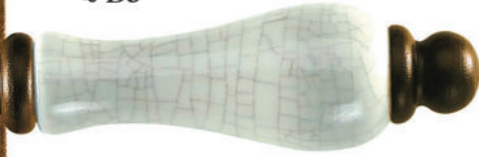

D5



Art. 2-20



Art. 5-90



Art. 2-60

D5

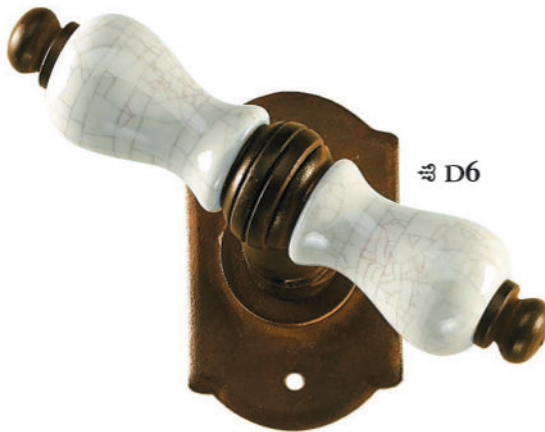

Art. 2-30

D6



**Maniglia per porta - Door handle**

Art. 2-10 + D5

Impugnatura porcellana “Bavaria” - 125 mm  
 “Bavaria” porcelain handle - 125 mm

Placca - 240x40x2 mm  
 Backplate - 240x40x2 mm



**Maniglia per porta - Door handle**

Art. 2-20 + D5

Impugnatura porcellana “Bavaria” - 125 mm  
 “Bavaria” porcelain handle - 125 mm

Rosetta - 64x40x2 mm  
 Rosette - 64x40x2 mm

Bocchetta - 64x40x2 mm  
 Escutcheon plate - 64x40x2 mm



**Pendente - Pendant**

Art. 5-90 Craquelè/Crackled

Pendente - 72 mm  
 Furniture pendant pull - 72 mm

Rosetta - Ø35 mm  
 Rosette - Ø35 mm



**Martellina D K - Dry keep**

Art. 2-60 + D5

Impugnatura porcellana “Bavaria” - 125 mm  
 “Bavaria” porcelain handle - 125 mm

Scatola - 65x32x12 mm  
 Raised backplate - 65x32x12 mm



**Martellina con rosetta  
 Window handle with rosette**

Art. 2-30 + D6

Impugnatura porcellana “Bavaria” - 112 mm  
 “Bavaria” porcelain handle - 112 mm

Rosetta - 64x40x2 mm  
 Rosette - 64x40x2 mm



Collezione

# “Copenaghen” “Copenhagen” Collection



*Nero antico - Antique black*



⌘ D10

⌘ Art. 2623



**Martellina**  
**Window handle**

Art. 2623 + D10

Impugnatura porcellana “Bavaria” - 112 mm  
“Bavaria” porcelain handle - 112 mm

Placca - 140x40x2 mm  
Backplate - 140x40x2 mm

**Martellina - Cremonese**  
**Window handle - Cremona bolt**

Art. 2624 + D10

Impugnatura porcellana “Bavaria” - 112 mm  
“Bavaria” porcelain handle - 112 mm

Placca a scatola - 135x35x11 mm  
Raised backplate - 135x35x11 mm



⌘ D10

⌘ Art. 2624





Collezione **“Copenhagen”**  
**“Copenhagen”** Collection



☪ D9

☪ Art. 2620



☪ D9

☪ Art. 2621



☪ D9

☪ Art. 3-10



☪ D9

☪ Art. 2625



☪ D10

☪ Art. 2622



**Maniglia per porta - Door handle**

Art. 2620 + D9

Impugnatura porcellana “Bavaria” - 125 mm  
 “Bavaria” porcelain handle - 125 mm

Placca - 240x40x2 mm  
 Backplate - 240x40x2 mm



**Maniglia per porta - Door handle**

Art. 2621 + D9

Impugnatura porcellana “Bavaria” - 125 mm  
 “Bavaria” porcelain handle - 125 mm

Rosetta - Bocchetta - 60x40x2 mm  
 Rosette - Escutcheon plate - 60x40x2 mm



**Maniglia per porta - Door handle**

Art. 3-10 + D9

Impugnatura porcellana “Bavaria” - 125 mm  
 “Bavaria” porcelain handle - 125 mm

Rosetta - Bocchetta - Ø50x2 mm  
 Rosette - Escutcheon plate - Ø50x2 mm



**Martellina D K - Dry keep**

Art. 2625 + D9

Impugnatura porcellana “Bavaria” - 125 mm  
 “Bavaria” porcelain handle - 125 mm

Scatola - 65x32x12 mm  
 Raised backplate - 65x32x12 mm



**Martellina con rosetta  
 Window handle with rosette**

Art. 2622 + D10

Impugnatura porcellana “Bavaria” - 112 mm  
 “Bavaria” porcelain handle - 112 mm

Rosetta - 60x40x2 mm  
 Rosette - 60x40x2 mm

# Collezione Amsterdam



# Amsterdam collection



Ø 13

**Art.5-10**

Impugnatura/Lever 125mm  
Placca/Plate 220X40mm  
**Art.5-10/M con molla di ritorno**  
**Art.5-10/M with return spring**

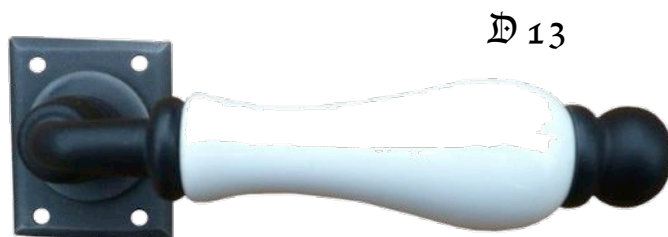

Ø 13

**Art.5-20**

Impugnatura/Lever 125mm  
Rosette/Rosettes 50X40mm  
**Art.5-20 /M con molla di ritorno**  
**Art.5-20/M with return spring**



Ø 14

**Art.5-40**

Martellina DK 112mm  
Scatola 65X32X12mm  
*DK Window Handle 112mm*  
*Raised Backplate 65X32X12 mm*



Ø 14

**Art.5-30**

Maniglia per finestra 112mm  
Int.43mm Viti M5X30  
Rosetta 75X30mm  
*Window Handle 112mm*  
*Axe 43mm Screws M5X30*  
*Rosette 75X30mm*

# Collezione Dublino



## Dublin collection

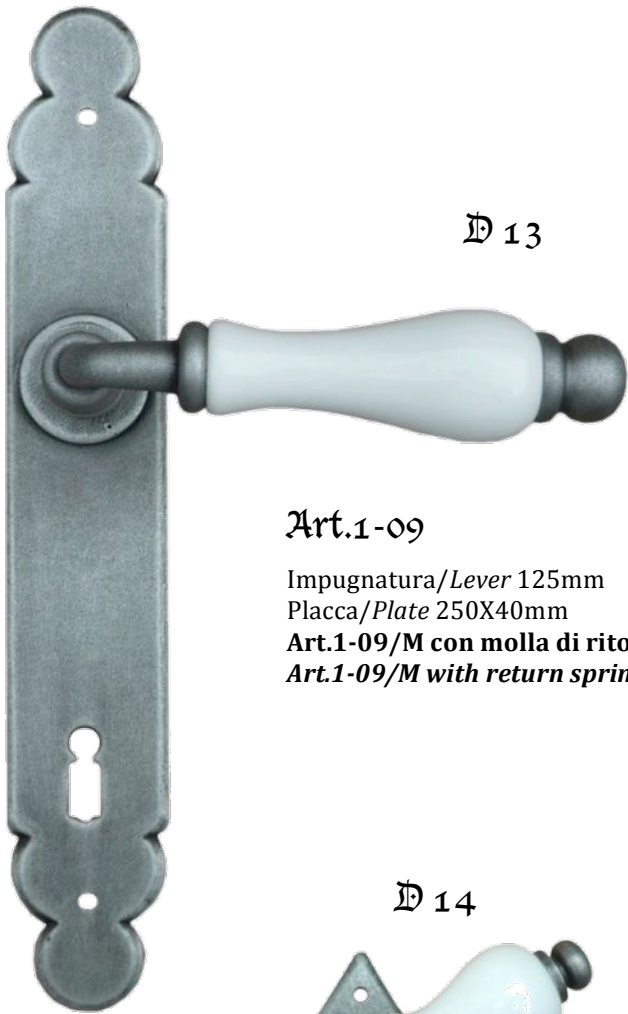

D 13

**Art.1-09**

Impugnatura/Lever 125mm  
Placca/Plate 250X40mm  
**Art.1-09/M con molla di ritorno**  
**Art.1-09/M with return spring**



D 13

**Art.4-10**

Impugnatura/Lever 125mm  
Rosette/Rosettes 70X45mm  
**Art.4-10 /M con molla di ritorno**  
**Art.4-10/M with return spring**



D 14

**Art.4-20**

Martellina 112mm  
Rosetta 70X45mm  
Window Handle 112mm  
Rosette 70X30mm



D 13

**Art.1-08**

Impugnatura/Lever 125mm  
Rosette/Rosettes 66X30mm  
**Art.1-08 /M con molla di ritorno**  
**Art.1-08/M with return spring**





Collezione

# “Stile Antico”

Maniglie e Maniglioni

## “Antique Style” Collection

Door Handles and Pull handles



Maniglia per porta

Door handle

Art. 2220

Impugnatura - 130 mm  
Handle - 130 mm

Placca - 250x45x4 mm  
Backplate - 250x45x4 mm

Art. 2220



Art. 2214

Art. 2214/ZANC



Maniglione  
Pull handle

Art. 2214

Maniglione - 320x30x30 mm  
Pull handle - 320x30x30 mm

Rosette - 40x40 mm  
Rosettes - 40x40 mm



Maniglione zancato  
Cranked pull handle

Art. 2214/ZANC

Maniglione zancato - 320x30x30 mm  
Pull handle - 320x30x30 mm

Rosette - 55x35 mm  
Rosettes - 55x35 mm

Distanza sui centri - 30 mm  
Distance between centres - 30 mm



Maniglia per porta  
Door handle

Art. 2210

Impugnatura - 140 mm  
Handle - 140 mm

Placca - 400x80x4 mm  
Backplate - 400x80x4 mm



Art. 2210



Art. 2213

Art. 2213/ZANC



Maniglione  
Pull handle

Art. 2213

Maniglione - 360xØ50 mm  
Pull handle - 360xØ50 mm

Rosette - Ø60 mm  
Rosettes - Ø60 mm



Maniglione zancato  
Cranked pull handle

Art. 2213/ZANC

Maniglione zancato - 360xØ50 mm  
Pull handle - 360xØ50 mm

Rosette - 55x35 mm  
Rosettes - 55x35 mm

Distanza sui centri - 30 mm  
Distance between centres - 30 mm

# Battenti / Door Knockers



Art. 1700

Anello/Ring ■ 18X18XØ150mm  
Piastra/Plate 150X150



Art. 1701

Anello/Ring ■ 18X18XØ150mm  
Placca/Plate Ø80mm



Art. 2217

Anello/Ring Ø115mm  
Placca/Plate Ø70mm



Art. 2215

Anello/Ring Ø120mm  
Battente/Door Knocker 250X150mm

Art. 2215/A

Anello/Ring Ø80mm  
Battente/Door Knocker 150X100mm



Art. 2115

Anello/Ring Ø115mm  
Placca/Plate 70X70mm



Art. 1702

Placca/Plate  
190X50mm

# Placche per lettere / Letter plates



Art. 239

Placca/Plate 310X80mm  
Buca/Opening size 230X40mm



Art. 240

Placca/Plate 310X80mm  
Buca/Opening size 230X40mm



# Pomoli / Door Knobs



**Art. 2216**

Art.2216/A  
Pomolo/Knob Ø58mm  
Art.2216/B  
Pomolo/Knob Ø70mm



**Art. 1704**

Pomolo/Knob Ø70mm  
Rosetta/Rosette 150X150mm



**Art. 1703**

Art.1703/A  
Pomolo/Knob Ø58mm  
Rosetta/Rosette Ø80mm  
Art.1703/B  
Pomolo/Knob Ø70mm  
Rosetta/Rosette Ø80mm



**Art. 2116**

Pomolo/Knob Ø65mm  
Rosetta/Rosette Ø80mm



**Art. 2080**

Pomolo/Knob Ø60mm



**Art. 2081**

Pomolo/Knob Ø50mm



**Art. 2807**

Pomolo/Knob Ø80mm  
Rosetta/Rosette Ø70mm

# Maniglia "Provenza" / Door handle "Provence"

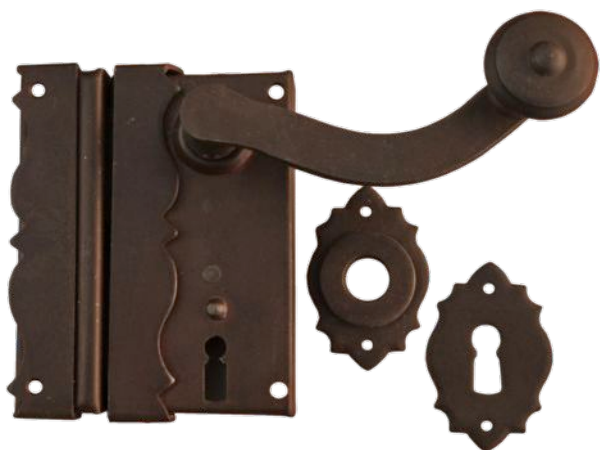

**Art. 5-43/ 35-45-55**

Serratura completa con maniglia  
Rim lock with complete handle set

35 - entrata/backset 35

45 - entrata/backset 45

55 - entrata/backset 55

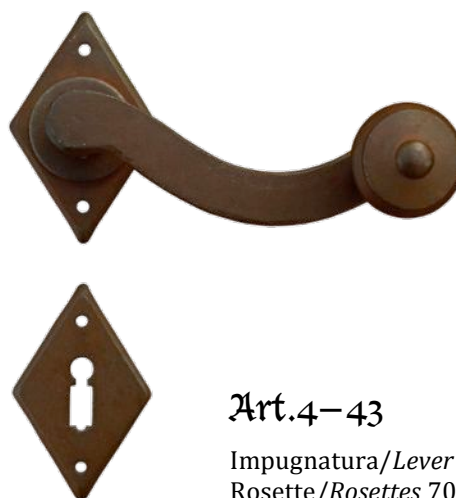

**Art.4-43**

Impugnatura/Lever 105mm  
Rosette/Rosettes 70X45mm

**Art.4-43/M con molla di ritorno**

**Art.4-43/M with return spring**

# Maniglioni/ Pull handles



**Art.2326**  
Maniglione/Door Pull  
760X270mm ■25X25mm



**Art.2327**  
Maniglione/Door Pull  
730X200mm ■16X16mm



**Art.2320**  
Maniglione/Door Pull 410mm - Ø25mm  
Rosette/Rosettes Ø68mm



**Art.2325**  
Maniglione/Door Pull  
1000mm Ø35mm



**Art.1879**  
Maniglione/Door Pull  
620mm - ■20X20mm  
Rosette/Rosettes 250X250mm



**Art.2328/A**  
Maniglione/Door Pull  
600mm Ø28mm

**Art.2328/B**  
Maniglione/Door Pull  
900mm Ø28mm



# Maniglioni/ Pull handles



Art.2513

Maniglione/Door Pull  
245mm Ø28mm  
Rosette/Rosettes Ø40mm



Art.2513/Zanc



Art.2413

Maniglione/Door Pull  
240mm Ø27mm  
Rosette/Rosettes Ø40mm



Art.2413/Zanc



Art.5-50 +D...

Maniglione/Door Pull  
250mm Ø28mm  
Rosette/Rosettes Ø40mm



Art.5-50 /Zanc+D...



Art.2113

Maniglione/Door Pull  
210mm Ø16mm  
Rosette/Rosettes Ø40mm



Art.2113/Zanc



# Maniglioni/ Pull handles



Art.2114

Maniglione/Door Pull 210mm Ø16mm  
Rosette/Rosettes Ø40mm



Art.2114/Zanc



Art.2014

Maniglione/Door Pull 180mm  
Placca/Plate 240X40mm



Art.2014/Zanc



Art.2119

Maniglione/Door Pull  
280mm Ø24mm  
Rosette/Rosettes Ø40mm



Art.2806/A

Maniglione/Door Pull  
175mm Ø30mm  
Rosette/Rosettes Ø40mm

Art.2806/B

Maniglione/Door Pull  
245mm Ø30mm  
Rosette/Rosettes Ø40mm



Art.2321

Maniglione/Door Pull  
350mm Ø27mm  
Rosette/Rosettes Ø50mm



Art.2322

Maniglione/Door Pull  
315mm Ø27mm  
Rosette/Rosettes Ø50mm



# Maniglioni/ Pull handles

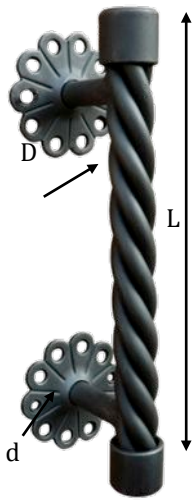

**Art.1865 /**  
 A D 20 L 200 d 20  
 B D 20 L 300 d 20  
 C D 25 L 400 d 25  
 D D 25 L 600 d 25

Maniglione  
Pull handle

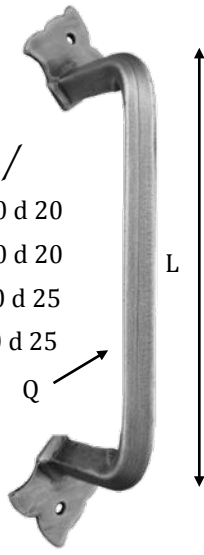

**Art.1860 /**  
 A Q 8X8 L 150  
 B Q 10X10 L 200  
 C Q 15X15 L 300  
 D Q 15X15 L 350

Maniglione  
Pull handle

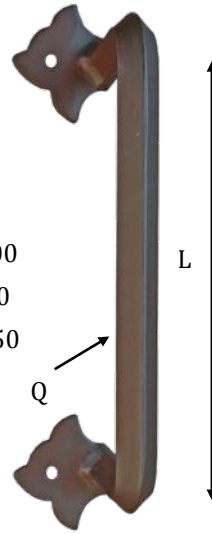

**Art.1861 /**  
 A Q 8X8 L 120  
 B Q 10X10 L 150  
 C Q 15X15 L 260  
 D Q 15X15 L 310

Maniglione zancato  
Crancked pull handle

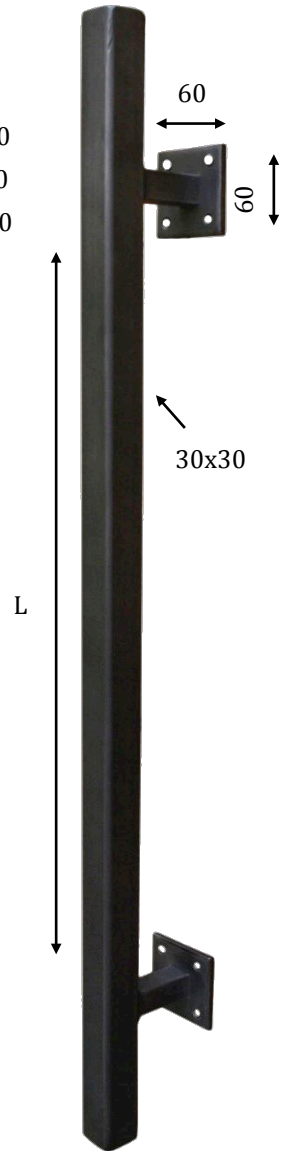

Maniglione  
Pull handle

**Art.1880 /**

- A L 600
- B L 800
- C L 1000
- D L 1200
- E L 1400
- F L 1600
- G L 1800
- H L 2000



**Art. 1870**

Maniglione zancato  
Crancked pull handle  
Placca/ plate 310x80mm  
Impugnatura/ lever Ø150x8x8mm



**Art.1875**

Maniglione zancato  
Crancked pull handle  
Placca/plate 170x80mm  
Impugnatura/ lever Ø150x8x8mm



**Art. 1877**

Maniglione / Door pull  
Placca/ Plate 240x30mm

# Maniglioni per Alzanti Scorrevoli Lift and Slide Handles



Placca / Plate 224X40mm – Maniglia a conchiglia / Shell Handle 148X40mm

Quadro/ Spindle 10X10mm

Disponibile: Maniglione+maniglia conchiglia – Maniglione Yale+maniglia a conchiglia – Copia maniglioni Yale

Available: Pull+Shell handles – Pull with profile Cylinder hole + shall handle – Pair of profile cylinder pulls



Art.2509

Impugnatura/Lever: 215 mm



Art.2510

Impugnatura/Lever: 220 mm



Art.2512

Impugnatura/Lever: 240 mm



Art.2511+D...

Impugnatura/Lever: 220 mm

## Maniglie per Scorrevoli / Sliding Door Pulls



Art.2128

Dimensioni:  
148X40 mm  
Prof: 10mm  
Size:  
148X40 mm  
Depth: 10mm



Art.2129

Dimensioni:  
148X40 mm  
Prof: 10mm  
Size:  
148X40 mm  
Depth: 10mm



Art.2130

Dimensioni:  
125X40 mm  
Prof: 13mm  
Size:  
125X40 mm  
Depth: 13mm



Art.2131

Dimensioni:  
125X40 mm  
Prof: 13mm  
Size:  
125X40 mm  
Depth: 13mm

## Maniglie ad Anello/ Ring Turn Handles



Art.1837CP

Copia di maniglie ad anello  
Pair of Turn Ring Handles  
Anello/ Ring : 75mm  
Rosetta/Rosette: 50mm  
Altezza/Height: 90mm

Art.1837

Maniglia ad anello (pezzo)  
Turn Ring Handle (each)



Art.1836CP

Copia di maniglie ad anello  
Pair of Turn Ring Handles  
Anello/ Ring : 65mm  
Rosetta/Rosette: 50mm  
Altezza/Height: 85mm

Art.1836

Maniglia ad anello (pezzo)  
Turn Ring Handle (each)



# Cremonesi Aste Esterne

## Cremonese Bolts for external rods



Art.327/2111



Art.127/111



Art.427/2705

### Art.127/...

Cremonese per aste esterne 16X5mm  
Placca 130X36X16sp - 5 accessori inclusi  
*Cremonese bolt for external rods 16X5mm*  
*Plate 130X36X16dep- 5 rod covers included*

### Art.327/...

Cremonese per aste esterne 16X8mm  
Placca 148X42X20sp - 5 accessori inclusi  
*Cremonese bolt for external rods 16X8mm*  
*Plate 148X42X20dep - 5 rod covers included*

### Art.427/...

Cremonese falsa con mov. DK o Q.7mm  
Placca 148X42X20sp - 5 accessori inclusi  
*Dummy cremone bolt with tilt & turn*  
*mechanism or 7mm spindle*  
*Plate 148X42X20dep - 5 rod covers included*



### Art.430

Aste mezzo-tondo 16X8mm  
*Half-round rod 16X8mm*

### Art.431

Aste mezzo-tondo 16X5mm  
*Half-round rod 16X5mm*

**Le aste mezzo-tondo sono fornite separatamente.**

*The half-round rods are supplied separately.*



### Art.432/6/10/14/19

Spessori per art.327  
2 pezzi possono essere montati insieme

*Height addition for art.327.*  
*Max 2 pieces can be mounted together*

SP: 6-10-14-19mm

SP



### Art.433

Passante  
Rod cover



### Art.327/111 - Ser

Disponibile per tutti i modelli su ordinazione.

Richiedere preventivo e tempi di consegna

*Available for all models on request.*

Please ask price and delivery time



# Cremonesi aste esterne

## Cremona bolt for external rods



Art. .../2704



Art. .../2404



Art. ...+D10



Art. .../2107



Art. .../2504



Art. .../2099



Art. .../2804



Art. .../2204



Art. .../544



Art. .../1100



Art. .../549



Art. .../111



Art. .../545



Art. .../902



Art. .../541



Art. .../316



Art. .../317



Art. .../1094

Tutte le mpugnature raffigurate sono disponibili su placca art.327 e art.127 o con movimento DK .  
All the illustrated levers are available with backplates art.327, art.127 or with tilt& turn mechanism.



# DK con serratura / Lockable tilt & turn



Art.227/2625+D9

Dimensioni:  
Placca a scatola:  
100X32X28mm  
Raised Backplate:  
100X32X28 mm



Art.227/2112

Dimensioni:  
Placca a scatola:  
100X32X28mm  
Raised Backplate:  
100X32X28 mm

DK con serratura è disponibile per tutte le impugnature  
DK lockable is available on all types of levers

## Serratura da applicare Entrare 35=45=55 mm Rim locks backset 35=45=55mm



Art.5850



Art.5850/Dek

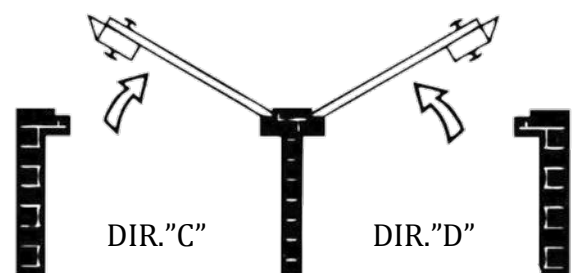
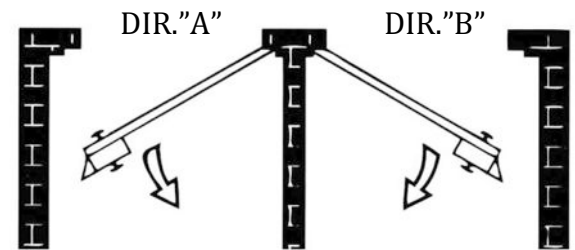
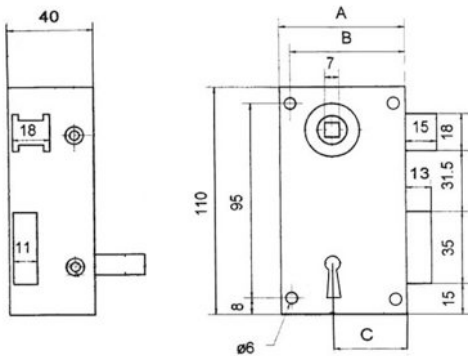

Le serrature sono fornite con 2 chiavi, rosetta e bocchetta esterne per art.5850/Dek oppure placca esterna per art.5850.

Impugnatura non è compresa

# Serrature da Applicare

## Rim Locks

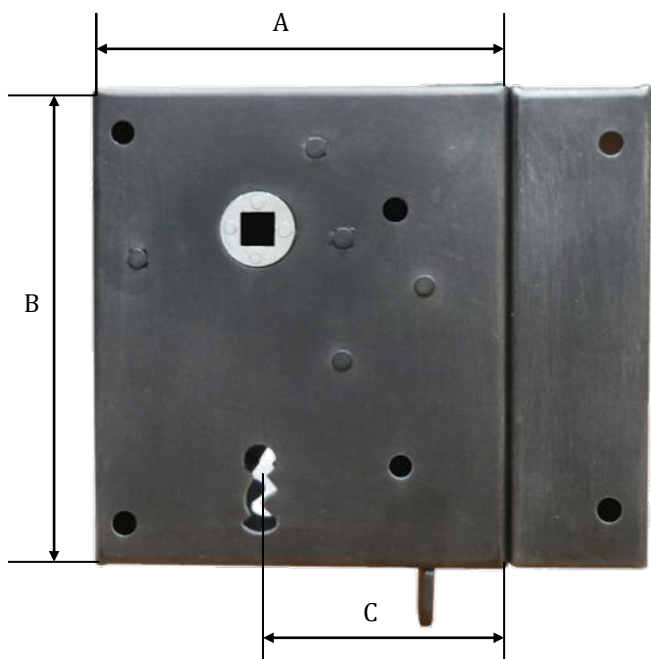

### Art. 5800

Serratura da applicare patent A 101 B 117 C 60  
Rim lock key A 101 B 117 C 60

### Art. 5800/Yale

Serratura da applicare yale A 101 B 117 C 60  
Rim lock with cylinder hole A 101 B 117 C 60

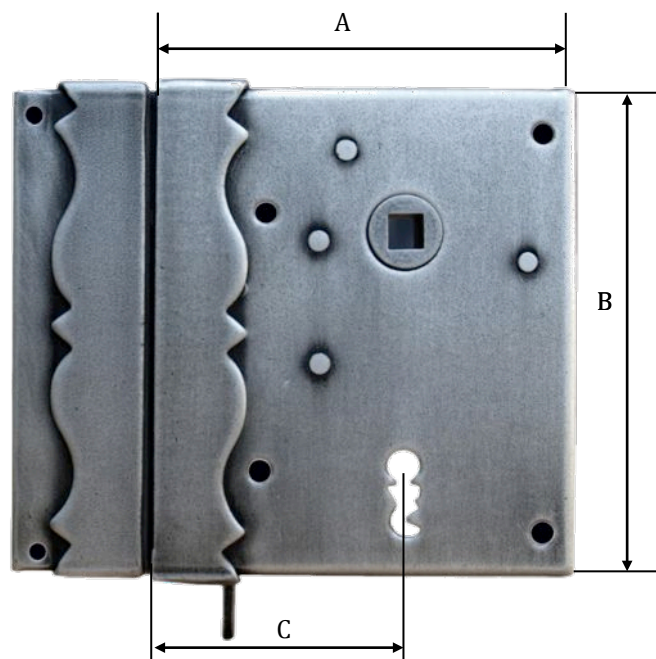

### Art. 5800/Dek

Serratura da applicare con decoro patent A 101 B 117 C 60  
Decorative rim lock key A 101 B 117 C 60

### Art. 5800Dek/Yale

Serratura da applicare con decoro yale A 101 B 117 C 60  
Decorative rim lock with cylinder hole A 101 B 117 C 60

### Art. 5820

Serratura da applicare patent A 125 B 138 C 75  
Rim lock key A 125 B 138 C 75

### Art. 5820/Yale

Serratura da applicare yale A 125 B 138 C 75  
Rim lock with cylinder hole A 125 B 138 C 75

### Art. 5820/Dek

Serratura da applicare con decoro patent A 125 B 138 C 75  
Decorative rim lock key A 125 B 138 C 75

### Art. 5820Dek/Yale

Serratura da applicare con decoro yale A 125 B 138 C 75  
Decorative rim lock with cylinder hole A 125 B 138 C 75

Le serrature sono fornite con 1 chiave standard, rosetta e bocchetta esterne e meccanismo "Made in Germany". Impugnatura e cilindro non sono compresi

*Rim-locks are supplied with 1 standard key, external rosette and escutcheon, "Made in Germany" mechanism.  
Levers and eurocylinder are not included*

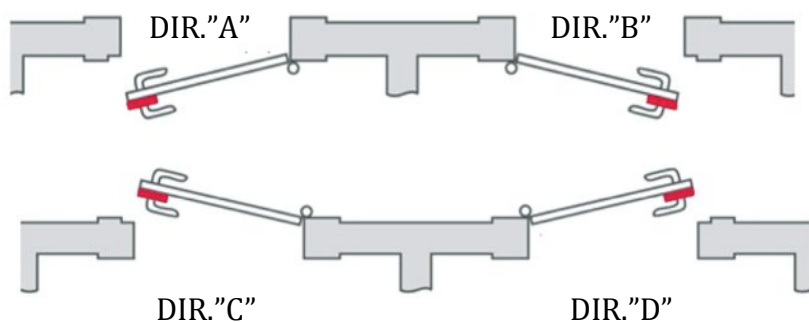

Serrature direzione "C" e "D" disponibili solo su ordinazione.  
"C" and "D" direction rim locks are available only on



Chiave standard  
Standard key



Chiave a richiesta  
Key on request



# Catenacci / Bolts

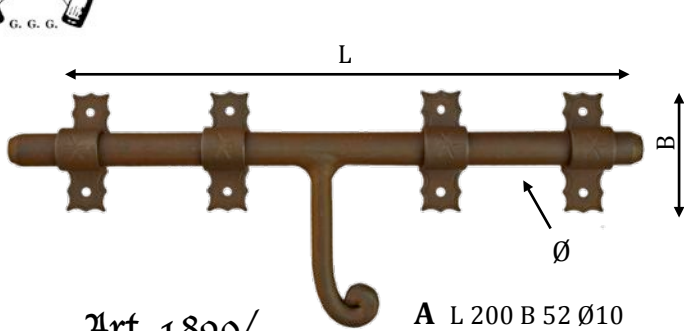

**Art. 1890/**  
Catenaccio  
Bolt

- A** L 200 B 52 Ø10
- B** L 250 B 56 Ø14
- C** L 300 B 62 Ø16
- D** L 400 B 80 Ø18

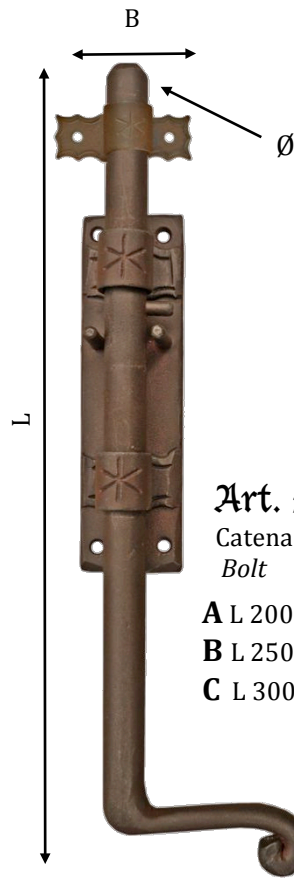

**Art. 1891/**  
Catenaccio  
Bolt

- A** L 200 B 30 Ø 10
- B** L 250 B 35 Ø 14
- C** L 300 B 40 Ø 16



A richiesta  
con ginocchio  
On Request  
cranked bolt

**Art. 1893/**  
Catenaccio  
Bolt

- A** L 250
- B** L 400
- C** L 500

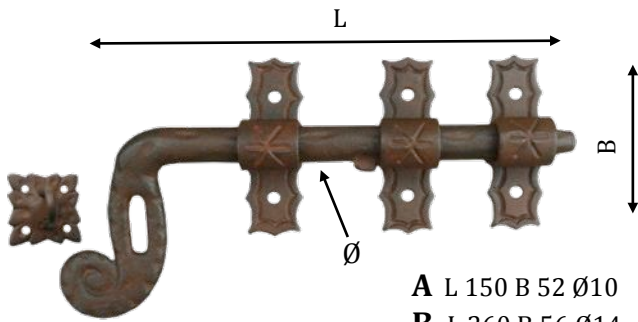

**Art. 1021/**  
Catenaccio portallucchetto  
Aldrop bolt

- A** L 150 B 52 Ø10
- B** L 260 B 56 Ø14
- C** L 350 B 62 Ø16
- D** L 450 B 80 Ø18

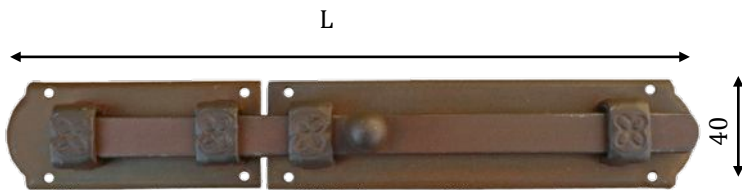

**Art. 1892/**  
Catenaccio Traverso  
Orizzontale Bolt

- A** L 220
- B** L 270
- C** L 370



**Art. 1894**

Catenaccio Traverso 115x40mm  
Orizzontale Bolt 115x40mm

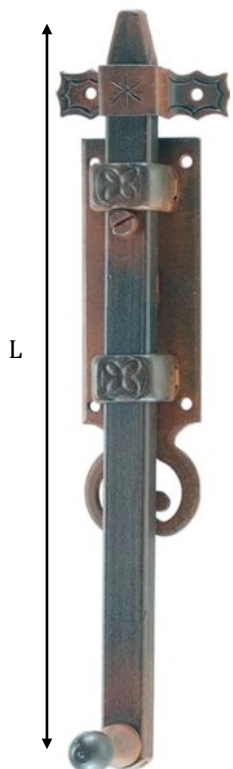

**Art. 2117/**  
Catenaccio Traverso  
Orizzontale Bolt

- A** L 250
- B** L 300

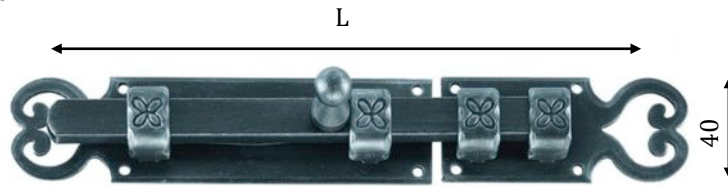

**Art. 2118/**  
Catenaccio Traverso  
Orizzontale Bolt

- A** L 250
- B** L 300

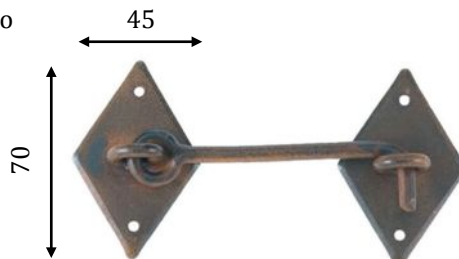

**Art. 2132/**

Chiavistello/Cabin hook  
A 145mm- Asta/Hook 100mm  
B 195mm- Asta/Hook 150mm

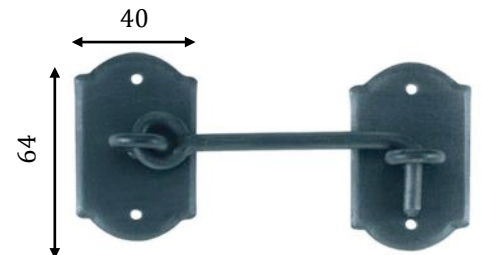

**Art. 2133/**

Chiavistello/Cabin hook  
A 145mm- Asta/Hook 100mm  
B 195mm- Asta/Hook 150mm



# Saltarelli & Chiavistelli

## Thumblatches & Latches



**Art.1711**  
Saltarello/Thumblatch  
Asta/Bar: 250 mm  
Placca/Backplate: 260X40mm



**Art.1712**  
Saltarello/Thumblatch  
Asta/Bar: 250 mm  
Placca/Backplate: 260X40mm

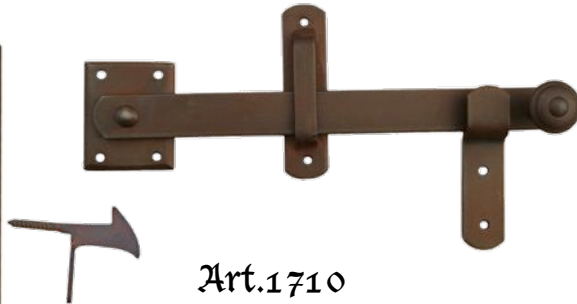

**Art.1710**  
Saltarello/Thumblatch  
Asta/Bar: 250 mm  
Placca/Backplate: 260X40mm



**Art.1720**  
Chiavistello con quadro 8mm  
Latch with spindle 8mm  
Asta / Bar: 190 mm



**Art.1714**  
Chiavistello/Latch  
Asta/Bar: 190 mm  
Rosetta/Rosette: 72X40mm



**Art.1713**  
Chiavistello/Latch  
Asta/Bar: 190 mm  
Rosetta/Rosette: 50X40mm



**Art.1715**  
Chiavistello/Latch  
Asta/Bar: 190 mm  
Rosetta/Rosette: 70X45mm



# Mottolini WC / Privacy Snibs

Quadri disponibili/Available spindle sizes: 5-6-7-8mm



Art.6-10/WC  
Rosetta/Rosette 72X40mm

Art.7-10/WC  
Rosetta/Rosette 64X40mm

Art.8-10/WC  
Rosetta/Rosette 70X45mm



Art.9-10/WC  
Rosetta/Rosette 66X30mm

Art.10-10/WC  
Rosetta/Rosette 60X40mm

Art.11-10/WC  
Rosetta/Rosette Ø 50mm



Art.12-10/WC  
Rosetta/Rosette 60X40mm



Art.14-10/WC  
Rosetta/Rosette 50X40mm

## Rosette Strette / Narrow rosettes

Dimensioni rosette/Rosette dimensions: 68X25X4mm

Rosette lisce / Flat rosettes

Rosette martellate / Hammered rosettes



Art.1086/R Art.1086/B Art.1086/C



Art.1085/R Art.1085/B Art.1085/C

# Cerniere / Hinges

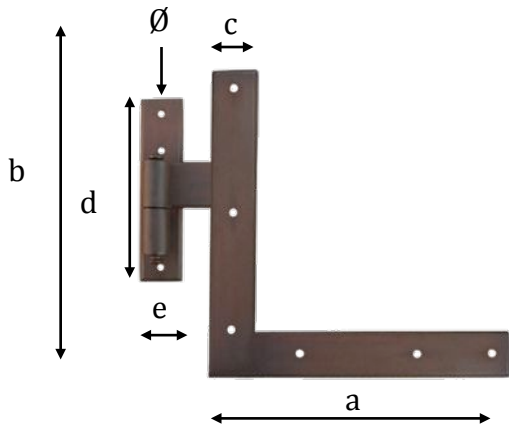

## Art.1752

Squadra con cardine - *Corner hinge with pivot*

1752/A: a 400 b 300 c 40 ≠5mm Ø14mm d 170 e 40 f 22  
 1752/B: a 600 b 400 c 40 ≠ 5mm Ø14mm d170 e 40 f 22

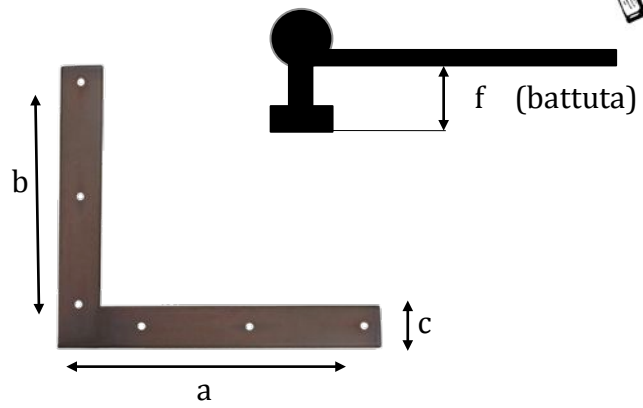

## Art.1752F

Squadra rinforzo - *Corner hinge*

1752F/A: a 400 b 300 c 40 ≠5mm  
 1752F/B: a 600 b 400 c 40 ≠ 5mm

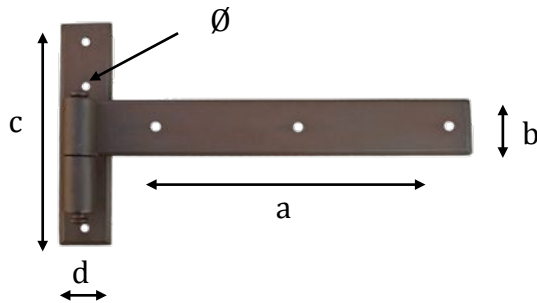

## Art.1750

Bandella con cardine - *Strap hinge with pivot*

1750/A: a 300 b 40 ≠5mm Ø14mm c 170 d 40 f22  
 1750/B: a 400 b 40 ≠ 5mm Ø14mm c 170 d 40 f22  
 1750/C: a 500 b 40 ≠ 5mm Ø14mm c 170 d 40 f22  
 1750/D: a 600 b 40 ≠ 5mm Ø14mm c 170 d 40 f22

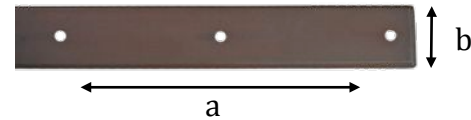

## Art.1751

Bandella finta- *False hinge*

Art 1751/A: a 275 b 40 ≠5mm  
 Art 1751/B: a 375 b 40 ≠ 5mm  
 Art 1751/C: a 475 b 40 ≠ 5mm  
 Art 1751/D: a 575 b 40 ≠ 5mm

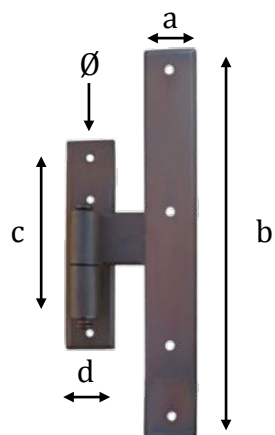

## Art.1753

Bandella a "T" con cardine  
*"T" hinge with pivot*

1753/A: a 40 b 300 ≠5mm c 170 d 40 Ø14 f22  
 1753/B: a 40 b 400 ≠ 5mm c 170 d 40 Ø14 f22

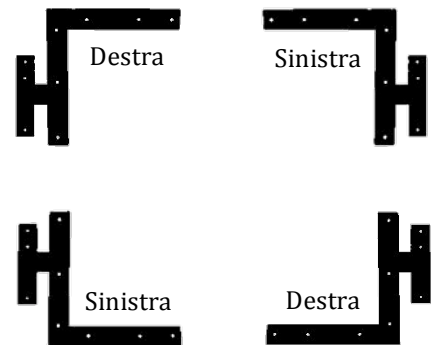

## Su richiesta / On request



## Art.515/14

Cardine a vite 12 MA x110  
 Perno sfilabile



## Art.1755

Cardine con piastra  
 larghezza 30mm  
*Pivot with straight  
 plate 30 mm.*



Cerniera con cardine a filo/ *Offset hinge*



# fasce per porte / Door kick plates

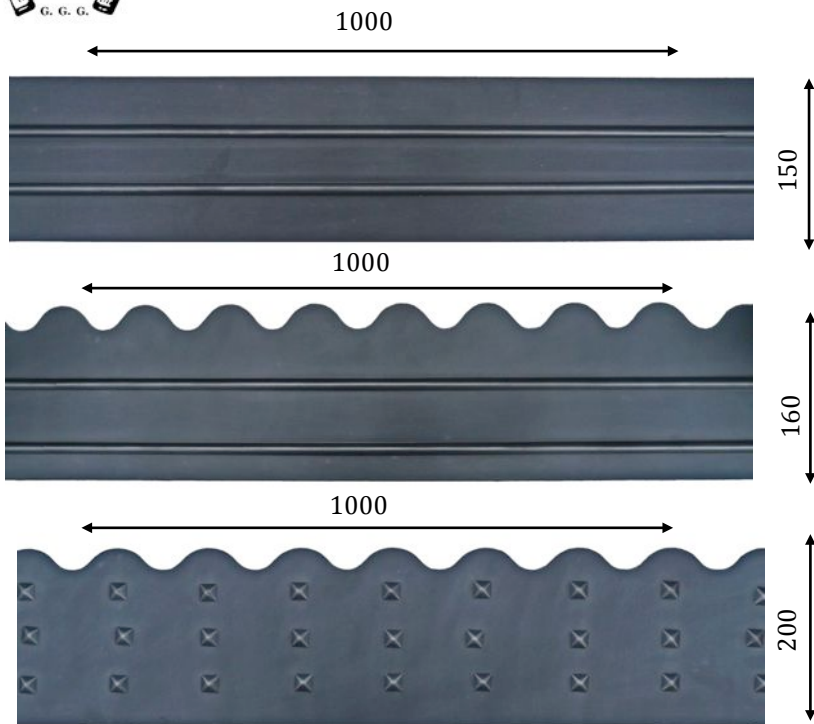

**Art.1850\***  
Fascia per porta  
Door kick plate

**Art.1851\***  
Fascia per porta  
Door kick plate

**Art.1852\***  
Fascia per porta  
Door kick plate

\* Su richiesta lunghezza modificata  
On request can be produced longer or shorter

# Supporti per Corrimano / Holder for Handrail



**Art.105/V**  
Rosetta: Ø 70mm  
Sporgenza: 80 mm  
Fissaggio a vite: M8x90mm  
Rosette: Ø 70mm  
Projection: 80 mm  
Screw fixing: M8x90mm



**Art.105**  
Rosetta: Ø 70mm  
Sporgenza: 80 mm  
Rosette: Ø 70mm  
Projection: 80 mm

# Copricerniere / Hinge Covers



**Art.400**  
**Art.400/14** Ø interno 14mm Altezza 98mm  
Ø internal 14mm Size 98mm  
**Art.400/15** Ø interno 15mm Altezza 104mm  
Ø internal 15mm Size 104mm  
**Art.400/16** Ø interno 16mm Altezza 110mm  
Ø internal 16mm Size 110mm



**Art.401**  
**Art.401/14** Ø interno 14mm Altezza 80mm  
Ø internal 14mm Size 80mm  
**Art.401/15** Ø interno 15mm Altezza 85mm  
Ø internal 15mm Size 85mm  
**Art.401/16** Ø interno 16mm Altezza 90mm  
Ø internal 16mm Size 90mm

# Appendiabiti & Grucce

## Coat Hooks & Hanger



Art.1731

Appendiabito/ Coat Hook 115x80mm  
Rosetta/ Rosette 72x40mm



Art.1732

Appendiabito/ Coat Hook 115x80mm  
Rosetta/ Rosette 72x45mm



Art.58

Appendiabito 120mm  
Coat Hook 120 mm



Art.789 + D...

Appendiabito/ Coat Hook 76mm  
Rosetta/ Rosette 72x40mm



Art.790 + D...

Appendiabito/ Coat Hook 50mm  
Rosetta/ Rosette 72x45mm



Art.56

Appendiabito 150mm  
Coat Hook 150mm



Art.57

Appendiabito 120mm  
Coat Hook 120mm



Art.791

Appendiabito/ Coat Hook  
Rosetta/ Rosette 66x30mm



Art.788

Appendiabito 76mm  
Coat Hook 76mm



Art.792

Appendiabito/ Coat Hook  
Piastra/ Plate



Art.1730

Gruccia appendiabito /Coat Hanger  
220x400mm ■ 8mm



Art.1729

Gruccia appendiabito /Coat Hanger  
220x400mm Ø 8mm

Art.1733/A

Appendiabito con ganci singoli /  
Coat Hook with single hooks  
490x260SP mm.

Art.1733/B

Con ganci doppi / with double hooks





# Numeri civici/ Civic Numbers



Art.200/0  
120mm



Art.200/1  
125mm



Art.200/2  
120mm



Art.200/3  
120mm



Art.200/4  
120mm



Art.200/5  
120mm



Art.200/6  
120mm



Art.200/7  
120mm



Art.200/8  
120mm



Art.200/9  
120mm



Art.200/A  
65mm



Art.200/B  
125mm



Art.200/C  
65mm

# Accessori Vari / Small accessories



Art.SQ  
Lucchetto  
Padlock

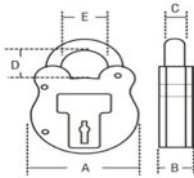

Art.SQ220 A38mm B14,5mm C7mm D11mm E12mm  
Art.SQ440 A51mm B16,5mm C8mm D18mm E18mm  
Art.SQ660 A64mm B19,7mm C10mm D21mm E21mm



Art.244  
Campanello 90X85mm  
Bell push 90X85mm



Art.242/  
Rosetta con campanello  
Door bell push  
A Ø50 mm  
B Ø60 mm  
C Ø78 mm



Art.243  
Campanello 64X40mm  
Bell push 64X40mm



Art. 250  
Catena di sicurezza per porta  
Security door chain  
Placca/Plate 140X40mm  
Rosetta/Rosette 64X40mm



Art.251  
Pomolo per cilindro 40mm - foro Ø 8 mm.  
Knob for cylinder 40 mm - hole Ø 8 mm.

# Placche Strette per Maniglie /

# Narrow handle backplates

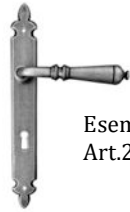

Esemplio/Example  
Art.2700/ST1



Esemplio/Example  
Art.2109/ST2



Esemplio/Example  
Art.2700/ST3

## Art. ST1

Placca 250x30mm  
Backplate 250x30mm

## Art. ST2

Placca 240x30mm  
Backplate 240x30mm

## Art. ST3

Placca 220x30mm  
Backplate 220x30mm

# Rosette e bocchette di Sicurezza / Security Rosettes



## Art.5030

Copia bocchette di sicurezza - foro yale  
Security rosettes set - eurocylinder hole  
Diametro/Diameter: 60 mm  
Spessore Rosetta Esterna: 12 mm  
Tickness External Rosette: 12 mm  
Spessore Rosetta Interna: 6 mm  
Tickness Internal Rosette: 6 mm



## Art.5005

Rosetta interna /Internal rosette  
Diametro/Diameter: 60mm  
Foro/Hole: Ø18mm

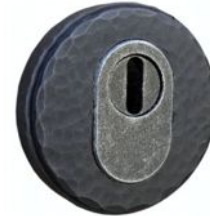

## Art.5040

Copia bocchette di sicurezza con defenfer  
Security rosettes set -with Defenfer  
Diametro/Diameter: 60 mm  
Spessore Rosetta Esterna: 12 mm  
Tickness External Rosette: 12 mm  
Spessore Rosetta Interna: 6 mm  
Tickness Internal Rosette: 6 mm



## Art.5010

Copia bocchette di sicurezza - foro yale  
Security rosettes set - eurocylinder hole  
Diametro/Diameter: 60 mm  
Spessore rosetta esterna: 12 mm  
Tickness external rosette: 12 mm  
Spessore rosetta interna: 6 mm  
Tickness internal rosette: 6 mm



## Art.5001

Rosetta interna /Internal rosette  
Diametro/Diameter: 60mm  
Foro/Hole: Ø18mm



## Art.5020

Copia bocchette di sicurezza con defenfer  
Security rosettes set -with Defenfer  
Diametro/Diameter: 60 mm  
Spessore rosetta esterna: 12 mm  
Tickness external rosette: 12 mm  
Spessore rosetta interna: 6 mm  
Tickness internal rosette: 6 mm



## Art.5044/DM

Rosetta martellata Ø50X2mm  
Hammered Rosette Ø50X2mm



## Art.5024/DM

Rosetta Ø50X2mm  
Rosette Ø50X2mm



# Maniglie di Sicurezza Classiche

## Classic Security Sets



**Placca Esterna: 250x55 mm, spessore 10 mm**  
 3 bussole filettate: 2 X M8 e 1 X M6.  
 Placca in acciaio temprato a protezione del cilindro

**Placca interna: 245 x 50 mm, spessore 3 mm**  
 fornita con 2 viti M8 e una vite M6  
 A richiesta con defender (**specificare: + DEF**)

**External plate: 250x55 mm, depth 10 mm**  
 invisible triple screwing: 2 X M8 e 1 X M6.  
 Hardened internal profile for eurocylinder

**Internal plate: 245 x 50 mm, depth 3 mm**  
 Supplied with 2 screws M8 e 1 screw M6

On request available with cylinder defender  
 (specify in the order: + DEF)



Placca  
 con Defender  
 Plate with cylinder  
 defender



Placca con pomolo  
 zancato  
 Plate with cranked  
 knob



Art.4350



Art.4351



Art.4352



Art.4353



Art.4354



Art.4355



Art.4356



Art.4357



Art.4358



Art.4359



Art.4360

Art.... : A=Pom. centrale-Man.SX B=Pom centrale-Man.DX C=Pom.zancato SX-Man.DX D= Pom.zancato DX-Man.SX E= Maniglia-Maniglia  
 Art.... : A=Knob/Left hand lever B=Knob/Right hand lever C=Cranked knob left/Right hand lever D= Cranked knob right/Left hand lever E= Lever/Lever



# Maniglie di Sicurezza Rustiche

## Rustic Security Sets



**Placca Esterna: 250x55 mm, spessore 10 mm**  
 3 bussole filettate: 2 X M8 e 1 X M6.  
 Placca in acciaio temprato a protezione del cilindro

**Placca interna: 245 x 50 mm, spessore 3 mm**  
 fornita con 2 viti M8 e una vite M6  
 A richiesta con defender (**specificare: + DEF**)

**External plate: 250x55 mm, depth 10 mm**  
 invisible triple screwing: 2 X M8 e 1 X M6.  
 Hardened internal profile for eurocylinder

**Internal plate: 245 x 50 mm, depth 3 mm**  
 Supplied with 2 screws M8 e 1 screw M6

On request available with cylinder defender  
 (specify in the order: + DEF)



Placca  
 con Defender  
 Plate with cylinder  
 defender



Placca con pomolo  
 zancato  
 Plate with cranked  
 knob



Art.4300

Art.4301

Art.4302

Art.4303



Art.4304



Art.4305



Art.4306



Art.4307



Art.4309



Art.4310



Art.4311

Art.... : A=Pom. centrale-Man.SX B=Pom centrale-Man.DX C=Pom.zancato SX-Man.DX D= Pom.zancato DX-Man.SX E= Maniglia-Maniglia  
 Art.... : A=Knob/Left hand lever B=Knob/Right hand lever C=Cranked knob left/Right hand lever D= Cranked knob right/Left hand lever E= Lever/Lever



# Maniglie di Sicurezza su Rosetta

## Security Sets on Rosettes

**Rosetta esterna:** Ø60X12mm spessore, fornita con 2 bussole filettate M5 e a richiesta con defender  
**Placca Interna:** Ø60X6mm spessore, fornita con 2 viti M5X70mm

**External rosette:** Ø60X12mm width, invisible double screwing  
**Internal rosette:** Ø60X 6mm width, supplied with 2 screws M5X70mm

*On request available with cylinder defender*

Rosetta con defender  
 Rosette with cylinder defender



Art.5350



Art.5351



Art.5352



Art.5353



Art.5354



Art.5355



Art.5356

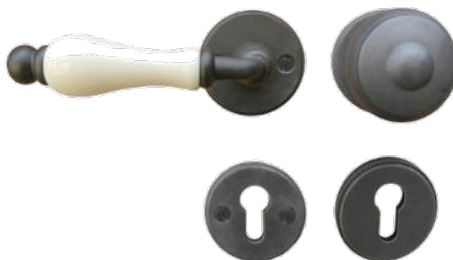

Art.5357+D...



Art.5358



Art.5360



Art.5300



Art.5301



Art.5305



Art.5307



Art.5311

**Art.... :** A=Pom. centrale-Man.SX B=Pom centrale-Man.DX C=Pom.zancato SX-Man.DX D= Pom.zancato DX-Man.SX E= Maniglia-Maniglia  
**Art.... :** A=Knob/Left hand lever B=Knob/Right hand lever C=Cranked knob left/Right hand lever D= Cranked knob right/Left hand lever E= Lever/Lever

# Maniglie di Sicurezza con placca Hardox® Security door handles with hardox backplate®

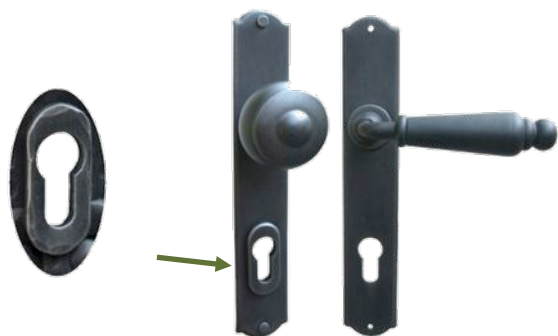

**Placca Est.:** Fornita con bussole filettate 2 xM5 e placca in acciaio a protezione del cilindro

**Placca Interna:** Fornita con 2 viti M5

*External plate:* invisible double screwing with M5 screws and hardened outside profile for cylinder

*Internal plate:* fixation with 2 screws M5



Art.4367



Art.4361



Art.4362



Art.4363 +D...



Art.4364



Art.4365



Art.4366



Art.4320



Art.4321



Art.4322



Art.4323



Art.4324



Art.4326



Art.4325



Art.4328

Art.... : A=Pom. centrale-Man.SX B=Pom centrale-Man.DX C=Pom.zancato SX-Man.DX D= Pom.zancato DX-Man.SX E= Maniglia-Maniglia  
Art.... : A=Knob/Left hand lever B=Knob/Right hand lever C=Cranked knob left/Right hand lever D= Cranked knob right/Left hand lever E= Lever/Lever



# Maniglie per mobili / Furniture Handles



**Art.045**  
110mm-Rosette: Ø35mm  
110mm-Rosettes: Ø35mm



**Art.5-70+D6**  
112X55mm



**Art.060/A** 92mm  
**Art.060/B** 105mm



**Art.053**  
100X55mm Sporgenza  
100X55mm Projection



**Art.054**  
100X55mm Sporgenza  
100X55mm Projection



**Art.055**  
100X55mm Sporgenza  
100X55mm Projection



**Art.046/A**  
115mm-Rosette: Ø35mm  
115mm-Rosettes: Ø35mm

**Art.046/B**  
192mm-Rosette: Ø35mm  
192mm-Rosettes: Ø35mm



**Art.039/A** 45mm Ros.35mm  
**Art.039/B** 55mm Ros.35mm  
**Art.039/C** 65mm Ros35mm



**Art.047/A**  
85mm-Rosette: Ø35mm  
85mm-Rosettes: Ø35mm

**Art.047/B**  
120mm-Rosette: Ø35mm  
120mm-Rosettes: Ø35mm



**Art.028/A**  
Anello-Ring Ø35mm  
Rosetta-Rosette 70x45mm  
**Art.028/B**  
Anello-Ring Ø40mm -  
Rosetta-Rosette 70x45mm

**Vert./Oriz. Reversibile**  
**Vert./Oriz. Reversibile**



**Art.038**  
Anello-Ring 42x45mm  
Rosetta-Rosette 66x30mm

**Vert./Oriz. Reversibile**  
**Vert./Oriz. Reversibile**



**Art.033/A**  
Anello-Ring Ø35mm  
Rosetta/Rosette 85x35mm  
**Art.033/B**  
Anello-Ring Ø40mm  
Rosetta-Rosette 85x35mm

**Vert./Oriz. Reversibile**  
**Vert./Oriz. Reversibile**



**Art.057/A**  
Anello-Ring Ø35mm  
Rosetta-Rosette 72x40mm  
**Art.057/B**  
Anello-Ring Ø40mm  
Rosetta-Rosette 72x40mm

**Vert./Oriz. Reversibile**  
**Vert./Oriz. Reversibile**

# Accessori per mobili / Furniture accessories



**Art.034/A**  
Anello / Ring Ø42mm  
Rosetta / Rosette Ø35mm  
**Art.034**  
Solo anello / Only ring  
Ø42mm



**Art.036/A**  
Anello / Ring 42x45 mm  
Rosetta / Rosette Ø35mm  
**Art.036**  
Solo anello / Only ring  
42x45mm



**Art.025/A**  
Anello / Ring Ø35mm -  
Rosetta / Rosette Ø35mm  
**Art.025**  
Solo anello / Only ring Ø35mm  
**Art.026/A**  
Anello / Ring Ø40mm -  
Rosetta / Rosette Ø35mm  
**Art.026**  
Solo anello / Only ring Ø40mm



**Art.029/A**  
Anello / Ring Ø35mm -  
Rosetta / Rosette Ø35mm  
**Art.029**  
Solo anello / Only ring Ø35mm  
**Art.030/A**  
Anello / Ring Ø40mm -  
Rosetta / Rosette Ø35mm  
**Art.030**  
Solo anello / Only ring Ø40mm



**Art.041**  
Ø42mm



**Art.040**  
Ø35mm



**Art.061**  
42X36mm



**Art.043/A** Ø25mm  
**Art.043/B** Ø30mm  
**Art.043/C** Ø35mm



**Art.042/A**  
Ø30mm  
Rosetta / Rosette: Ø35mm  
**Art.042**  
Solo pomolo / only knob  
Ø30mm



**Art.059/A** 27x27mm  
**Art.059/B** 35x35 mm  
**Art.059/C** 40x40 mm.



**Art.035/A** 60mm -  
Rosetta / Rosette Ø35mm



**Art.044**  
Ø25mm



**Art.058/B**  
85X40mm



**Art.058/A**  
40X85mm



**Art.050/B**  
72X40mm



**Art.050/A**  
40X72mm



**Art.051/B**  
70X45mm



**Art.051/A**  
45X70mm



**Art.052/B**  
66X30mm



**Art.052/A**  
30X66mm



# Pomoli Porcellana "Babarìa" Knobs "Babarìa" Porcelains



☞ Art. 01

Pomolo Ø25 mm - Rosetta Ø35 mm - Vite M4  
Knob Ø25 mm - Rosette Ø35 mm - Screw M4



☞ Art. 02

Pomolo Ø30 mm - Rosetta Ø40 mm - Vite M4  
Knob Ø30 mm - Rosette Ø40 mm - Screw M4



☞ Art. 03

Pomolo ovale 43x27 mm - Rosetta Ø40 mm - Vite M4  
Oval knob 43x27 mm - Rosette Ø40 mm - Screw M4



☞ Art. 04

Pomolo Ø25 mm - Rosetta 72x40 mm - Vite M4  
Knob Ø25 mm - Rosette 72x40 mm - Screw M4



☞ Art. 05

Pomolo Ø30 mm - Rosetta 72x40 mm - Vite M4  
Knob Ø30 mm - Rosette 72x40 mm - Screw M4



☞ Art. 06

Pomolo ovale 43x27 mm - Rosetta 72x40 mm - Vite M4  
Oval knob 43x27 mm - Rosette 72x40 mm - Screw M4



☞ Art. 07

Pomolo Ø25 mm - Rosetta 70x45 mm - Vite M4  
Knob Ø25 mm - Rosette 70x45 mm - Screw M4



☞ Art. 08

Pomolo Ø30 mm - Rosetta 70x45 mm - Vite M4  
Knob Ø30 mm - Rosette 70x45 mm - Screw M4



☞ Art. 09

Pomolo ovale 43x27 mm - Rosetta 70x45 mm - Vite M4  
Oval knob 43x27 mm - Rosette 70x45 mm - Screw M4

## Avorio con fiori "Primavera" Ivory with flowers "Spring"



☞ Art. D30



☞ Art. D31



☞ Art. D32

## Avorio Craquelè Crackled Ivory



☞ Art. D33



☞ Art. D34



☞ Art. D35

## Avorio Ivory



☞ Art. D36



☞ Art. D37



☞ Art. D38

## Bianco White



☞ Art. D39



☞ Art. D40



☞ Art. D41

# Pannelli espositori / Advertising display boards



## **Pannello a due lati con ruote**

Misure: 180x50 cm.

Base: 55x35 cm.

## ***Two sides display board with wheels***

*Measures: 180x50 cm.*

*Basement: 55x35 cm.*



## **Pannello a muro**

Misure: 140x62 cm.

## ***Hang display board***

*Measures: 140x62 cm.*



## **Pannello a muro**

Misure:  
90x60 cm.  
70x50 cm.  
60x50 cm.  
50x40 cm.  
40x30 cm.

## ***Hang display board***

*Measures:  
90x60 cm.  
70x50 cm.  
60x50 cm.  
50x40 cm.  
40x30 cm.*

# Le nostre finiture – Finishes



**Nero Antico NA**  
*Antique Black NA*



**STRONG BLACK®**



**Antichizzato Ruggine AR**  
*Antique Rust AR*



**Silver Zinc**  
*Silver Zinc (Pewter)*



**Nero Zincato Z**  
*Zinc-plated Z*



**Nero Bronzato**  
*Bronze Black*



**Grigio Ferro Ant. GFA**  
*Antique Grey Iron GFA*



**Nero Ramato**  
*Copper Black*



**Bianco-Oro Antich.**  
*Ant. Gold-White*



**Verde-Oro Antich**  
*Ant. Gold-Green*



**Blu-Oro Antich**  
*Ant. Gold-Blue*



**Rosso-Oro Antich.**  
*Ant. Gold-Red*



**Grigio Ferro Chiaro GF**  
*Light Grey GF*



**Oro Antico**  
*Antique Gold*

Finitura tipo "NA" nero antico: ferro sabbiato, verniciato nero a forno e antichizzato.

Finitura tipo "Strong Black": ferro sabbiato, zincato, verniciato nero a forno e antichizzato.

Finitura tipo "Z" zincato e antichizzato nero: ferro sabbiato, zincato, verniciato nero a forno e spazzolato.

Finiture tipo "Silver Zinc": Ferro sabbiato, zincato e antichizzato.

Finitura tipo "A.R." antichizzato ruggine. Essendo un procedimento naturale può variare da una fornitura all'altra.

Finitura tipo "G.F." grigio ferro chiaro: ferro sabbiato, verniciato metallizzato.

Finitura tipo "G.F.A." grigio ferro antichizzato: ferro sabbiato, verniciato e spazzolato.

Finiture Verde oro antichizzato, rosso oro antichizzato, nero bronzato (nero oro), nero ramato (nero rame), blu antichizzato, bianco oro antichizzato, oro antico (non sfumato): Ferro sabbiato, verniciato e sfumato a mano con polvere oro o rame.

Le finiture speciali essendo fatte su specifica ordinazione possono comportare tempi di consegna più lunghi ( minimo 15 giorni).

Qualora nelle ordinazioni non risulti espressamente specificata la finitura, le merce sarà da noi sempre consegnata con finitura standard Nero Antico.

*Finish "NA" antique black. Sandblasted iron, black matt, antiqued.*

*Finish "Strong Black": Sandblasted iron, zinc-plated, black matt and antiqued.*

*Finish "Z" zinc-plated and antique black. Sandblasted iron, zinc-plated and brushed.*

*Finish Silver Zinc - zinc-plated and antiqued.*

*Finish "A.R." antique rust. Is obtained through a natural process and supplies may differ accordingly.*

*Finish "G.F." light grey. Sandblasted iron coloured.*

*Finish "G.F.A." antique grey iron. Sandblasted iron, coloured and brushed.*

*Finishes antique gold green, antique gold red, bronze black, copper black, antique blue, antique gold white, antique gold - sandblasted iron, coloured and shaded by hand.*

*Please note that for special finishes delivery time can be longer (minimum 15 days).*

*If finish is not expressly specified in the orders, goods will be delivered by us in Antique Black finish.*



# Porcellane "Bavaria" - "Bavaria" porcelains



Art. D5  
Avorio Craquelè - *Crackled Ivory*



Art. D6



Art. D1  
Avorio "Fiori di Pesco" - *Ivory with "Peach-Blossom"*



Art. D2



Art. D9  
Avorio - *Ivory*



Art. D10



Art. D20  
Bianco con "Fiori Blu" - *White with "Blue Flowers"*



Art. D21



Art. D13  
Bianco - *White*



Art. D14



Art. D22  
Avorio con fiori "Primavera" - *Ivory with flowers "Spring"*



Art. D23



## PORCELLANA ORIGINALE BAVARESE ORIGINAL BAVARIAN PORCELAIN

Le impugnature *craquelè* essendo realizzate con metodo artigianale possono variare nella concentrazione delle screpolature.  
*Crackled porcelains are produced using handicraft method and can vary in the concentration of cracks*

### FORATURE - KEY HOLES:

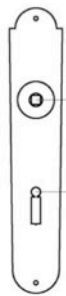

Patent - BB Hole	
Italia	70/90 mm.
Germany	72 mm.
Switzerland	78 mm.
Austria	90 mm.
France	70 mm.
Russia	90 mm.
Greece	75/90 mm.
UK -Ireland	57 mm.



Yale - Euro Cylinder	
Italia	85 mm.
Germany	92/72 mm.
Switzerland	78 mm.
Austria	88 mm.
France	70 mm.
Russia	85 mm.
Greece	85 mm.
UK -Ireland	57 mm.



WC	
Italia	70/90 mm.
Germany	78 mm.
Switzerland	78 mm.
Austria	90 mm.
France	70 mm.
Russia	70/90 mm.
UK -Ireland	57 mm.

### APERTURA PORTA DESTRA/SINISTRA - LEFT/RIGHT HAND

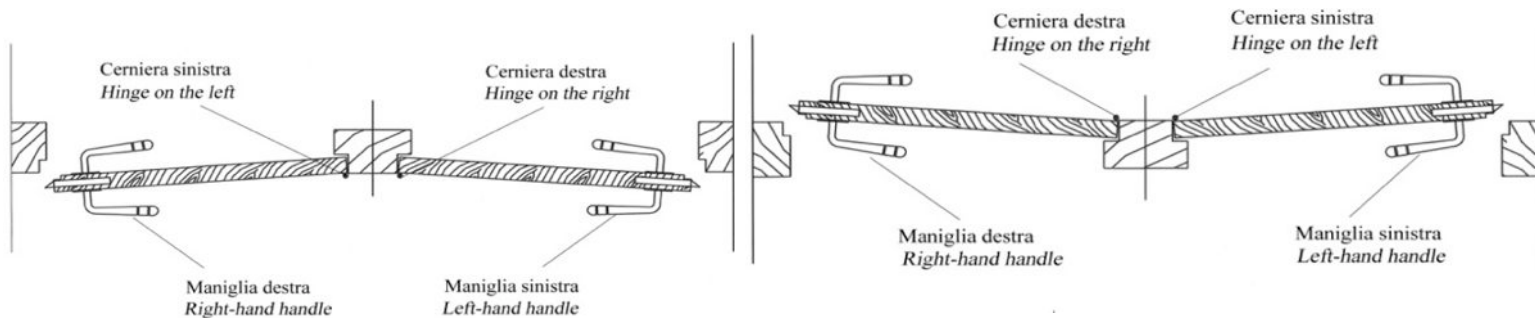



### Condizioni di vendita

1) La nostra Società si riserva il diritto di accettare o rifiutare qualsiasi ordinazione, anche assunta a mezzo di nostri Agenti e Rappresentanti.

2) La nostra Società si riserva il diritto di escludere qualsiasi articolo dalla produzione o di apportare modifiche, senza preavviso, quando ciò si rende necessario per cause di forza maggiore, impreviste esigenze costruttive o per migliorare la qualità degli articoli stessi.

3) La merce viaggia a rischio e pericolo del Committente. Non si assume alcuna responsabilità per furti, manomissioni, avarie, che si dovessero verificare durante il trasporto.

4) Il trasporto sia a mezzo corriere o servizio postale è sempre a carico dell'Acquirente.

5) La nostra società accetta eventuali reclami unicamente se fatti entro 8 giorni dal ricevimento della merce.

6) Eventuali resi di merci devono essere effettuati esclusivamente dopo nostra autorizzazione con le modalità che vi saranno comunicate al momento della richiesta del reso, comunque sempre franco di ogni spesa ai nostri magazzini.

7) Tutti i resi non difettosi verranno da noi ritirati entro 30 giorni dalla data d'acquisto, previa autorizzazione, con l'addebito al cliente del 30% per rimagazzinaggio e riconfezionamento. Non si accettano resi degli articoli non a catalogo o prodotti su specifica richiesta privi di difetti.

8) I termini stabiliti per le consegne hanno solo carattere indicativo. In ogni caso qualsiasi indennità di ritardata consegna o l'annullamento dell'ordine stesso non potrà mai essere preteso dall'Acquirente.

9) I pagamenti devono essere effettuati presso il domicilio della nostra società: 23868 Valmadrera, via Verdi 10 oppure sul nostro conto bancario: Deutsche Bank s.p.a. filiale Valmadrera, c/c 000000018400 ABI:03104 CAB:51810 SWIFT:DEUTITM1028 CIN:"D" IBAN:IT31D0310451810000000018400

10) Il mancato pagamento anche parziale ci autorizza a sospendere ulteriori invii di merce.

11) Per i ritardi sul pagamento convenuto all'ordinazione saranno conteggiati gli interessi bancari vigenti.

12) Per ogni controversia l'Acquirente riconosce unico foro competente in via esclusiva quello giudiziario di Lecco.

13) Non riconosciamo le condizioni di acquisto degli Acquirenti quando sono in contrasto con le nostre Condizioni di Vendita, a meno che non siano esplicitamente accettate.

14) Qualsiasi difetto o vizio, occulto od apparente, e qualsiasi difformità della merce e materiali venduti fatto salvo il punto 2, daranno all'Acquirente il solo diritto di richiedere la sostituzione, con esclusione assoluta di ogni nostra ipotetica responsabilità per rivalsa di danni diretti e indiretti: in ogni modo questo diritto alla sostituzione dovrà essere esercitato nel termine massimo di 1 mese dalla consegna.

**L'Acquirente confermando alla nostra Società un'ordinazione di merce approva e accetta le nostre condizioni di vendita di cui ha preso integrale conoscenza.**

### Terms and conditions of sale

1) Galbusera reserves the right to accept or to refuse any order even if received through their agents or representatives.

2) Galbusera reserves the right to modify characteristics of the items shown and described in the catalogue, without notice, if this is required for unexpected construction requirements or to improve quality of items themselves.

3) Goods travel at Customer's risk and peril. No responsibility will be taken for any theft, tampering or damage during transit.

4) Transport by carrier or by post is always borne by Customer.

5) All claims must be reported within 8 days from receipt of the shipment.

6) Returns of goods are accepted when authorized by Galbusera according to the conditions that will be notified upon the request of return, in any case ex our warehouse.

7) Any defect, hidden or apparent, of goods and materials sold (except point n. 2), will give to the Customer only the right to require the replacement, with absolute exclusion of our hypothetical liability for compensation of any direct and indirect damages: in any case this right to the replacement must be exercised within a maximum period of 1 month of purchase.

8) Galbusera will accept all non defective returns within 30 days of purchase with the charge to the customer of 30% for re-storage and re-packaging and in any case after Galbusera's official authorization. Special items cannot be returned.

9) Delivery dates are indicative and no liability is accepted for any unforeseen delays or for any consequential loss or damage caused to the customer or third parties as a result of any delays for whatever reason.

10) Payment: the balance due will be paid to our company: 23868 Valmadrera, via Verdi 10 or by bank transfer to : Deutsche Bank s.p.a. branch of Valmadrera, account n. 000000018400 SWIFT:DEUTITM1028 - IBAN: IT31D0310451810000000018400

11) If payment - even partial - is not received, Galbusera will be authorized to stop further shipments of goods.

12) If payment is not received during the time agreed upon, the payment will be subject to bank interests.

13) Any dispute relating to or however in connection with the contracts governed by these general conditions shall be settled by the -court of - Lecco / Italy as the exclusive competent Jurisdiction.

14) Galbusera doesn't not recognize the Terms and Conditions of Purchase of the Customer when they are in conflict with our Terms and Conditions of Sale, unless they are explicitly accepted by both parties.

**Customer automatically accepts these Terms & Conditions when confirming purchase order to Galbusera.**



# Galbusera

**GALBUSERA GIANCARLO & GIORGIO SNC**

VIA G. VERDI 10

23868 VALMADRERA (LC) ITALIA

T: + 39 0341 58.12.84

F: + 39 0341 20.10.68

E: MAIL@GALBUSERAGG.IT

W: WWW.GALBUSERAGG.IT

WWW.ANTIKBESCHLAEGE.BIZ



Rivenditore autorizzato/ Official dealer: