



G. G. G.

Galbusera

FERRO BATTUTO D'ARTE



CATALOGO FERRAMENTA ARTISTICA



Galbusera Giancarlo & Giorgio snc

Premiata fabbrica ferro battuto d'arte = ferramenta artistica

SEDE – HEAD OFFICE

23868 VALMADRERA (LC) – ITALY

VIA G. VERDI 10

T: +39 (0)341 58.12.84 F: +39 (0)341 20.10.68

E: MAIL@GALBUSERAGG.IT

W: WWW.GALBUSERAGG.IT

PARTITA IVA E CODICE FISCALE: IT 00205480130

PRODUZIONE-PRODUCTION

23868 VALMADRERA (LC) VIA G. VERDI 10

23862 CIVATE (LC) VIA SAN PAOLO 1

FONDATA NEL 1925

SINCE 1925



Premio Qualità
Quality Award



Albo d'oro del Lavoro
Business Gold Award

INDICE GENERALE

- | | | | |
|--|---------------|--|------------------|
| - Anelli con pinza per scorritenda | pag. 56 57 58 | - Maniglie su placca massicce | |
| - Aste, bastoni per scorritenda | pag. 56 57 | con molla richiamo per porte e portoni | pag. 11 |
| - Aste per composizioni ornamentali | pag. 63 | - Maniglie per toilette | pag. 10 |
| - Attaccapanni, ganci | pag. 50 | - Maniglie su rosetta con bocchetta | |
| | | per porte | pag. 12 |
| - Bandelle, a "T", a "T" doppie, per porte, | pag. 30 31 32 | - Maniglie a gruccia con nottolino per usci | pag. 12 |
| portoni, finestre, imposte | 33 34 35 | - Maniglie per finestre | pag. 16 17 18 |
| - Bandelle a squadra, per porte, | | - Maniglie per mobili | pag. 47 |
| portoni, finestre, imposte | pag. 36 37 38 | - Maniglioni, diritti, zancati, a ricciolo | pag. 22 |
| - Battenti per porte e portoni | pag. 20 21 22 | - Martelline per finestre | pag. 16 17 |
| - Blocca imposte con fermo di sicurezza | pag. 23 | - Martelline, movimento Dry Keep | pag. 18 |
| - Blocca imposte a raggiera | pag. 28 | - Mensole, piane, con gancio | pag. 52 53 |
| - Bocchette per mobili | pag. 48 | - Motivi per composizioni ornamentali | pag. 63 |
| - Bocchette foro normale e Yale per porte | pag. 15 | | |
| - Borchie copridado | pag. 49 | - Numeri civici | pag. 62 |
| - Buche per lettere con portanome | pag. 62 | | |
| - Buche per lettere con portanome | | - Paletti per chiusura battenti | pag. 23 |
| e pulsante campanello | pag. 51 62 | - Pannelli per composizioni ornamentali | pag. 63 |
| | | - Paumelle, piane, piegate alla francese | |
| - Campanelli elettrici "Pulsante su rosetta" | pag. 51 62 | per porte e finestre | pag. 42 |
| - Cantonale di rinforzo per mobili | pag. 46 | - Pendenti su rosetta con vite passante | |
| - Cardini a legno, per bandelle, | | per mobili | pag. 48 |
| cerniere a squadra per porte e finestre | pag. 39 | - Pomoli su placca fissi o girevoli per porte | pag. 13 |
| - Cariglioni per finestre gioco MP/Gratz | pag. 16 17 | - Pomoli su rosetta, fissi o girevoli, per porte | pag. 14 |
| - Cassette lettere a muro | | - Pomoli fissi su piastra zancata | pag. 14 |
| a piantana con portapane | pag. 59 60 61 | - Pomoli su rosetta, con vite passante | |
| - Catena | pag. 54 | per mobili | pag. 48 49 |
| - Catena di sicurezza per porta | pag. 23 | - Porta giornali a muro | pag. 61 |
| - Catenacci a coda, a traverso | | | |
| con portalucchetto | pag. 24 25 | - Ramponi, spranghe per battenti | pag. 23 |
| - Cavallotti a rullo | pag. 23 | - Reggicordone a muro | |
| - Cerniere, doppie, finte, a vite | | (per cordoni \varnothing 25 mm) | pag. 58 |
| per porte e finestre | pag. 40 41 42 | - Riloghe | pag. 55 56 57 58 |
| - Cerniere per mobili e cassapanche | pag. 44 45 46 | - Rosette per composizione maniglie | pag. 15 |
| - Chiavistelli | pag. 23 | | |
| - Chiodi ad una e due punte | pag. 49 | - Spagnolette per porte e finestre | pag. 28 |
| - Citofono "Tetto protezione intemperie" | pag. 62 | - Scorritenda, movimento a strappo | pag. 55 56 57 58 |
| - Copriavvolgibile per tapparelle | pag. 58 | - Scorritenda anelli con pinza | pag. 56 57 58 |
| - Coprinterruttori | pag. 51 | - Scorritenda, aste, bastoni | pag. 56 57 |
| - Cremonesi con o senza movimento | pag. 16 17 18 | - Scorritenda supporto centrale | pag. 56 57 |
| | | - Scorritenda supporti laterali con finale | pag. 55 56 57 |
| - Elementi per composizioni ornamentali | pag. 63 | - Squadre di rinforzo per porte, | |
| - Fermapersiane, a murare, a vite, | | portoni e finestre | pag. 30 31 32 |
| con piastra legno | pag. 26 27 | | 33 34 35 |
| - Foglie per composizioni ornamentali | pag. 63 | | 36 37 38 |
| | | - Squadretta di rinforzo per mobili | pag. 46 |
| - Ganci attaccapanni, a vite | | | |
| su rosetta, universali | pag. 50 54 | - Teste per chiavi | pag. 49 |
| | | | |
| - Maniglie su placca per porte | pag. 6 7 8 | - Zanche a murare per bandelle, | |
| | 9 10 | cerniere a squadra per porte e finestre | pag. 39 |



- **MANIGLIE PER PORTE, PORTONI, IMPOSTE, FINESTRE**
Pomoli, rosette, bocchette, martelline, cremonesi M P., GRATZ, DK
- **GUARNITURE PER PORTE, PORTONI, IMPOSTE, FINESTRE**
Battenti, maniglioni, chiavistelli, catenacci, paletti, ramponi, cavallotti a rullo, fermapersiane, ferma imposte a raggiera, spagnolette
- **BANDELLE, CANTONALI E CERNIERE PER PORTE, PORTONI, IMPOSTE, FINESTRE**
Bandelle con cardine diritte, doppie, a squadra, a T, a doppio T,
Squadre di rinforzo, cardini a legno, a vite, zanche a murare, cerniere
- **GUARNITURE PER MOBILI, ACCESSORI PER ARREDAMENTO , ATTACCAPANNI**
Cerniere, cerniere portalucchetto, per cassapanche, maniglie, pendenti, pomoli, bocchette, teste per chiavi, borchie, appendiabiti, coprinterruttori, targhe portanome, rosette con campanello, buche per lettere, mensole piane, a gancio, catene , ganci
- **RILOGHE SCORRITENDA, ACCESSORI PER TENDE**
Reggicordoni, piastre copriavvolgibili
- **CASSETTE E BUCHE PER LETTERE, NUMERI CIVICI, PARTICOLARI PER
COMPOSIZIONI ORNAMENTALI IN FERRO BATTUTO**
Pulsanti campanello, pannelli, riccioli, foglie, barre, aste, motivi ornamentali

Tutti gli articoli illustrati e descritti in catalogo, sono costruiti in ferro forgiato e battuto, e sono disponibili in due differenti finiture:

- Finitura tipo 'N' - Normale. Ferro sabbiato, verniciato in nero opaco, antichizzato.
- Finitura tipo 'Z' - Zincata, garantita contro la ruggine. Ferro sabbiato, zincato, verniciato in nero opaco, antichizzato. Solo per articoli quotati in listino alla colonna prezzo 'Z' Zincato.

N.B. Qualora nelle ordinazioni non risulti espressamente specificato il tipo di finitura richiesto, la merce sarà da noi sempre consegnata con la finitura di tipo 'N' Normale.

Condizioni di vendita , vedi pag. 64.



Galbusera produce:

FERRO BATTUTO D'ARTE

Servizi ed attrezzi per camino, alari, parascintille, portalegna, catene per camino, piastre per camini in ghisa, poggiapentole, pentole e rulli per castagne.

Spiedi girarrosti per esterni e interni, griglie per cucinare.

Campane per ingressi, banderuole segnamento, cassette per lettere a muro, a piantana, buche per lettere.

Portabottiglie, portariviste, portachiavi, portacenere, oggetti decorativi, candelieri, articoli da regalo.

Specchiere e consolle, attaccapanni, ganci appendiabiti, portaombrelli, mensole, fioriere, portafiori.

Illuminazione: lampadari, appliques, lampade, lampioni, lanterne a braccio e a catena.
Letti, testate per letto, riloghe scorritenda.

FERRAMENTA ARTISTICA IN FERRO FORGIATO E BATTUTO

Maniglie per porte, martelline e cremonesi per finestre, cerniere, paumelles per porte e finestre, maniglioni, battenti, pomoli, chiavistelli, catenacci, paletti, spranghe, bandelle, cantonali (squadre rinforzo), spagnolette, fermapersiane, chiodi, borchie copridado, teste per chiavi, coprinterruttori, targhe e buche per lettere con campanello, mensole piane a gancio, ganci universali e appendiabiti, catene.

Maniglie, cerniere, pomoli, pendenti, bocchette, decorazioni per guarnizioni mobili.

Riloghe e accessori scorritenda, piastre copriavvolgibili, reggicordoni.

Pannelli, elementi, particolari, foglie, aste, barre in ferro grezzo per lavorazioni artistiche.

ARREDI DA GIARDINO, PER ESTERNI IN FERRO BATTUTO

Fioriere, portafiori, lanterne e lampade a stelo, a muro, a catena, in stile "Liberty floreale".



PREMIO QUALITÀ ITALIA

**MANIGLIE PER PORTE, PORTONI,
IMPOSTE, FINESTRE.**



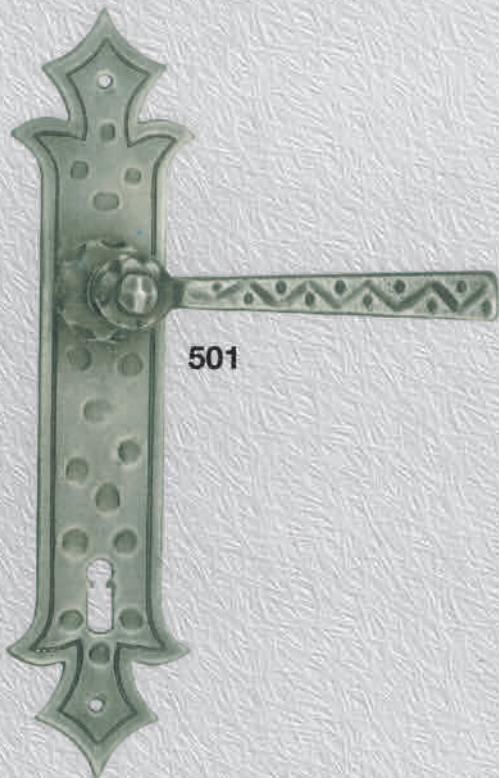

501



12

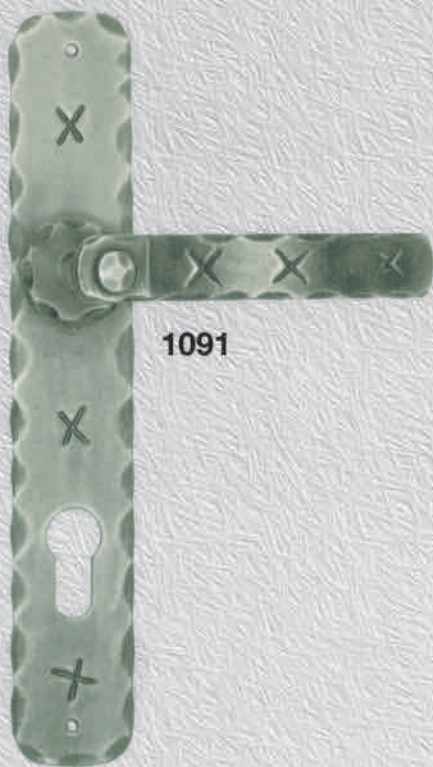

1091

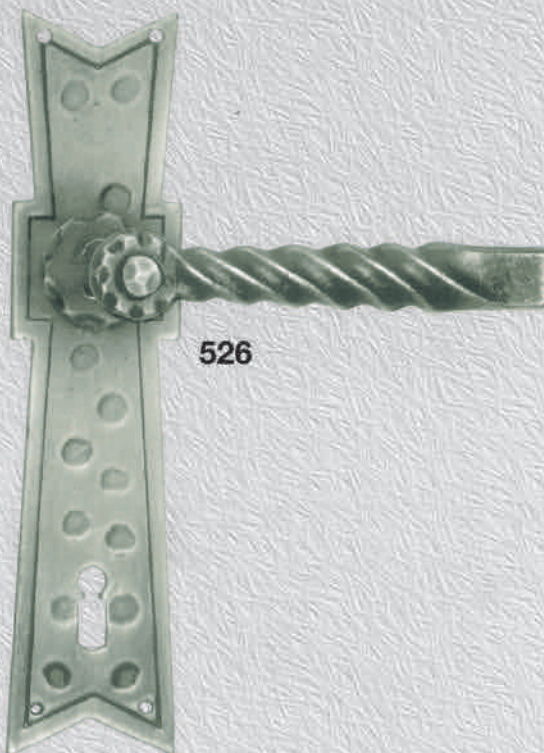

526



MANIGLIE PER PORTE

- | | | |
|-----------|----------------------|----------------------|
| Art. 501 | - impugnatura mm 125 | - placca mm 245x60x2 |
| Art. 12 | - impugnatura mm 120 | - placca mm 250x45x2 |
| Art. 1091 | - impugnatura mm 120 | - placca mm 240x40x2 |
| Art. 526 | - impugnatura mm 130 | - placca mm 210x50x2 |

Quadro 8 mm.
 A richiesta foro normale o Yale
 A richiesta molla richiamo impugnatura



505



313



314

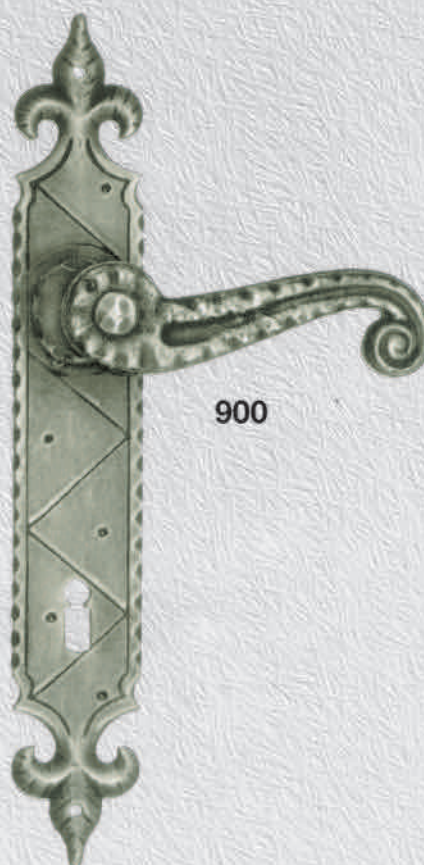

900

MANIGLIE PER PORTE

Art. 505	- impugnatura mm 135	- placca mm 250x50x2
Art. 313	- impugnatura mm 130	- placca mm 255x60x2
Art. 314	- impugnatura mm 135	- placca mm 275x60x2
Art. 900	- impugnatura mm 120	- placca mm 270x40x2

Quadro 8 mm.

A richiesta foro normale o Yale

A richiesta molla richiamo impugnatura

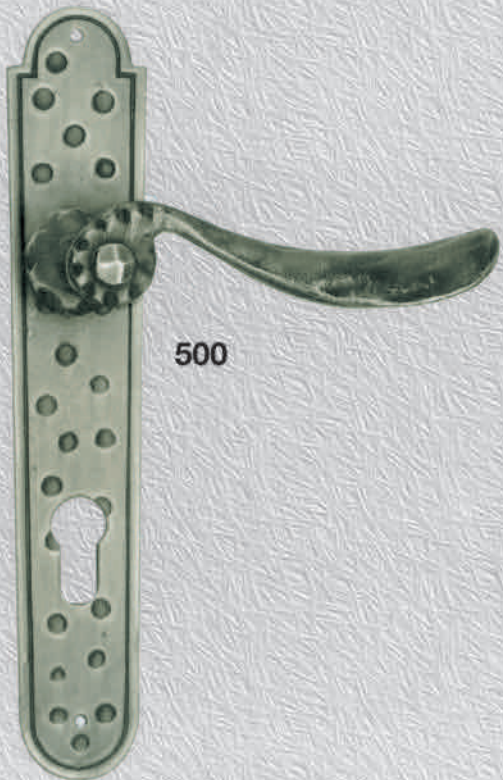

500



10



1093

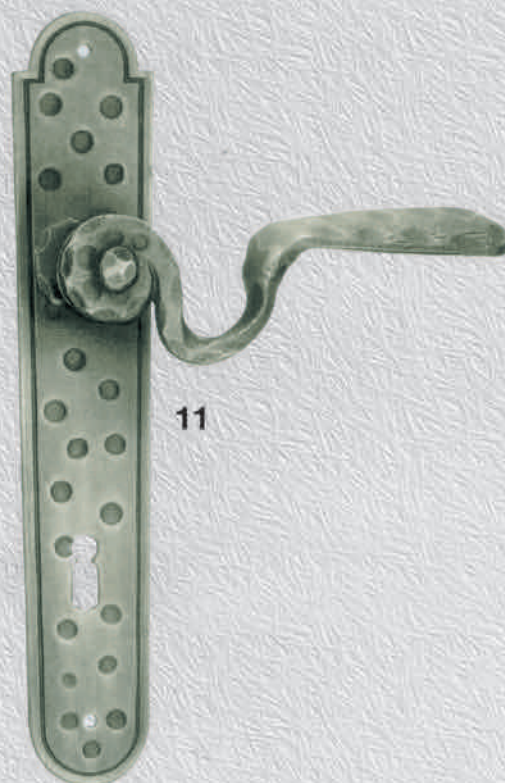

11



MANIGLIE PER PORTE

Quadro 8 mm.

A richiesta foro normale o Yale

A richiesta molla richiamo impugnatura

Art. 500

Art. 10

Art. 1093

Art. 11

- impugnatura mm 135

- impugnatura mm 140

- impugnatura mm 140

- impugnatura mm 145

- placca mm 250x45x2

- placca mm 245x45x2

- placca mm 240x55x2

- placca mm 250x45x2

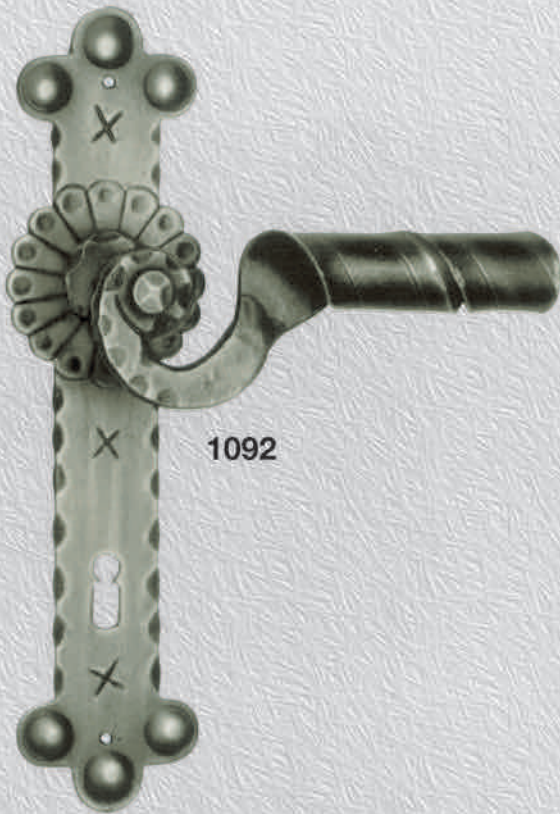

1092

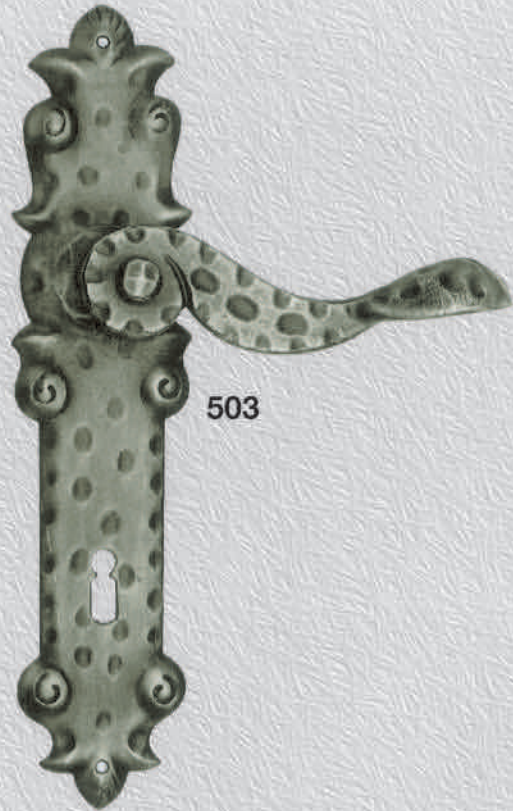

503



527



506

MANIGLIE PER PORTE

Art. 1092	- impugnatura mm 140	- placca mm 255x65x2
Art. 503	- impugnatura mm 140	- placca mm 255x60x2
Art. 527	- impugnatura mm 130	- placca mm 255x60x2
Art. 506	- impugnatura mm 125	- placca mm 240x40x2

Quadro 8 mm.

A richiesta foro normale o Yale

A richiesta molla richiamo impugnatura

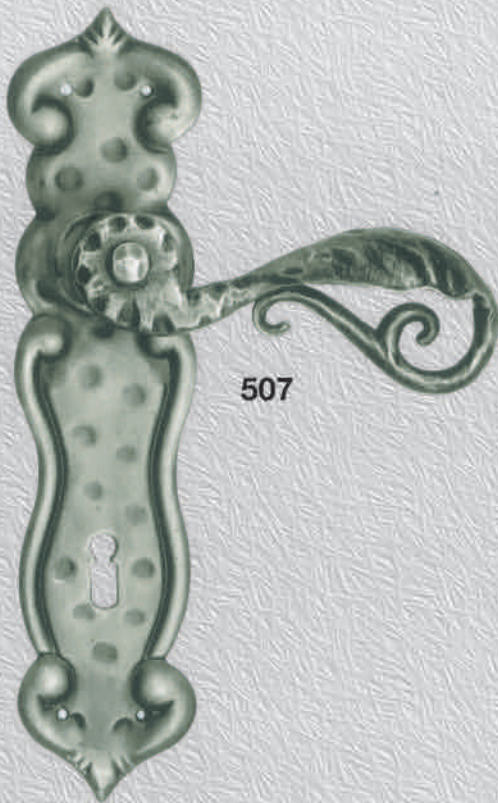

507

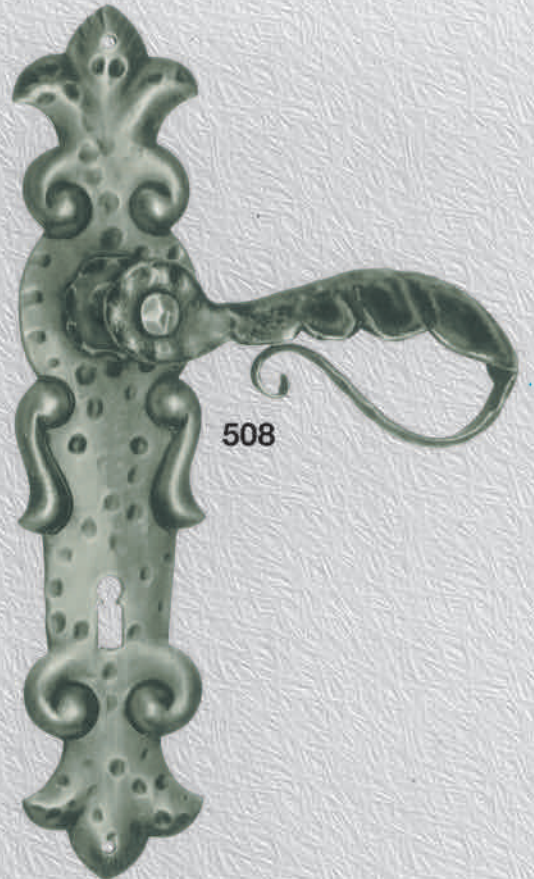

508



313/WC



13/WC

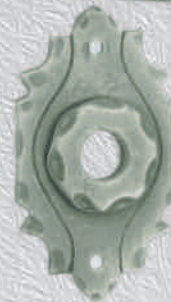
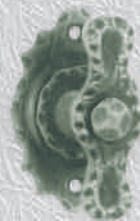

**MANIGLIE PER PORTE
MANIGLIE PER TOILETTES**

Quadro 8 mm.
A richiesta foro normale o Yale
A richiesta molla richiamo impugnatura

- | | | |
|-------------|--|--|
| Art. 507 | - impugnatura mm 135 | - placca mm 255x60x2 |
| Art. 508 | - impugnatura mm 140 | - placca mm 280x65x2 |
| Art. 313/WC | - impugnatura mm 130
distanza quadri mm70 | - placca mm 255x60x2 |
| Art. 13/WC | - impugnatura mm 125 | - rosetta mm 90x50x2
bocchetta mm 60x40x2 |

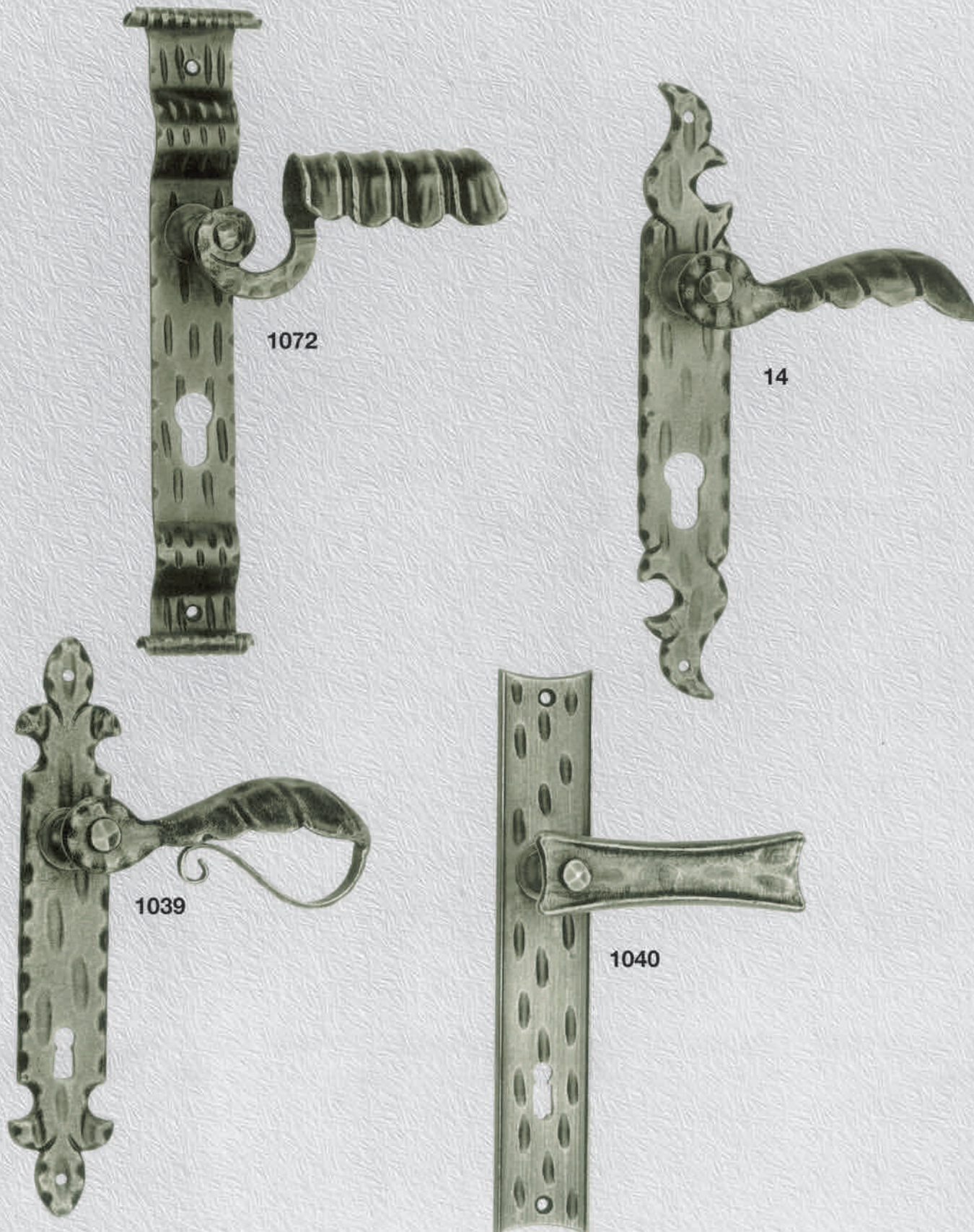

**MANIGLIE MASSICCE PER PORTE
CON MOLLA DI RICHIAMO**

- | | | |
|------------------|----------------------|----------------------|
| Art. 1072 | - impugnatura mm 140 | - placca mm 300x40x5 |
| Art. 14 | - impugnatura mm 140 | - placca mm 280x40x5 |
| Art. 1039 | - impugnatura mm 140 | - placca mm 260x40x5 |
| Art. 1040 | - impugnatura mm 120 | - placca mm 250x45x6 |

Quadro 8 mm.
A richiesta foro normale o Yale



15



901



510



16



18



17



511



512

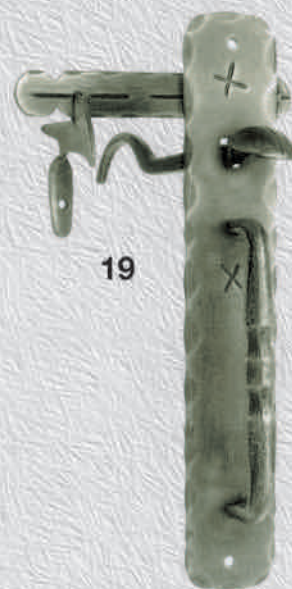

19



MANIGLIE PER PORTE MANIGLIE A GRUCIA CON NOTTOLINO PER PORTE

Quadro 8 mm.

A richiesta foro normale o Yale

A richiesta molla richiamo impugnatura

Art. 15
Art. 901
Art. 510
Art. 16
Art. 18
Art. 17
Art. 511
Art. 512
Art. 19

- impugnatura mm 135
- impugnatura mm 120
- impugnatura mm 130
- impugnatura mm 120
- impugnatura mm 140
- impugnatura mm 125
- impugnatura mm 140
- maniglia mm 100
- maniglia mm 125

- rosetta mm 90x50x2
- rosetta mm 100x40x2
- rosetta mm 90x50x2
- rosetta mm 60x40x2
- rosetta mm 90x35x2
- rosetta mm 90x50x2
- rosetta ø mm 60x2
- placca mm 240x145x2
- placca mm 240x40x2

- Bocchetta mm 60x40x2
- Bocchetta mm 70x35x2
- Bocchetta mm 60x40x2
- Bocchetta mm 60x40x2
- Bocchetta mm 55x30x2
- Bocchetta mm 60x40x2
- Bocchetta ø mm 50x2
- Con nottolino
- Con nottolino



59



60



520

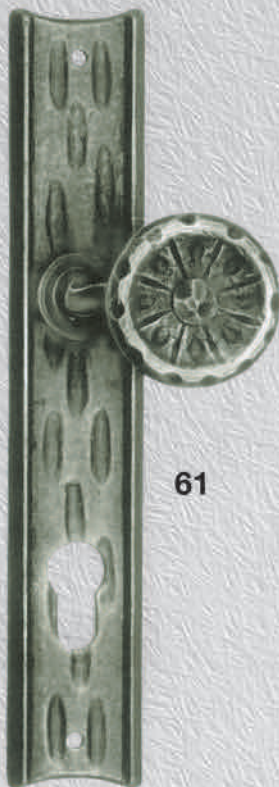

61

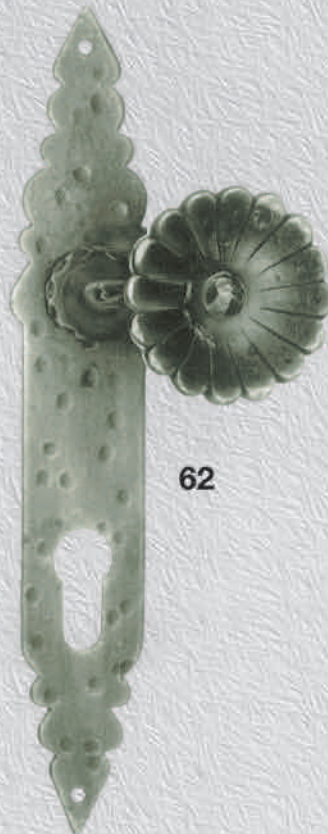

62



521

POMOLI SU PLACCA FISSI O GIREVOLI

Pomoli girevoli quadro 8 mm.

- | | | |
|------------|--------------------------|----------------------------------|
| Art. 59/F | - pomolo ø mm 75 | - fisso su placca mm 280x65x2 |
| Art. 59/G | - pomolo ø mm 75 | - girevole su placca mm 280x65x2 |
| Art. 60/F | - pomolo ø mm 65 | - fisso su placca mm 275x60x2 |
| Art. 60/G | - pomolo ø mm 65 | - girevole su placca mm 275x60x2 |
| Art. 520/F | - pomolo ø mm 55 | - fisso su placca mm 250x50x2 |
| Art. 520/G | - pomolo ø mm 55 | - girevole su placca mm 250x50x2 |
| Art. 61/F | - pomolo zancato ø mm 55 | - fisso su placca mm 250x45x6 |
| Art. 62/F | - pomolo zancato ø mm 60 | - fisso su placca mm 240x45x2 |
| Art. 521/F | - pomolo ø mm 55 | - fisso su placca mm 250x45x2 |
| Art. 521/G | - pomolo ø mm 55 | - girevole su placca mm 250x45x2 |



308



524C



63



64



65



307



1042

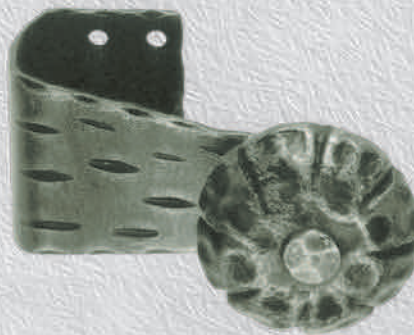

1046



66



POMOLI SU ROSETTA FISSI O GIREVOLI

Pomoli girevoli quadro 8 mm.

- Art. 308/F - pomolo ø mm 75 - fisso su rosetta ø mm 100x2
- Art. 308/G - pomolo ø mm 75 - girevole su rosetta ø mm 100x2
- Art. 524/CF - pomolo ø mm 65 - fisso su rosetta mm 75x75x2
- Art. 524/CG - pomolo ø mm 65 - girevole su rosetta mm 75x75x2
- Art. 63/F - pomolo ø mm 65 - fisso su rosetta mm 55x55x3

- Art. 63/G - pomolo ø mm 65 - girevole su rosetta mm 55x55x3
- Art. 64/F - pomolo ø mm 60 - fisso su rosetta mm 100x40x2
- Art. 64/G - pomolo ø mm 60 - girevole su rosetta mm 100x40x2
- Art. 65/F - pomolo ø mm 55 - fisso su rosetta mm 60x35x3
- Art. 65/G - pomolo ø mm 55 - girevole su rosetta mm 60x35x3
- Art. 307/F - pomolo ø mm 60 - fisso su rosetta mm 60x60x2
- Art. 307/G - pomolo ø mm 60 - girevole su rosetta mm 60x60x2
- Art. 1042 - pomolo zancato ø mm 60 - fisso su placca mm 120x60x3
- Art. 1046 - pomolo zancato ø mm 55 - fisso su placca mm 110x60x3
- Art. 66/F - pomolo ø mm 55 - fisso su rosetta ø mm 60x2
- Art. 66/G - pomolo ø mm 55 - girevole su rosetta ø mm 60x2



511/R



511/C



511/B



510/R



510/C



510/B



901/R



901/C



901/B



1043/R



1044/C



1045/B



617



617/A



1047/R



1048/C



1049/B

ROSETTE E BOCCHETTE PER MANIGLIE

- Art. 511/R - rosetta ø mm 60x2
- Art. 511/C - bocchetta foro yale ø mm 50x2
- Art. 511/B - bocchetta ø mm 50 foro normale
- Art. 510/R - rosetta mm 50x90x2
- Art. 510/C - bocchetta mm 40x60x2 foro yale
- Art. 510/B - bocchetta mm 40x60x2 foro normale
- Art. 901/R - rosetta mm 40x100x2
- Art. 901/C - bocchetta mm 35x70x2 foro yale

- Art. 901/B - bocchetta mm 35x70x2 foro normale
- Art. 1043/R - rosetta mm 85x35x2
- Art. 1044/C - bocchetta mm 35x85x2 foro yale
- Art. 1045/B - bocchetta mm 35x85x2 foro normale
- Art. 617/A - bocchetta mm 35x85x2 foro normale
- Art. 617 - bocchetta mm 85x35x2 foro normale
- Art. 1047/R - rosetta mm 38x60x3
- Art. 1048/C - bocchetta mm 38x60x3 foro yale
- Art. 1049/B - bocchetta mm 38x60x3 foro normale



902



545



1094



548



316



544



1099



549



CREMONESI - MARTELLINE CARIGLIONI

Quadro 7 mm.

* A richiesta gioco gratz con fori

Gioco gratz con perni

Gioco gratz con fori e quadro 7 mm.

Art. 902*

Art. 545*

Art. 1094*

Art. 548*

Art. 316*

Art. 544*

Art. 1099*

Art. 549*

- cremonese a martellina
- cremonese a cariglione
- a richiesta mov. MP/gratz

- cremonese a martellina
- cremonese a martellina
- cremonese a martellina
- cremonese a martellina
- cremonese a martellina
- cremonese a martellina

- impugnatura mm 85
- impugnatura mm 90

- impugnatura mm 85
- impugnatura mm 90
- impugnatura mm 100
- impugnatura mm 100
- impugnatura mm 100
- impugnatura mm 100

- placca mm 200x40x2
- placca a scatola mm 135x35

- placca mm 140x40x2
- placca mm 150x40x2
- placca mm 160x55x2
- placca mm 170x50x2
- placca mm 170x48x2
- placca mm 145x50x2



1100



541



586



319

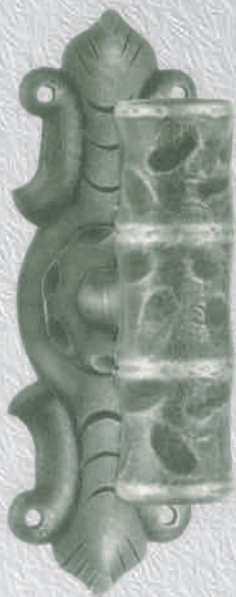

317



1051/A
1051/B

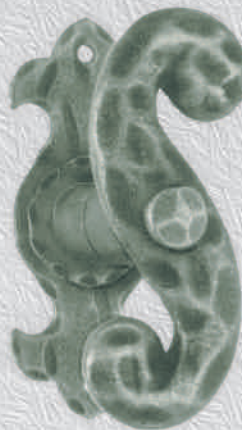

1050



67

CREMONESI - MARTELLINE

Quadro 7 mm. * A richiesta gioco gratz con fori

Gioco gratz con perni - Gioco gratz con fori e quadro 7 mm

Art. 1100* - cremonese a martellina - impugnatura mm 90

- placca mm 150x45x2

Art. 541 - cremonese a martellina - impugnatura mm 90

- placca mm 135x45x2

Art. 586* - cremonese a cariglione - impugnatura mm 100

- placca a scatola mm 135x35

Art. 319 - cremonese con passanti - impugnatura mm 90

- placca a scatola mm 125x32 - movimento MP per aste esterne

Art. 317* - cremonese a martellina - impugnatura mm 90

- placca mm 140x45x2

Art. 1051/A - cremonese a martellina - impugnatura destra mm 95

- placca mm 85x35x2

Art. 1051/B - cremonese a martellina - impugnatura sinistra mm 95

- placca mm 85x35x2

Art. 1050 - cremonese a martellina - impugnatura mm 95

- placca mm 85x35x2

Art. 67 - cremonese con passanti - impugnatura mm 100

- scatola mm 125x32 - movimento MP per aste esterne



82



83



84



85

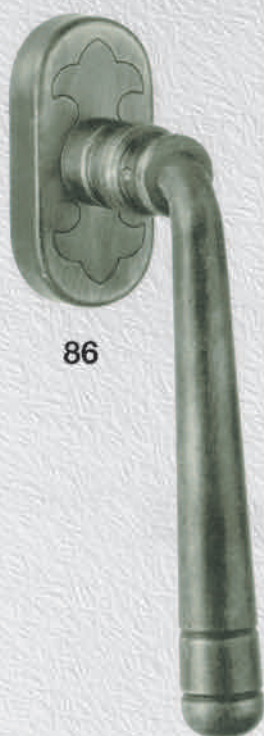

86



87



CREMONESI - MARTELLINE CON MOVIMENTO DRY KEEP

- | | | | |
|---------|-----------------|----------------------|--------------------|
| Art. 82 | - martellina DK | - impugnatura mm 125 | - scatola mm 65x32 |
| Art. 83 | - martellina DK | - impugnatura mm 125 | - scatola mm 65x32 |
| Art. 84 | - martellina DK | - impugnatura mm 120 | - scatola mm 65x32 |
| Art. 85 | - martellina DK | - impugnatura mm 120 | - scatola mm 65x32 |
| Art. 86 | - martellina DK | - impugnatura mm 125 | - scatola mm 65x32 |
| Art. 87 | - martellina DK | - impugnatura mm 120 | - scatola mm 65x32 |

A richiesta scatola con movimento Dry Keep montato su tutte le impugnature a martellina

**GUARNITURE PER PORTE, PORTONI,
IMPOSTE, FINESTRE.**





633



322



634



912

MANIGLIONI - BATTENTI - PER PORTE E PORTONI

- | | | |
|-----------------|--------------------------|-----------------------|
| Art. 633 | - battente mm 250x30x30 | - piastre mm 75x75x3 |
| Art. 322 | - battente mm 200x90 | - rosette ø mm 60x2 |
| Art. 634 | - pendente mm 135x90xø10 | - piastra mm 90x52 |
| Art. 912 | - battente ø mm 85xø12 | - piastra mm 180x70x3 |



903



608



321



609

MANIGLIONI - BATTENTI - PER PORTE E PORTONI

- | | | |
|----------|---|---------------------------------|
| Art. 903 | - battente \varnothing mm 110 x \varnothing mm 16 | - piastra mm 240x80x4 |
| Art. 608 | - battente \varnothing mm 150 x \varnothing mm 25 | - rosette \varnothing mm 80x2 |
| Art. 321 | - battente \varnothing mm 110 x \varnothing mm 16 | - piastra mm 180x70x3 |
| Art. 609 | - battente \varnothing mm 130 x \varnothing mm 13 | - rosette \varnothing mm 50x2 |



1090



1010



611



320



909



323



632/A

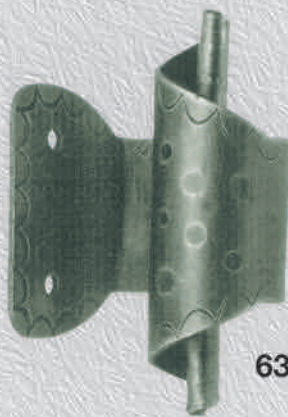

632/B



632/C



MANIGLIONI PER PORTE E PORTONI

- Art. 1090/A - maniglione diritto mm 200xø 25 - rosette ø mm 60x2
- Art. 1090/B - maniglione diritto mm 250xø 32 - rosette ø mm 80x2
- Art. 1090/C - maniglione diritto mm 300xø 32 - rosette ø mm 80x2
- Art. 1010/A - maniglione diritto mm 250x18x18 - piastra mm 480x80x4
- Art. 1010/B - maniglione diritto mm 350x18x18 - piastra mm 580x80x4

- Art. 611/A - maniglione diritto mm 280x20x20 - rosette mm 75x75x3
- Art. 611/B - maniglione diritto mm 330x20x20 - rosette mm 75x75x3
- Art. 320 - maniglione diritto mm 270x18x18 - rosette mm 60x60x3
- Art. 909 - maniglione zancato mm 250x18x18 - rosette mm 55x35x3
- distanza sui centri mm 40
- Art. 323 - maniglione diritto mm 240x15x15 - rosette mm 75x75x3
- Art. 632/A - maniglione zancato a ricciolo mm 200x110x4
- Art. 632/B - maniglione zancato a ricciolo mm 160x90x4
- Art. 632/C - maniglione zancato a ricciolo mm 110x60x3



699



326

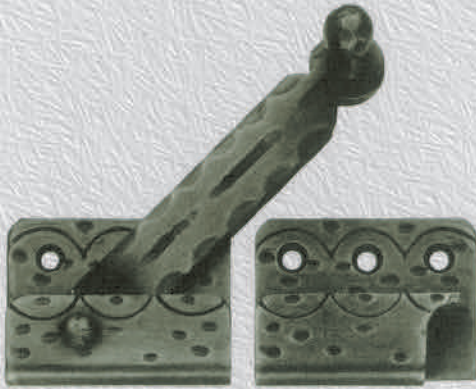

1095



725

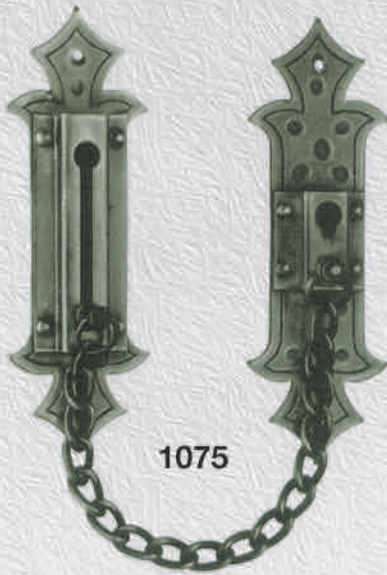

1075

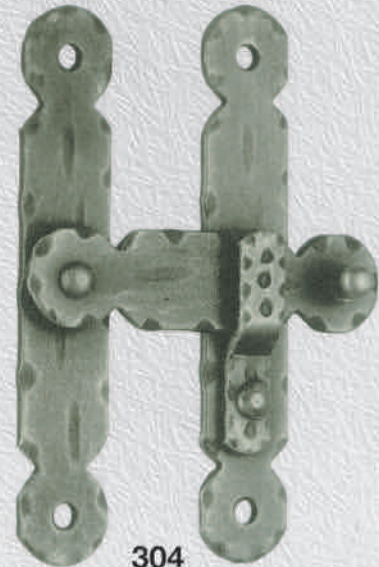

304

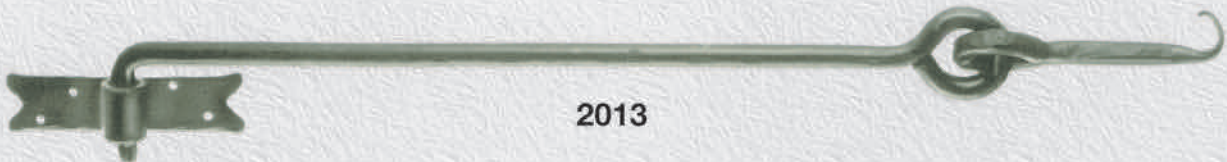

2013

CHIAVISTELLI PER PORTE E FINESTRE

Art. 699 - chiavistello mm 20x170x5 - piastra mm 75x75x2
Art. 326/A - chiavistello con collo mm 20x65x3
 - piastra mm 160x25x2 - collo mm 15

Art. 326/B - chiavistello con collo mm 20x65x3
 - piastra mm 160x25x2 - collo mm 20

Art. 1095 - chiavistello blocca imposte con fermo mm 50x125x2

Art. 725/A - cavalletto a rullo sporgenza mm 20

Art. 725/B - cavalletto a rullo sporgenza mm 25

Art. 1075 - catena di sicurezza per porta - piastre mm 175x55x3

Art. 304 - chiavistello mm 110x80x3 - piastre mm 110x20x3

Art. 2013/A - spranga per porta mm 500 x ø mm 16 con zanca a muro
 - piastra mm 170x40x5

Art. 2013/B - spranga per porta mm 700 x ø mm 18 con zanca a muro
 - piastra mm 170x40x5

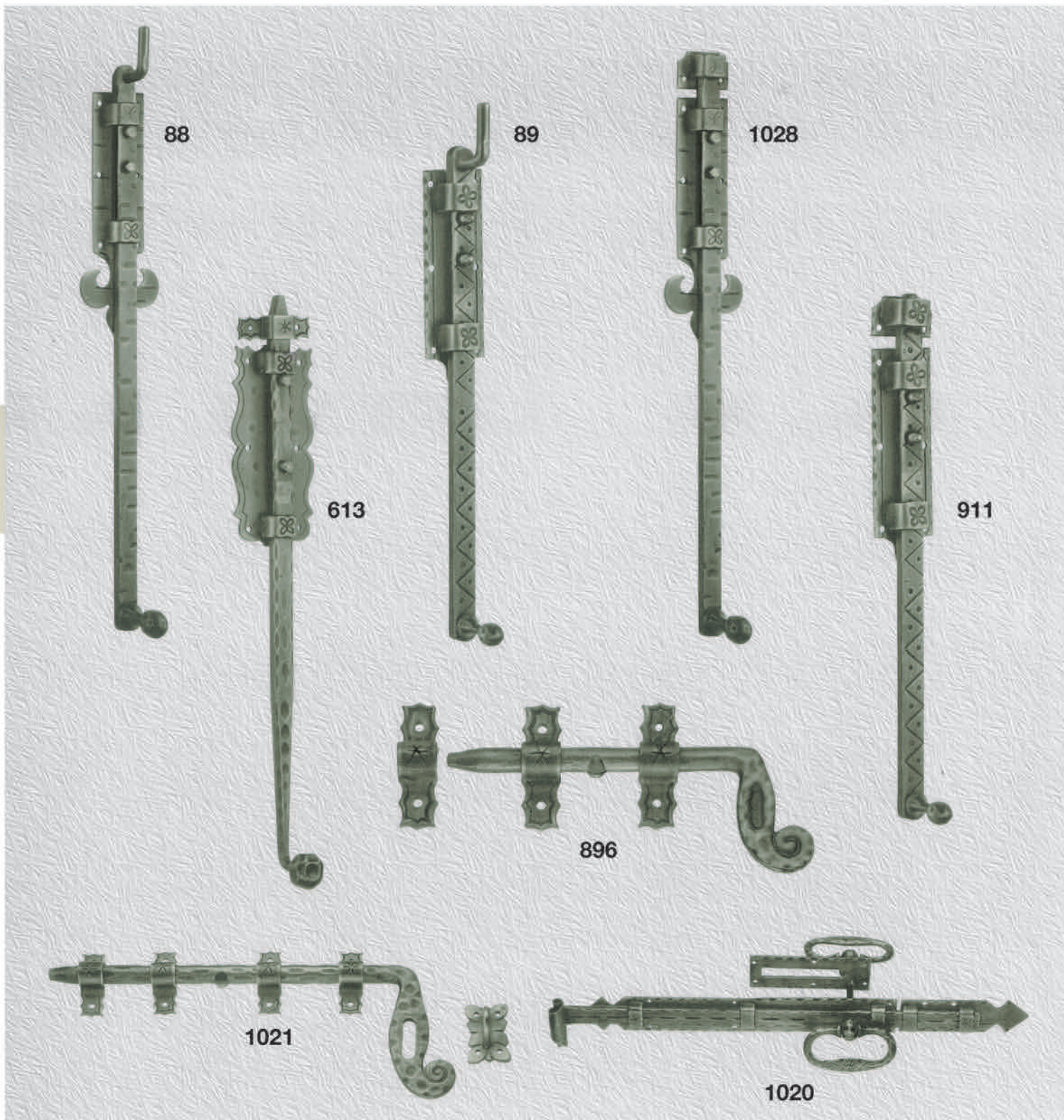

CATENACCI A CODA - CATENACCI A TRAVERSO E PORTA LUCCHETTO

A richiesta catenacci a coda lunghezza dell'asta a misura

- Art. 88/A** - catenaccio a coda con ginocchio mm 300x15x8
- piastra mm 180x65x2
- Art. 88/B** - catenaccio a coda con ginocchio mm 400x15x8
- piastra mm 180x65x2
- Art. 88/C** - catenaccio a coda con ginocchio mm 500x15x8
- piastra mm 180x65x2
- Art. 88/D** - catenaccio a coda con ginocchio mm 600x15x8
- piastra mm 180x65x2
- Art. 88/E** - catenaccio a coda con ginocchio mm 700x15x8
- piastra mm 180x65x2
- Art. 89/A** - catenaccio a coda con ginocchio mm 200x15x8
- piastra mm 120x40x2
- Art. 89/B** - catenaccio a coda con ginocchio mm 300x15x8
- piastra mm 120x40x2

- Art. 89/C** - catenaccio a coda con ginocchio mm 400x15x8
- piastra mm 120x40x2
- Art. 89/D** - catenaccio a coda con ginocchio mm 500x15x8
- piastra mm 120x40x2
- Art. 89/E** - catenaccio a coda con ginocchio mm 600x15x8
- piastra mm 120x40x2
- Art. 89/F** - catenaccio a coda con ginocchio mm 700x15x8
- piastra mm 120x40x2
- Art. 1028/A** - catenaccio a coda mm 300x15x8 - piastra mm 180x65x2
- Art. 1028/B** - catenaccio a coda mm 400x15x8 - piastra mm 180x65x2
- Art. 1028/C** - catenaccio a coda mm 500x15x8 - piastra mm 180x65x2
- Art. 1028/D** - catenaccio a coda mm 600x15x8 - piastra mm 180x65x2
- Art. 1028/E** - catenaccio a coda mm 700x15x8 - piastra mm 180x65x2
- Art. 613/A** - catenaccio a coda mm 300x15x8 - piastra mm 140x65x2
- Art. 613/B** - catenaccio a coda mm 350x15x8 - piastra mm 140x65x2
- Art. 613/C** - catenaccio a coda mm 400x15x8 - piastra mm 140x65x2
- Art. 911/A** - catenaccio a coda mm 200x15x8 - piastra mm 120x40x2
- Art. 911/B** - catenaccio a coda mm 300x15x8 - piastra mm 120x40x2

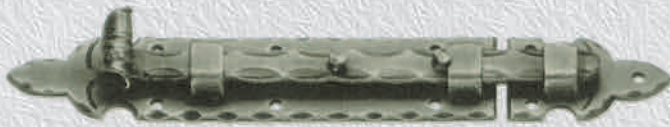

303/A



303/B



732



897



1029



325



612



910

- Art. 911/C - catenaccio a coda mm 400x15x8 - piastra mm 120x40x2
- Art. 911/D - catenaccio a coda mm 500x15x8 - piastra mm 120x40x2
- Art. 911/E - catenaccio a coda mm 600x15x8 - piastra mm 120x40x2
- Art. 911/F - catenaccio a coda mm 700x15x8 - piastra mm 120x40x2
- Art. 896/A - catenaccio mm 150x50x10
- Art. 1021/B - catenaccio portalucchetto mm 260x60x14
- Art. 1021/C - catenaccio portalucchetto mm 350x60x16
- Art. 1021/D - catenaccio portalucchetto mm 450x80x18
- Art. 1020/A - catenaccio con contropiastra e doppia maniglia mm 500x40x5
- contropiastra mm 160x40x5
- Art. 1020/B - catenaccio con contropiastra e doppia maniglia mm 600x60x5
- contropiastra mm 250x60x5

CATENACCI A TRAVERSO

- Art. 303/A - catenaccio - mm 160x30x3
- Art. 303/B - catenaccio - mm 200x30x3
- Art. 732/A - catenaccio - mm 200x30x3

- Art. 732/B - catenaccio - mm 300x40x4
- Art. 732/C - catenaccio - mm 400x40x4
- Art. 897 - catenaccio - mm 105x40x3
- Art. 1029/A - catenaccio - mm 300x42x3
- Art. 1029/B - catenaccio - mm 400x80x3
- Art. 1029/C - catenaccio - mm 500x80x3
- Art. 325/A - catenaccio - mm 300x40x4
- Art. 325/B - catenaccio - mm 400x40x4
- Art. 325/C - catenaccio - mm 500x40x4
- Art. 612/A - catenaccio - mm 500x40x4
- Art. 612/B - catenaccio - mm 600x60x5
- Art. 910/A - catenaccio - mm 200x40x3
- Art. 910/B - catenaccio - mm 290x45x3
- Art. 910/C - catenaccio - mm 400x80x3
- Art. 910/D - catenaccio - mm 500x80x3
- Art. 910/E - catenaccio - mm 600x80x3

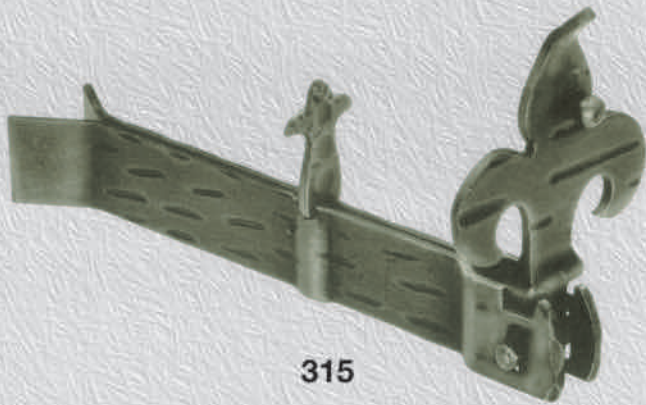

315

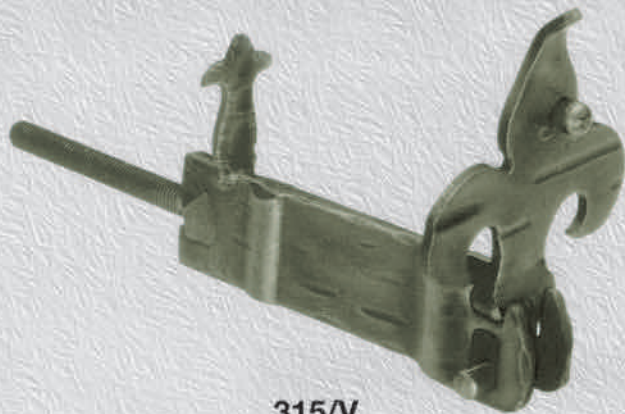

315/V

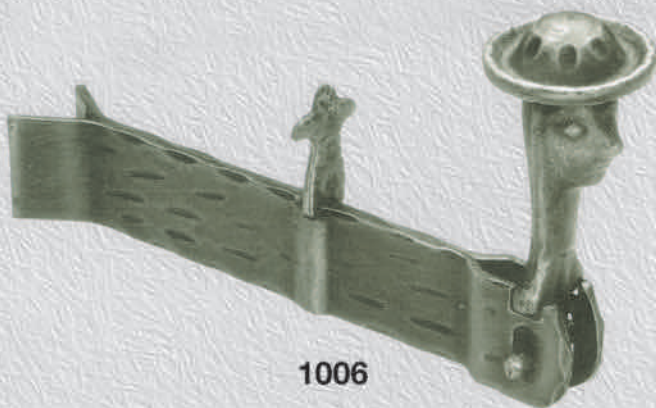

1006

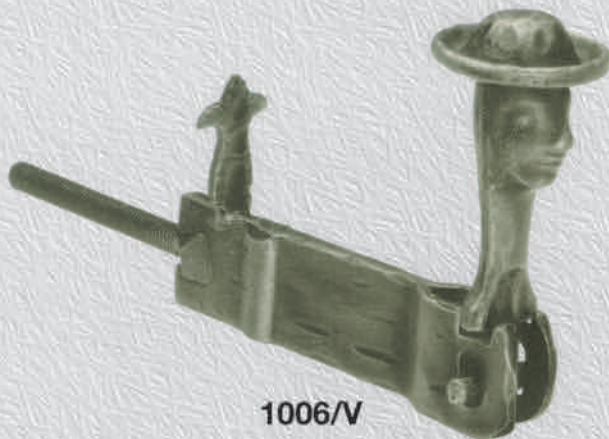

1006/V

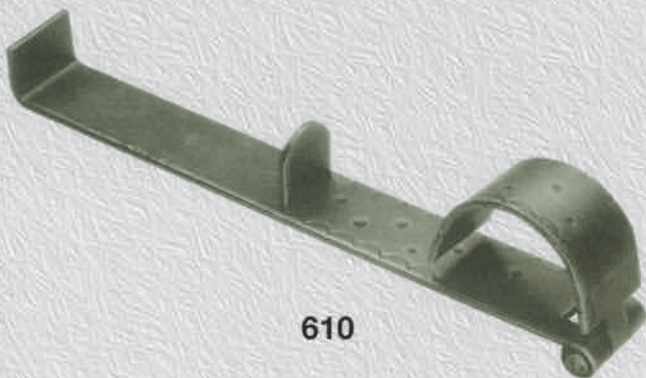

610

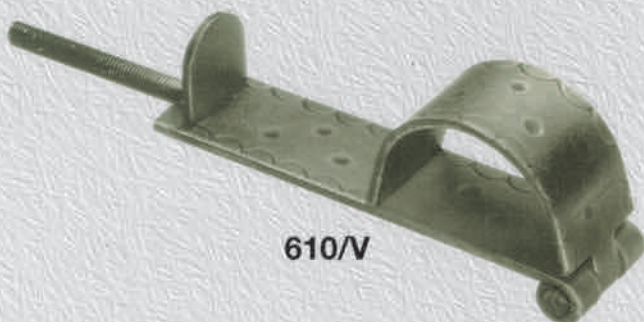

610/V



FERMAPERSIANE

- Art. 315** - fermapersiane zanca a murare mm 170x30x18
-iglio mm 95x60
- Art. 315/V** - fermapersiane mm 90x30x18
-iglio mm 95x60 - vite 8 Mx60
- Art. 1006** - fermapersiane zanca a murare mm 170x30x18
-ometto mm 110x40
- Art. 1006/V** - fermapersiane mm 90x30x18
-ometto mm 110x40 - vite 8 Mx60
- Art. 610** - fermapersiane zanca a murare mm 250x35x3
- Art. 610/V** - fermapersiane mm 140x35x3 - vite 8 Mx60



328



328/V



1101



1101/V

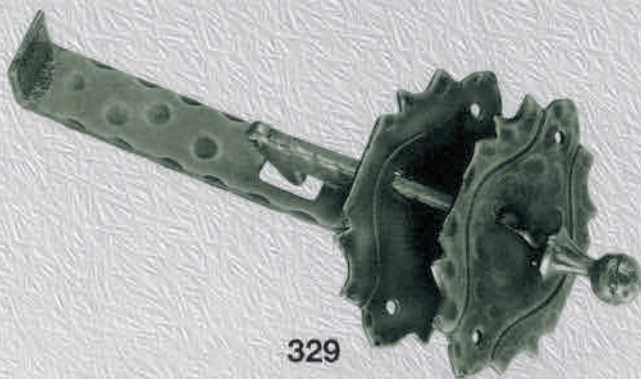

329



FERMAPERSIANE

- Art. 328 - fermapersiane zanca a murare mm 170x30x18
- giglio mm 135x95
- Art. 328/V - fermapersiane mm 90x30x18
- giglio mm 135x95 - vite 8MAx60
- Art. 1101 - fermapersiane zanca a murare mm 170x30x3
- Art. 1101/V - fermapersiane piastra a legno mm 170x30x3
- Art. 329 - fermapersiane zanca a murare mm 250
- piastra e contropiastra mm 90x50x2

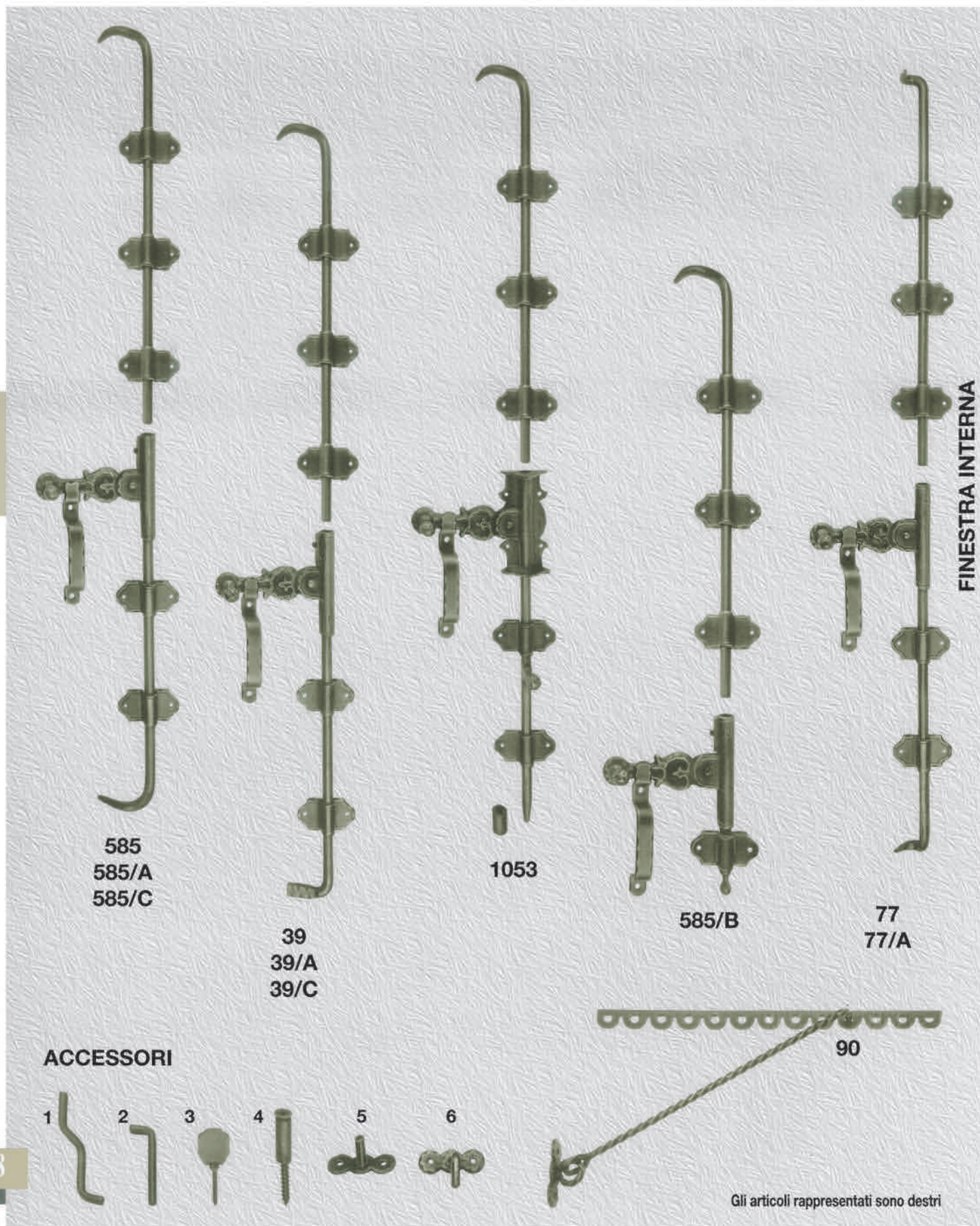

585
585/A
585/C

39
39/A
39/C

1053

585/B

77
77/A

ACCESSORI

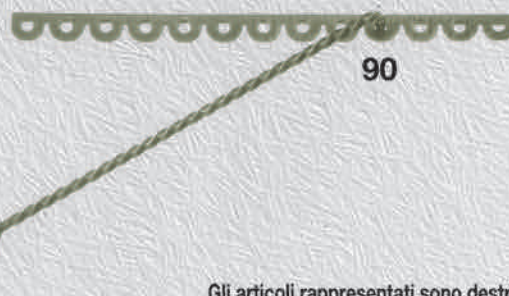

90
Gli articoli rappresentati sono destri



SPAGNOLETTE PER IMPOSTE

* Specificare se destra o sinistra

- Art. 585* - spagnoletta a 2 ganci mm 2000xø10
 Art. 585/A* - spagnoletta a 2 ganci mm 2500xø10
 Art. 585/C* - spagnoletta a 2 ganci mm 1600xø10
 Art. 39* - spagnoletta con gancio e paletta mm 2000xø10
 Art. 39/A* - spagnoletta con gancio e paletta mm 2500xø10
 Art. 39/C* - spagnoletta con gancio e paletta mm 1600xø10
 Art. 1053* - spagnoletta con gancio e asta scorrevole a catenaccio mm 2500xø 10

- Art. 585/B* - spagnoletta tronca con gancio mm 1600xø10
 Art. 77* - spagnoletta per finestra interna con due ganci mm 1600xø 10
 Art. 77/A* - spagnoletta per finestra interna con due ganci mm 2000xø 10
 Art. 90 - blocca imposte a differenti posizioni mm 300x20x15x2 asta mm 300 L. con piastra a legno

ACCESSORI

- Art. 1-2 - fermo a muro
 Art. 3-4 - fermo a vite
 Art. 5 - fermo a legno
 Art. 6 - fermo a legno con piego

**BANDELLE, CANTONALI,
CERNIERE PER PORTE, PORTONI,
IMPOSTE, FINESTRE.**

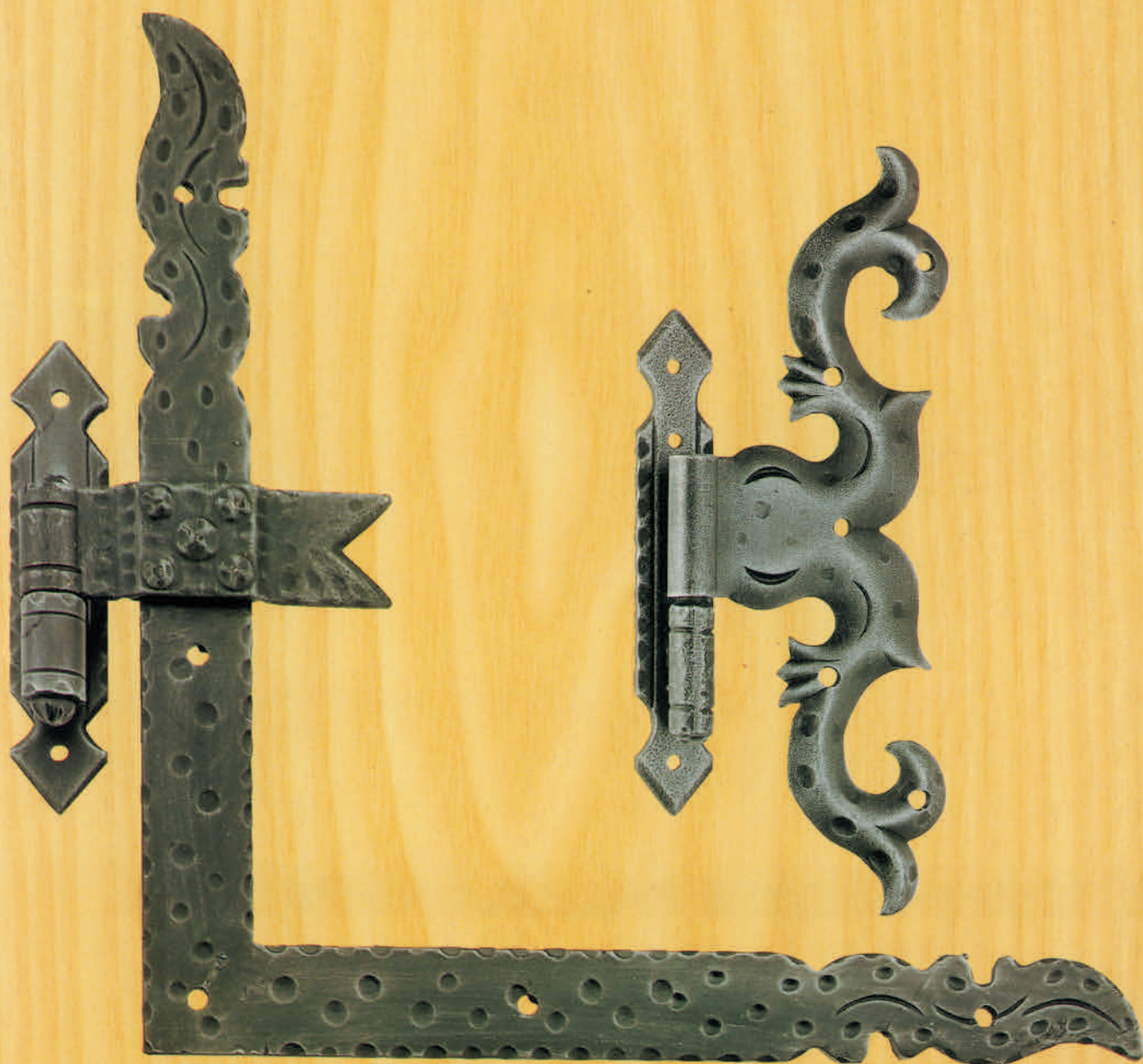

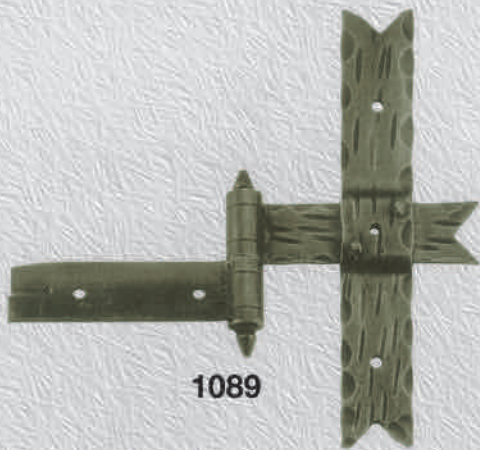

1089



1089/A



1088



580

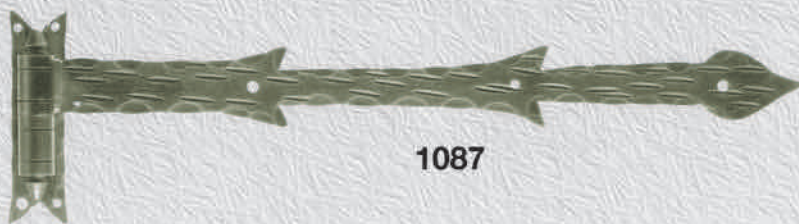

1087

Gli articoli rappresentati sono sinistri

BANDELLE - BANDELLE A SQUADRA MASSICCE PER PORTE E PORTONI

- | | |
|--|------------------------------------|
| Art. 1089/A - bandella a "T" mm 300x50x6 | - cardine a legno mm 160x40x6 |
| - distanza sui centri mm100 | - battuta mm 20 |
| Art. 1088/A* - bandella a squadra mm 350x600x65x6 | - cardine a legno mm 160x40x6 |
| - distanza sui centri mm100 | - battuta mm 20 |
| Art. 1088/B* - bandella a squadra mm 350x700x65x6 | - cardine a legno mm 160x40x6 |
| - distanza sui centri mm100 | - battuta mm 20 |
| Art. 1088/C* - bandella a squadra mm 350x800x65x6 | - cardine a legno mm 160x40x6 |
| - distanza sui centri mm100 | - battuta mm 20 |
| Art. 1088/D* - bandella a squadra mm 350x900x65x6 | - cardine a legno mm 160x40x6 |
| - distanza sui centri mm100 | - battuta mm 20 |
| Art. 580 - bandella mm 400x60x5 | - cardine a legno mm 190x40x5 ø 14 |
| | - battuta mm 22 |
| Art. 1087/A - bandella mm 600x65x6 | - cardine a legno mm 160x40x6 |
| | - battuta mm 20 |
| Art. 1087/B - bandella mm 700x65x6 | - cardine a legno mm 160x40x6 |
| | - battuta mm 20 |
| Art. 1087/C - bandella mm 800x65x6 | - cardine a legno mm 160x40x6 |
| | - battuta mm 20 |
| Art. 1087/D - bandella mm 900x65x6 | - cardine a legno mm 160x40x6 |
| | - battuta mm 20 |

* Specificare destra o sinistra

A richiesta zanca a murare, cardine a vite (vedi pag. 39)



581



914

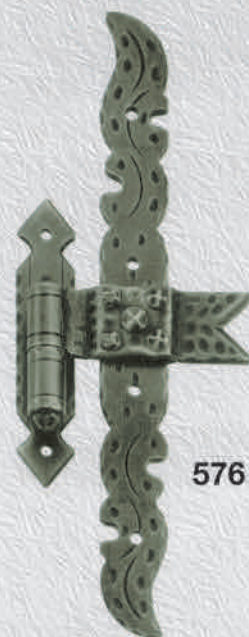

576

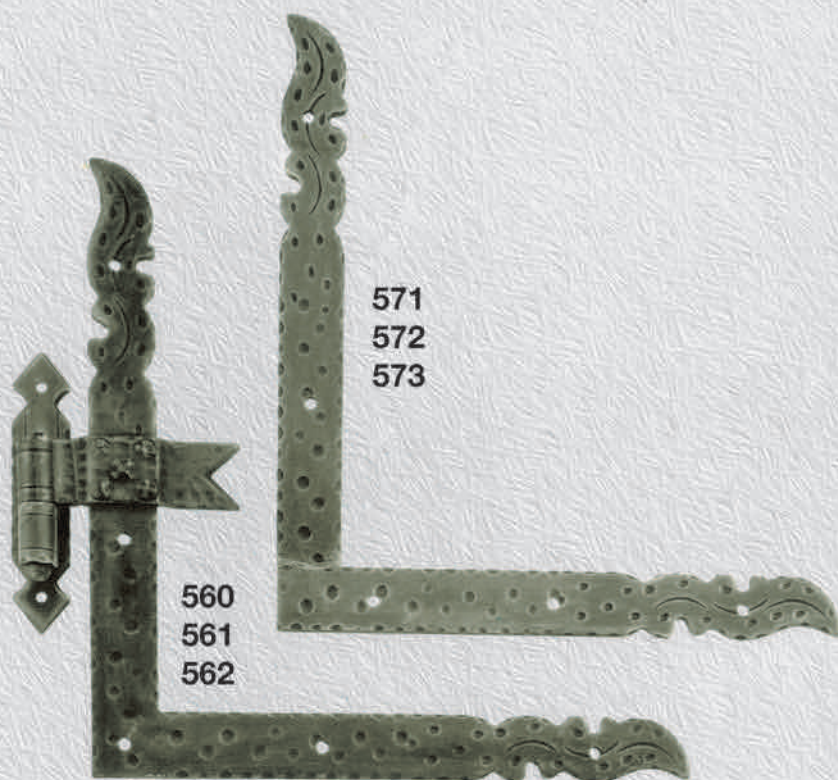

571
572
573

560
561
562

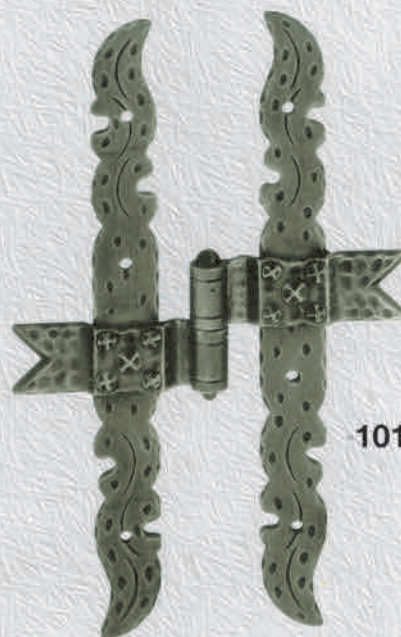

1011

Gli articoli rappresentati sono sinistri

BANDELLE - BANDELLE A SQUADRA - SQUADRE DI RINFORZO PER PORTE E FINESTRE

* Specificare destra o sinistra

A richiesta zanca a murare, cardine a vite (vedi pag. 39)

- Art. 581/A* - bandella mm 200x20x4 - cardine a legno mm 120x20x4 ø 10
- battuta mm 15
- Art. 581/B* - bandella mm 300x30x5 - cardine a legno mm 160x30x5 ø 12
- battuta mm 18
- Art. 581/C* - bandella mm 400x45x8 - cardine a legno mm 190x40x5 ø 16
- battuta mm 32
- Art. 581/D* - bandella mm 550x45x8 - cardine a legno mm 190x40x5 ø 16
- battuta mm 32
- Art. 576/A* - bandella a "T" mm 200x20x4 - cardine a legno mm 120x20x5 ø 10
- distanza sui centri mm 40 - battuta mm 20
- Art. 576/B* - bandella a "T" mm 300x30x5 - cardine a legno mm 160x30x5 ø 12
- distanza sui centri mm 45 - battuta mm 20

- Art. 576/C* - bandella a "T" mm 400x45x8 - cardine a legno mm 190x40x5 ø 16
- distanza sui centri mm 60 - battuta mm 32
- Art. 914/A - bandella doppia mm 400x30x5
- Art. 914/C - bandella doppia mm 600x45x8
- Art. 571 - squadra rinforzo mm 200x130x20x5
- Art. 572 - squadra rinforzo mm 300x250x30x5
- Art. 573 - squadra rinforzo mm 400x400x45x8
- Art. 560* - bandella a squadra mm 200x130x20x5 - cardine a legno mm 120x20x5 ø 10
- distanza sui centri mm 40 - battuta mm 20
- Art. 561* - bandella a squadra mm 300x250x30x5 - cardine a legno mm 160x30x5 ø 12
- distanza sui centri mm 45 - battuta mm 20
- Art. 562* - bandella a squadra mm 400x400x45x8 - cardine a legno mm 190x40x5 ø 16
- distanza sui centri mm 60 - battuta mm 32
- Art. 1011/A* - bandella a "T" doppia mm 200x20x4 - distanza sui centri mm 80
- Art. 1011/B* - bandella a "T" doppia mm 300x30x5 - distanza sui centri mm 90
- Art. 1011/C* - bandella a "T" doppia mm 400x45x8 - distanza sui centri mm 120

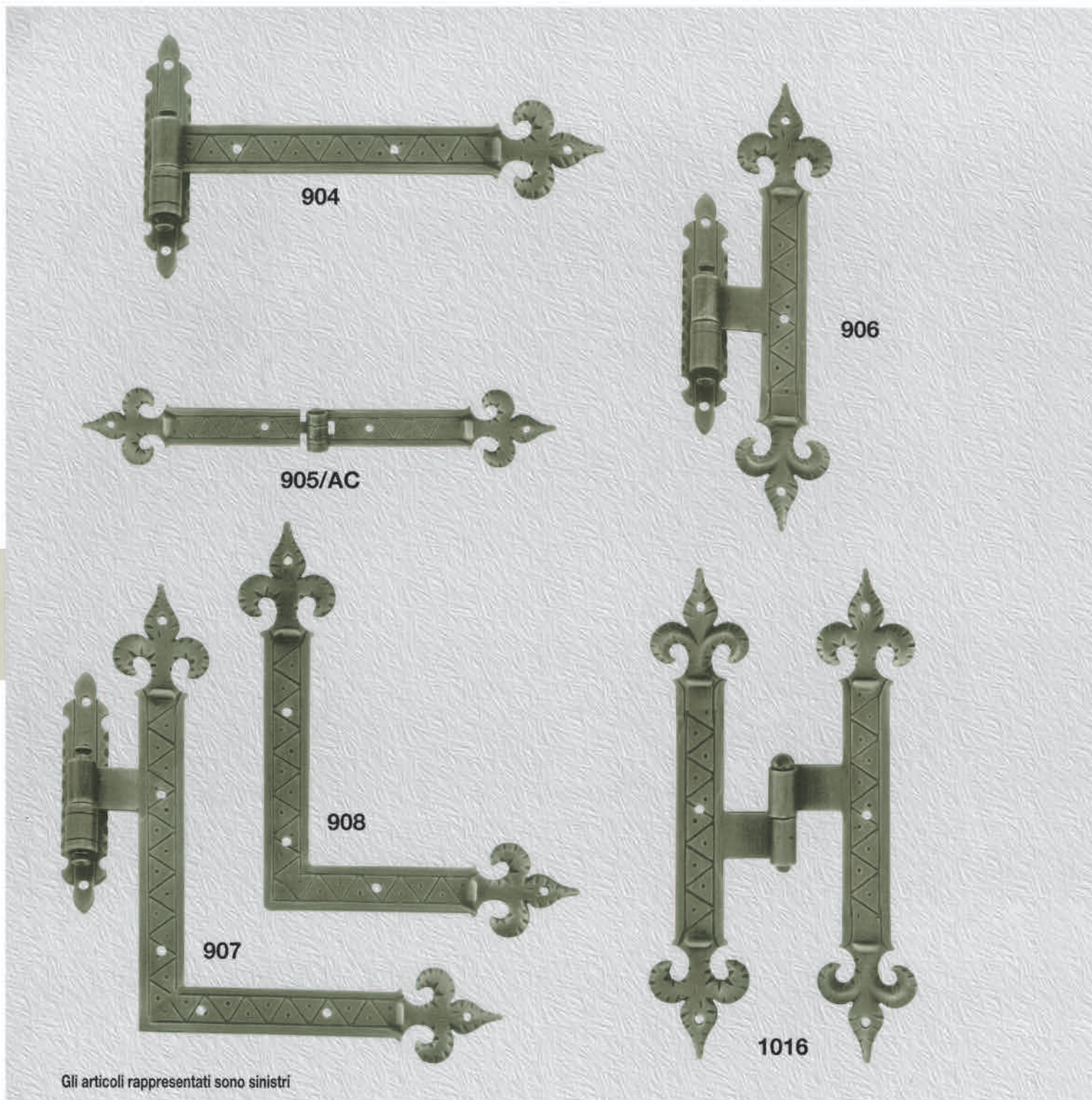

Gli articoli rappresentati sono sinistri

BANDELLE - BANDELLE A SQUADRA SQUADRE DI RINFORZO

* Specificare se destra o sinistra.

A richiesta zanca a murare, cardine a vite (vedi pag. 39)

- Art. 904/A** - bandella mm 200x45x3 - cardine a legno mm 120x20x3 ø 10
- battuta mm 15
- Art. 904/B** - bandella mm 250x45x3 - cardine a legno mm 120x20x3 ø 10
- battuta mm 15
- Art. 904/C** - bandella mm 300x65x3 - cardine a legno mm 160x30x4 ø 12
- battuta mm 18
- Art. 904/D** - bandella mm 350x65x3 - cardine a legno mm 160x30x4 ø 12
- battuta mm 18
- Art. 904/E** - bandella mm 400x80x4 - cardine a legno mm 190x40x5 ø 14
- battuta mm 22
- Art. 904/F** - bandella mm 500x80x4 - cardine a legno mm 190x40x5 ø 14
- battuta mm 22
- Art. 906/A** - bandella a "T" mm 200x45x3 - cardine a legno mm 120x20x3 ø 10
- distanza sui centri mm 35 - battuta mm 15
- Art. 906/B** - bandella a "T" mm 300x65x3 - cardine a legno mm 160x30x4 ø 12
- distanza sui centri mm 55 - battuta mm 18

- Art. 906/C** - bandella a "T" mm 400x80x4 - cardine a legno mm 190x40x5 ø 14
- distanza sui centri mm 75 - battuta mm 22
- Art. 905/A** - bandella doppia mm 400x65x3
- Art. 905/C** - bandella doppia mm 700x80x4
- Art. 908/A*** - squadra rinforzo mm 180x130x45x3
- Art. 908/B*** - squadra rinforzo mm 250x200x65x3
- Art. 908/C*** - squadra rinforzo mm 300x250x65x3
- Art. 908/D*** - squadra rinforzo mm 400x350x80x4
- Art. 907/A*** - bandella a squadra mm 180x130x45x3 - cardine a legno mm 120x20x3 ø 10
- distanza sui centri mm 35 - battuta mm 15
- Art. 907/B*** - bandella a squadra mm 250x200x65x3 - cardine a legno mm 160x30x4 ø 12
- distanza sui centri mm 55 - battuta mm 18
- Art. 907/C*** - bandella a squadra mm 300x250x65x3 - cardine a legno mm 160x30x4 ø 12
- distanza sui centri mm 55 - battuta mm 18
- Art. 907/D*** - bandella a squadra mm 400x350x80x4 - cardine a legno mm 190x40x5 ø 14
- distanza sui centri mm 75 - battuta mm 22
- Art. 1016/A*** - bandella a "T" doppia mm 200x45x3 - distanza sui centri mm 60
- Art. 1016/B*** - bandella a "T" doppia mm 300x65x3 - distanza sui centri mm 90
- Art. 1016/C*** - bandella a "T" doppia mm 400x80x4 - distanza sui centri mm 100

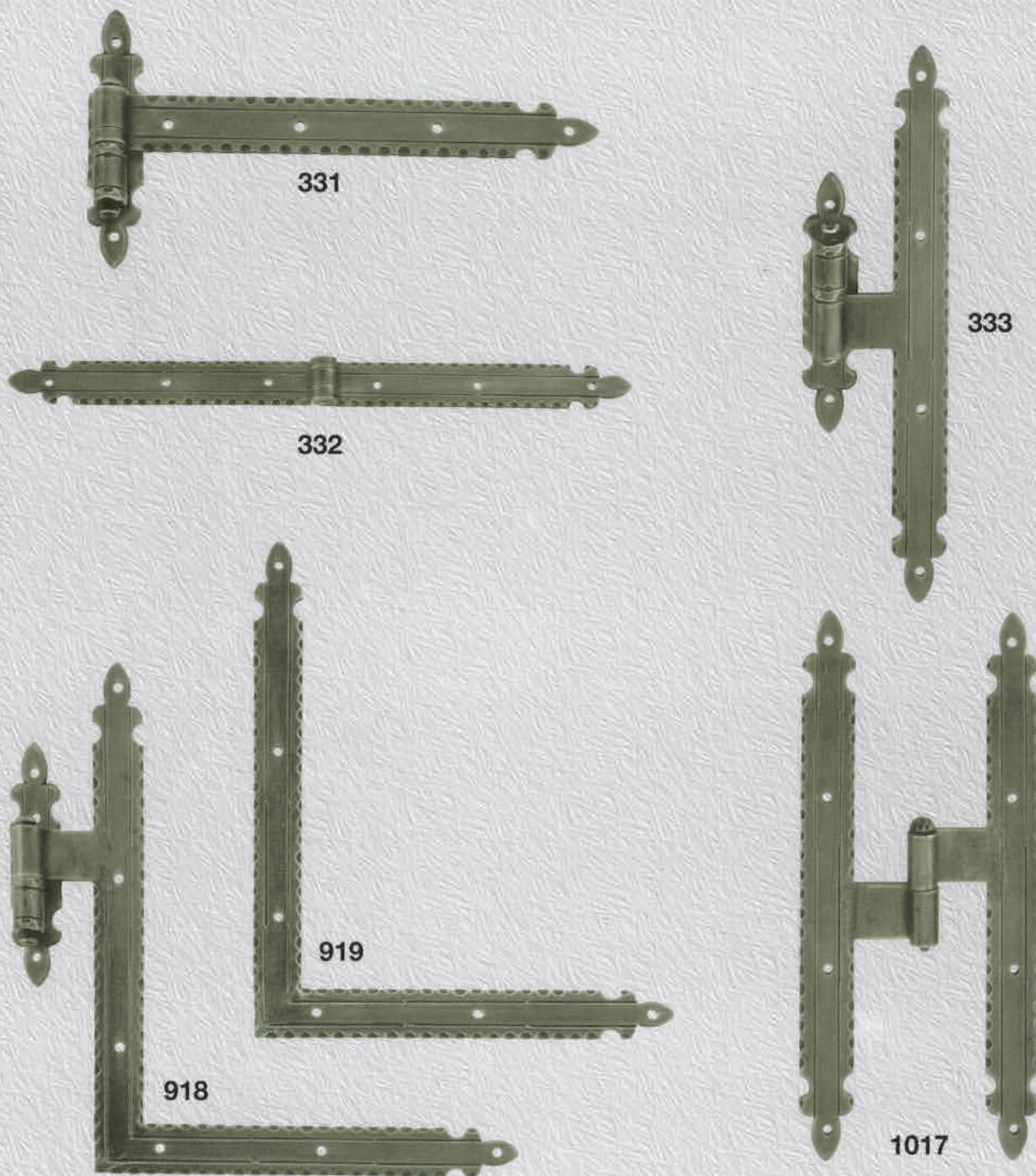

Gli articoli rappresentati sono sinistri

BANDELLE - BANDELLE A SQUADRA SQUADRE DI RINFORZO

* Specificare se destra o sinistra.

A richiesta zanca a murare, cardine a vite (vedi pag. 39)

- Art. 331/A** - bandella mm 150x20x3 - cardine a legno mm 120x20x3 ø 10
- battuta mm 15
- Art. 331/B** - bandella mm 200x20x3 - cardine a legno mm 120x20x3 ø 10
- battuta mm 15
- Art. 331/C** - bandella mm 250x30x4 - cardine a legno mm 160x30x4 ø 12
- battuta mm 18
- Art. 331/D** - bandella mm 300x30x4 - cardine a legno mm 160x30x4 ø 12
- battuta mm 18
- Art. 331/E** - bandella mm 350x40x5 - cardine a legno mm 190x40x5 ø 14
- battuta mm 22
- Art. 331/F** - bandella mm 400x40x5 - cardine a legno mm 190x40x5 ø 14
- battuta mm 22
- Art. 333/A** - bandella a "T" mm 200x20x3 - cardine a legno mm 120x20x3 ø 10
- distanza sui centri mm 35
- Art. 333/B** - bandella a "T" mm 300x30x4 - cardine a legno mm 160x30x4 ø 12
- distanza sui centri mm 55

- Art. 333/C** - bandella a "T" mm 400x40x5 - cardine a legno mm 190x40x5 ø 14
- distanza sui centri mm 75 - battuta mm 22
- Art. 332/A** - bandella doppia mm 400x30x4
- Art. 332/C** - bandella doppia mm 600x40x5
- Art. 919/A*** - squadra rinforzo mm 180x130x20x3
- Art. 919/B*** - squadra rinforzo mm 250x200x30x3
- Art. 919/C*** - squadra rinforzo mm 300x250x30x4
- Art. 919/D*** - squadra rinforzo mm 400x350x40x5
- Art. 918/A*** - bandella a squadra mm 180x130x20x3 - cardine a legno mm 120x20x3 ø 10
- distanza sui centri mm 35 - battuta mm 15
- Art. 918/B*** - bandella a squadra mm 250x200x30x4 - cardine a legno mm 160x30x4 ø 12
- distanza sui centri mm 35 - battuta mm 18
- Art. 918/C*** - bandella a squadra mm 300x250x30x4 - cardine a legno mm 160x30x4 ø 12
- distanza sui centri mm 55 - battuta mm 18
- Art. 918/D*** - bandella a squadra mm 400x350x40x5 - cardine a legno mm 190x40x5 ø 14
- distanza sui centri mm 75 - battuta mm 22
- Art. 1017/A*** - bandella a "T" doppia mm 200x20x3 - distanza sui centri mm 60
- Art. 1017/B*** - bandella a "T" doppia mm 300x30x4 - distanza sui centri mm 70
- Art. 1017/C*** - bandella a "T" doppia mm 400x40x5 - distanza sui centri mm 100



631



917



1014

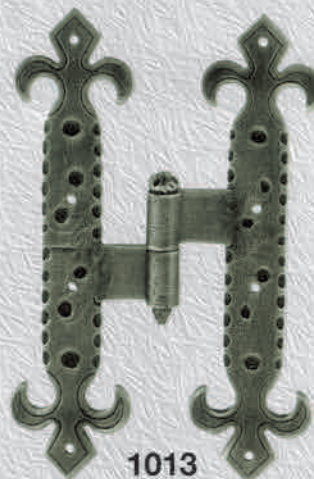

1013



1015



604

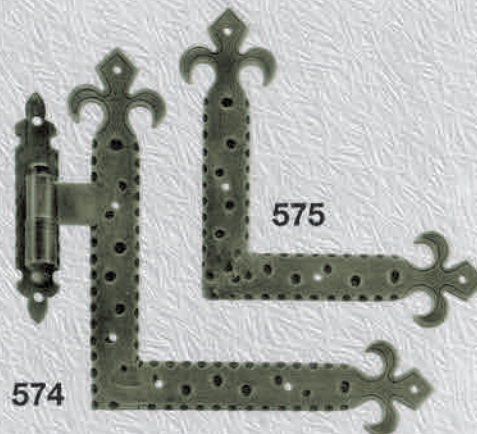

574

575

Gli articoli rappresentati sono sinistri

BANDELLE - BANDELLE A SQUADRA - SQUADRE DI RINFORZO PER PORTE E FINESTRE

* Specificare se destra o sinistra.

A richiesta zanca a murare, cardine a vite (vedi pag. 39)

Art. 917 - bandella a "T" mm 260x70x3 - cardine a legno mm 160x30x4 ø 12
- distanza sui centri mm 55 - battuta mm 18

Art. 1014/A* - bandella doppia mm 400x65x3

Art. 1014/B* - bandella doppia mm 500x65x3

Art. 1013* - bandella a "T" doppia mm 260x70x3 - distanza sui centri mm 110

Art. 1015/A* - cerniera doppia mm 160x70x3

Art. 1015/B* - cerniera doppia mm 180x75x3

Art. 604/A - bandella mm 200x60x3 - piastra mm 80x70x3

Art. 604/B - bandella mm 250x65x3 - piastra mm 90x75x3

Art. 604/C - bandella mm 300x75x3 - piastra mm 90x75x3

Art. 575/B - squadra rinforzo mm 200x200x50x3

Art. 575/C - squadra rinforzo mm 250x250x70x3

Art. 574/A* - bandella a squadra mm 260x160x70x3 - cardine a legno mm 160x30x4 ø 12
- distanza sui centri mm 55 - battuta mm 18

Art. 574/B* - bandella a squadra mm 200x200x50x3 - cardine a legno mm 120x20x3 ø 10
- distanza sui centri mm 40 - battuta mm 15

Art. 574/C* - bandella a squadra mm 250x250x70x3 - cardine a legno mm 160x30x4 ø 12
- distanza sui centri mm 55 - battuta mm 18

Art. 631/A - bandella mm 200x60x3 - cardine a legno mm 160x30x4 ø 12
- battuta mm 18

Art. 631/B - bandella mm 250x65x3 - cardine a legno mm 160x30x4 ø 12
- battuta mm 18

Art. 631/C - bandella mm 300x75x3 - cardine a legno mm 160x30x4 ø 12
- battuta mm 18



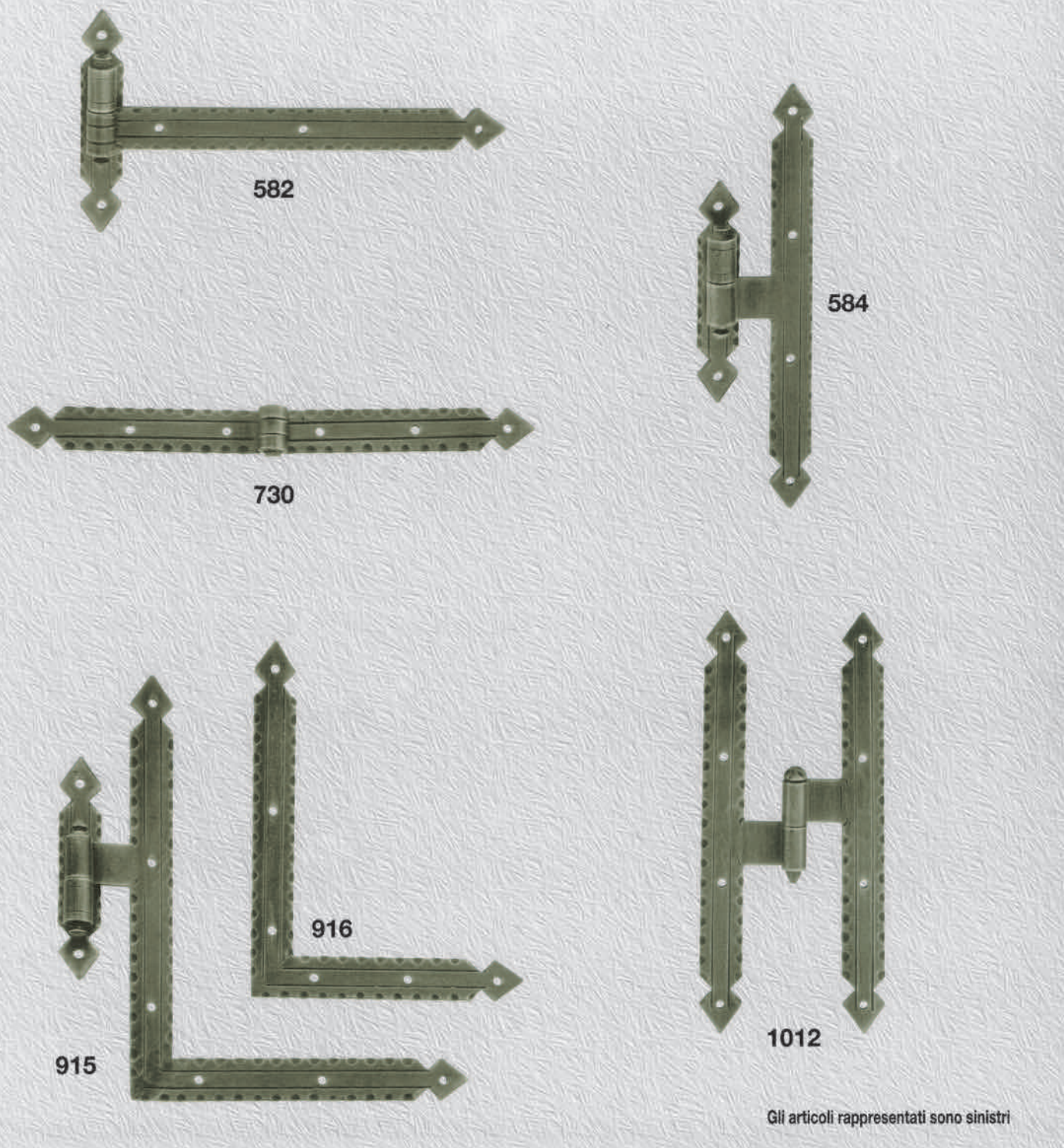

Gli articoli rappresentati sono sinistri

BANDELLE - BANDELLE A SQUADRA - SQUADRE DI RINFORZO

* Specificare se destra o sinistra.

A richiesta zanca a murare, cardine a vite (vedi pag. 39)

- Art. 582/A** - bandella mm 150x20x3 - cardine a legno mm 120x20x3 ø 10
- battuta mm 15
- Art. 582/B** - bandella mm 200x20x3 - cardine a legno mm 120x20x3 ø 10
- battuta mm 15
- Art. 582/C** - bandella mm 250x30x4 - cardine a legno mm 160x30x4 ø 12
- battuta mm 18
- Art. 582/D** - bandella mm 300x30x4 - cardine a legno mm 160x30x4 ø 12
- battuta mm 18
- Art. 582/E** - bandella mm 350x40x5 - cardine a legno mm 190x40x5 ø 14
- battuta mm 22
- Art. 582/F** - bandella mm 400x40x5 - cardine a legno mm 190x40x5 ø 14
- battuta mm 22
- Art. 584/A** - bandella a "T" mm 200x20x3 - cardine a legno mm 120x20x3 ø 10
- distanza sui centri mm 35 - battuta mm 15
- Art. 584/B** - bandella a "T" mm 300x30x4 - cardine a legno mm 160x30x4 ø 12
- distanza sui centri mm 55 - battuta mm 18

- Art. 584/C** - bandella a "T" mm 400x40x4 - cardine a legno mm 190x40x5 ø 14
- distanza sui centri mm 75 - battuta mm 22
- Art. 730/A** - bandella doppia mm 400x30x4
- Art. 730/C** - bandella doppia mm 600x40x5
- Art. 916/A*** - squadra rinforzo mm 180x130x20x3
- Art. 916/B*** - squadra rinforzo mm 250x200x30x4
- Art. 916/C*** - squadra rinforzo mm 300x250x30x4
- Art. 916/D*** - squadra rinforzo mm 400x350x40x4
- Art. 915/A*** - bandella a squadra mm 180x130x20x3 - cardine a legno mm 120x20x3 ø 10
- distanza sui centri mm 35 - battuta mm 15
- Art. 915/B*** - bandella a squadra mm 250x200x30x4 - cardine a legno mm 160x30x4 ø 12
- distanza sui centri mm 55 - battuta mm 18
- Art. 915/C*** - bandella a squadra mm 300x250x30x4 - cardine a legno mm 160x30x4 ø 12
- distanza sui centri mm 55 - battuta mm 18
- Art. 915/D*** - bandella a squadra mm 400x350x40x5 - cardine a legno mm 190x40x5 ø 14
- distanza sui centri mm 75 - battuta mm 22
- Art. 1012/A*** - bandella a "T" doppia mm 200x20x3 - distanza sui centri mm 60
- Art. 1012/B*** - bandella a "T" doppia mm 300x30x4 - distanza sui centri mm 70
- Art. 1012/C*** - bandella a "T" doppia mm 400x40x5 - distanza sui centri mm 100



93



94



95

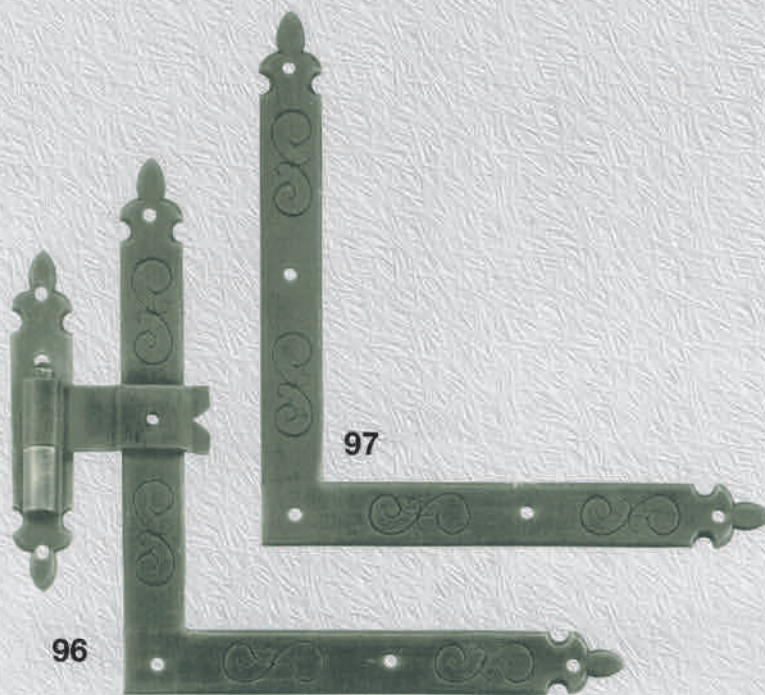

96

97

Gli articoli rappresentati sono sinistri

**BANDELLE - BANDELLE A SQUADRA
SQUADRE DI RINFORZO**

* Specificare se destra o sinistra.

A richiesta zanca a murare, cardine a vite (vedi pag. 39)



Galbusera

Art. 93/A - bandella mm 250x30x3 - cardine a legno mm 160x30x4 ø 12
- battuta mm 18

Art. 93/B - bandella mm 300x30x3 - cardine a legno mm 160x30x4 ø 12
- battuta mm 18

Art. 94/A - bandella a "T" mm 250x30x3 - cardine a legno mm 160x30x4 ø 12
- distanza sui centri mm 55 - battuta mm 18

Art. 94/B - bandella a "T" mm 300x30x3 - cardine a legno mm 160x30x4 ø 12
- distanza sui centri mm 55 - battuta mm 18

Art. 95/A* - bandella a "T" doppia mm 250x30x3 - distanza sui centri mm 70

Art. 95/B* - bandella a "T" doppia mm 300x30x3 - distanza sui centri mm 70

Art. 97/A - squadra rinforzo mm 250x250x30x3

Art. 97/B - squadra rinforzo mm 300x300x30x3

Art. 96/A* - bandella a squadra mm 250x250x30x3 - cardine a legno mm 160x30x4 ø 12
- distanza sui centri mm 55 - battuta mm 18

Art. 96/B* - bandella a squadra mm 300x300x30x3 - cardine a legno mm 160x30x4 ø 12
- distanza sui centri mm 55 - battuta mm 18

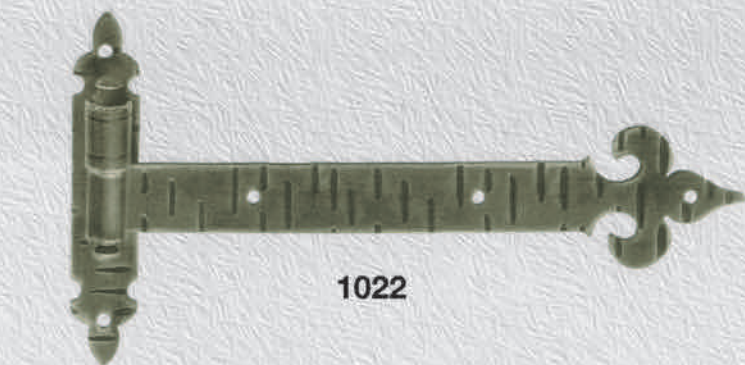

1022



1023



1024

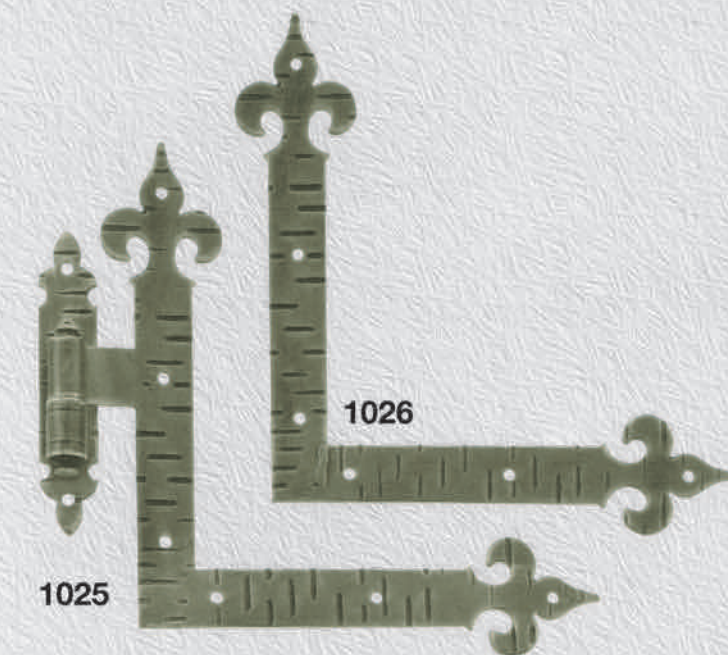

1025

1026



1027

Gli articoli rappresentati sono sinistri

BANDELLE - BANDELLE A SQUADRA - SQUADRE DI RINFORZO

* Specificare se destra o sinistra.

A richiesta zanca a murare, cardine a vite (vedi pag. 39)

- | | | |
|--------------------|------------------------------|------------------------------------|
| Art. 1022/B | - bandella mm 250x65x3 | - cardine a legno mm 160x30x4 ø 12 |
| | | - battuta mm 18 |
| Art. 1022/C | - bandella mm 300x65x3 | - cardine a legno mm 160x30x4 ø 12 |
| | | - battuta mm 18 |
| Art. 1022/D | - bandella mm 350x80x4 | - cardine a legno mm 190x40x5 ø 14 |
| | | - battuta mm 22 |
| Art. 1022/E | - bandella mm 400x80x4 | - cardine a legno mm 190x40x5 ø 14 |
| | | - battuta mm 22 |
| Art. 1024/B | - bandella a "T" mm 250x65x3 | - cardine a legno mm 160x30x4 ø 12 |
| | - distanza sui centri mm 55 | - battuta mm 18 |
| Art. 1024/C | - bandella a "T" mm 350x80x4 | - cardine a legno mm 190x40x5 ø 14 |
| | - distanza sui centri mm 75 | - battuta mm 22 |

Art. 1023/A - bandella doppia mm 400x65x3

Art. 1023/B - bandella doppia mm 500x65x3

Art. 1023/C - bandella doppia mm 600x80x4

Art. 1026/B - squadra rinforzo mm 250x250x65x3

Art. 1026/C - squadra rinforzo mm 300x300x65x3

Art. 1026/D - squadra rinforzo mm 350x350x80x4

Art. 1025/B* - bandella a squadra mm 250x250x65x3 - cardine a legno mm 160x30x4 ø 12

- distanza sui centri mm 55 - battuta mm 18

Art. 1025/C* - bandella a squadra mm 300x300x65x3 - cardine a legno mm 160x30x4 ø 12

- distanza sui centri mm 55 - battuta mm 18

Art. 1025/D* - bandella a squadra mm 350x350x80x4 - cardine a legno mm 190x40x5 ø 14

- distanza sui centri mm 75 - battuta mm 22

Art. 1027/B* - bandella a "T" doppia mm 250x65x3 - distanza sui centri mm 90

Art. 1027/C* - bandella a "T" doppia mm 350x80x4 - distanza sui centri mm 100



1001



1002



1003

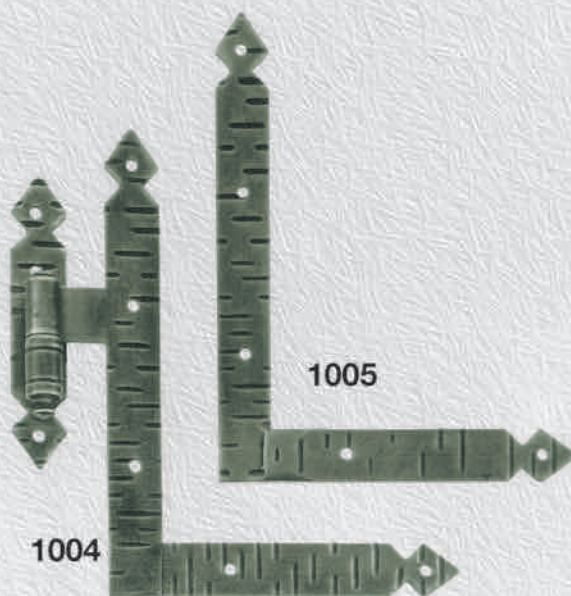

1004

1005

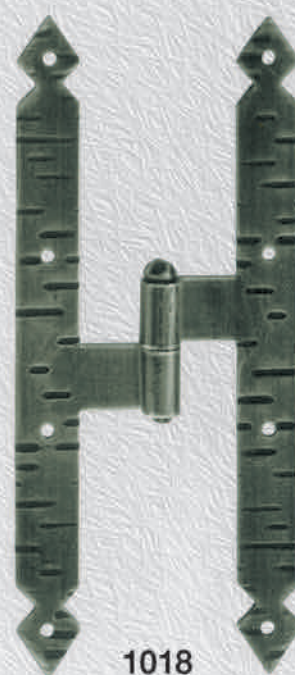

1018

Gli articoli rappresentati sono sinistri

BANDELLE - BANDELLE A SQUADRA SQUADRE DI RINFORZO

* Specificare se destra o sinistra.

A richiesta zanca a murare, cardine a vite (vedi pag. 39)

- Art. 1001/A - bandella mm 200x20x3 - cardine a legno mm 120x20x3 ø 10
- battuta mm 15
- Art. 1001/B - bandella mm 250x30x3 - cardine a legno mm 160x30x4 ø 12
- battuta mm 18
- Art. 1001/C - bandella mm 300x30x3 - cardine a legno mm 160x30x4 ø 12
- battuta mm 18
- Art. 1001/D - bandella mm 350x40x4 - cardine a legno mm 190x40x5 ø 14
- battuta mm 22
- Art. 1001/E - bandella mm 400x40x4 - cardine a legno mm 190x40x5 ø 14
- battuta mm 22
- Art. 1003/A - bandella a "T" mm 250x30x3 - cardine a legno mm 160x30x4 ø 12
- distanza sui centri mm 55 - battuta mm 18
- Art. 1003/B - bandella a "T" mm 300x30x3 - cardine a legno mm 160x30x4 ø 12
- distanza sui centri mm 55 - battuta mm 18

- Art. 1003/C - bandella a "T" mm 400x40x4 - cardine a legno mm 190x40x5 ø 14
- distanza sui centri mm 75 - battuta mm 22

- Art. 1002/A - bandella doppia mm 400x30x3

- Art. 1002/C - bandella doppia mm 600x40x4

- Art. 1005/A* - squadra rinforzo mm 180x130x20x3

- Art. 1005/B* - squadra rinforzo mm 250x200x30x3

- Art. 1005/C* - squadra rinforzo mm 300x250x30x3

- Art. 1005/D* - squadra rinforzo mm 400x350x40x4

- Art. 1004/A* - bandella a squadra mm 180x130x20x3 - cardine a legno mm 120x20x3 ø 10
- distanza sui centri mm 35 - battuta mm 15

- Art. 1004/B* - bandella a squadra mm 250x200x30x3 - cardine a legno mm 160x30x4 ø 12
- distanza sui centri mm 55 - battuta mm 18

- Art. 1004/C* - bandella a squadra mm 300x250x30x3 - cardine a legno mm 160x30x4 ø 12
- distanza sui centri mm 55 - battuta mm 18

- Art. 1004/D* - bandella a squadra mm 400x350x40x4 - cardine a legno mm 190x40x5 ø 14
- distanza sui centri mm 75 - battuta mm 22

- Art. 1018/A* - bandella a "T" doppia mm 250x30x3 - distanza sui centri mm 70

- Art. 1018/B* - bandella a "T" doppia mm 300x30x3 - distanza sui centri mm 70

- Art. 1018/C* - bandella a "T" doppia mm 400x40x4 - distanza sui centri mm 100



46



45

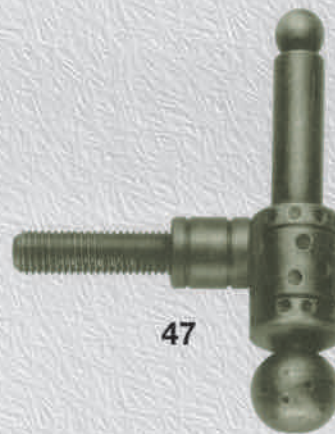

47



48



51



52

CARDINI PER BANDELLE - A LEGNO - A VITE ZANCHE A MURARE

A RICHIESTA CARDINI A FILO

- Art. 46/10 - cardine a legno perno \varnothing mm 10
- 46/12 - perno \varnothing mm 12
- 46/14 - perno \varnothing mm 14
- Art. 45/10 - cardine a legno perno \varnothing mm 10
- 45/12 - perno \varnothing mm 12
- 45/14 - perno \varnothing mm 14
- 45/16 - perno \varnothing mm 16
- Art. 47/10 - cardine a vite perno \varnothing mm 10 - vite 8 MA
- 47/12 - perno \varnothing mm 12 - vite 10 MA
- 47/14 - perno \varnothing mm 14 - vite 12 MA

- Art. 48/10 - zanca a murare perno \varnothing mm 10
- 48/12 - perno \varnothing mm 12
- 48/14 - perno \varnothing mm 14
- 48/16 - perno \varnothing mm 16
- Art. 51/10 - cardine a vite perno \varnothing mm 10 - vite 8 MA
- 51/12 - perno \varnothing mm 12 - vite 10 MA
- 51/14 - perno \varnothing mm 14 - vite 12 MA
- Art. 52/10 - zanca a murare perno \varnothing mm 10
- 52/12 - perno \varnothing mm 12
- 52/14 - perno \varnothing mm 14



600



601



590



590/F



591



591/F



CERNIERE PER PORTE E FINESTRE

- Art. 600 - cerniera doppia mm 270x200x2,5
- Art. 601/A - cerniera doppia mm 160x130x2
- Art. 601/B - cerniera doppia mm 200x140x2
- Art. 590 - cerniera mm 270x100x2,5 - piastra mm 175x25x4 - battuta mm 18
- Art. 590/F - cerniera finta mm 270x85x2,5
- Art. 591/A - cerniera mm 160x60x2 - piastra mm 120x20x3 - battuta mm 15
- Art. 591/B - cerniera mm 200x70x2 - piastra mm 130x20x3 - battuta mm 15
- Art. 591A/F - cerniera finta mm 160x50x2
- Art. 591B/F - cerniera finta mm 200x65x2



592



602

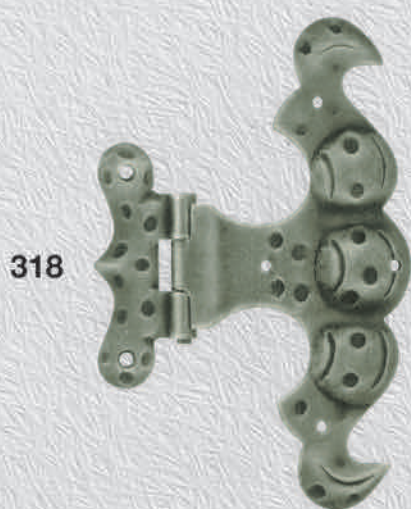

318



602/A



318/F



602/F

CERNIERE PER PORTE E FINESTRE

- Art. 592** - cerniera mm 250x120x2,5 - piastra mm 130x25x5 - battuta mm 18
- Art. 602** - cerniera doppia mm 145x110x2
- Art. 318** - cerniera mm 175x80x2 - piastra mm 90x35x2 - battuta mm 10
- Art. 602/A** - cerniera mm 145x60x2 - piastra mm 135x20x3 - battuta mm 15
- Art. 318/F** - cerniera finta mm 175x75x2
- Art. 602/F** - cerniera finta mm 145x50x2

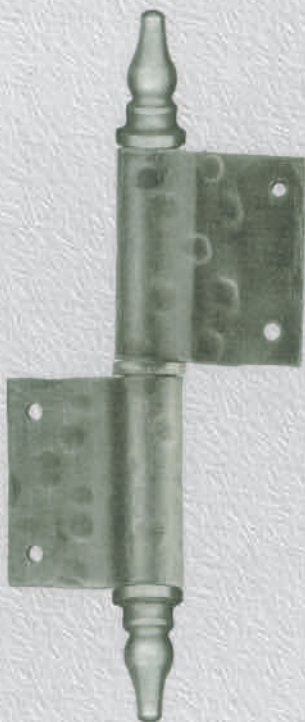

1019

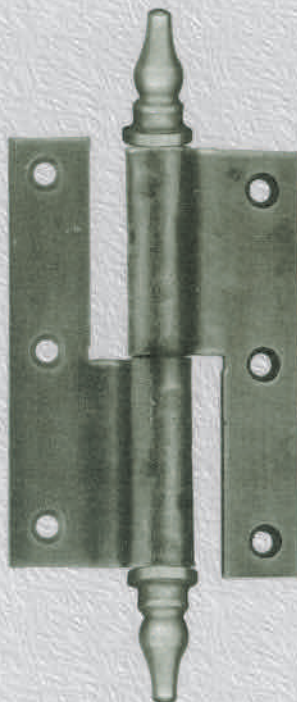

547 Sinistra

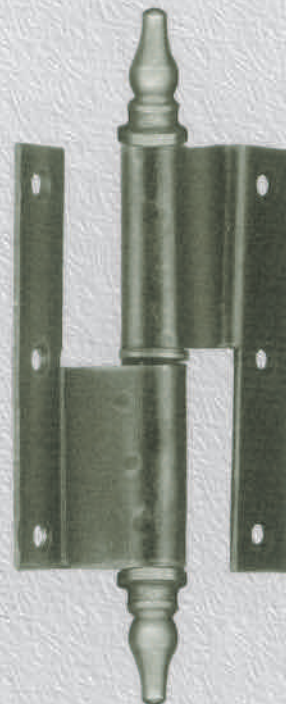

546 Sinistra

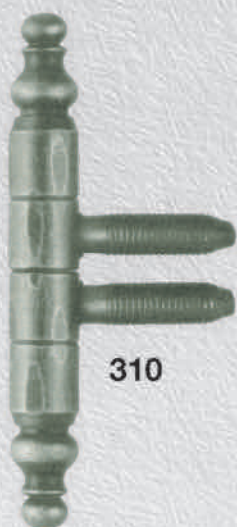

310



311



312



CERNIERE A VITE PAUMELLE PER PORTE E FINESTRE

* Specificare se destra o sinistra.

- Art. 1019/A - cerniera francese mm 100x65x2
- Art. 1019/B - cerniera francese mm 120x70x2
- Art. 547/A* - paumelle piana mm 100x65x2
- Art. 547/B* - paumelle piana mm 120x70x2
- Art. 546/A* - paumelle piegata mm 100x65x2
- Art. 546/B* - paumelle piegata mm 120x70x2
- Art. 310 - cerniera a vite o mm 11x80
- Art. 311 - cerniera a vite o mm 14x100
- Art. 312 - cerniera a vite o mm 16x110

**ACCESSORI PER ARREDAMENTO,
ATTACCAPANNI.**



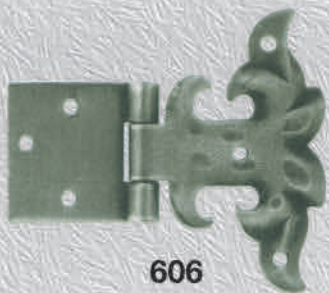

606



606/A



606/B



619



619/B



619/A



615



727



599



597



597/A



597/B



597/F



CERNIERE PER MOBILI

- Art. 606 - cerniera mm 75x50x1,5 - piastra mm 35x35x1,5
- Art. 606/A - cerniera mm 75x50x1,5 - piastra mm 85x18x3 - battuta mm 15
- Art. 606/B - cerniera mm 75x50x1,5 - cardine a vite
- Art. 619 - cerniera mm 110x40x1,5- piastra mm 35x35x1,5
- Art. 619/A - cerniera mm 110x40x1,5- cardine a vite

- Art. 619/B - cerniera mm 110x40x1,5- piastra mm 85x18x3- battuta mm 12
- Art. 615/A - cerniera doppia mm 75x50x1,5
- Art. 615/B - cerniera doppia mm 100x65x1,5
- Art. 727 - cerniera mm 55x35x1,5- piastra mm 55x15x1,5- battuta mm 12
- Art. 599 - cerniera doppia mm 90x55x1,5
- Art. 597 - cerniera mm 115x40x1,5- piastra mm 45x30x1,5
- Art. 597/A - cerniera mm 115x40x1,5- cardine a vite
- Art. 597/B - cerniera mm 115x40x1,5- piastra mm 85x18x3- battuta mm 15
- Art. 597/F - cerniera finta mm 115x40x1,5



598

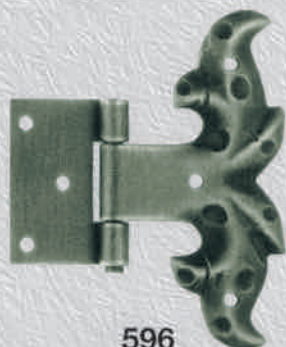

596
726



596/A



596/B



594
728/B



594/A
728/A



594/B
728
595



594/F
728/F



98



310

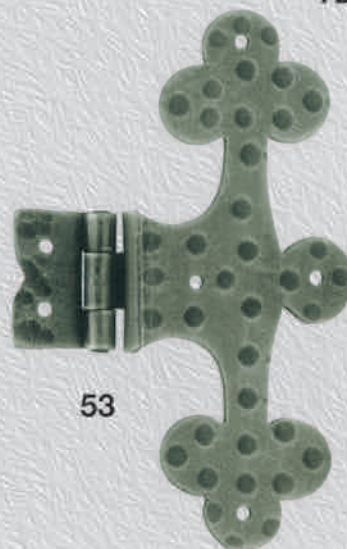

53

CERNIERE PER MOBILI

Art. 598 - cerniera doppia mm 95x65x1,5

Art. 596 - cerniera mm 95x50x1,5 - piastra mm 45x30x1,5

Art. 726 - cerniera mm 70x35x1,5 - piastra mm 35x35x1,5

Art. 596/A - cerniera mm 95x50x1,5 - cardine a vite

Art. 596/B - cerniera mm 95x50x1,5 - piastra mm 85x18x3 - battuta mm 10

Art. 594 - cerniera mm 80x40x1,5 - piastra mm 85x18x3 - battuta mm 15

Art. 728/B - cerniera mm 100x55x2 - piastra mm 85x18x3 - battuta mm 15

Art. 594/A - cerniera mm 80x40x1,5 - cardine a vite

Art. 728/A - cerniera mm 100x55x2 - cardine a vite

Art. 594/B - cerniera mm 80x40x1,5 - piastra mm 35x35x1,5

Art. 728 - cerniera mm 100x55x2 - piastra mm 45x30x1,5

Art. 595 - cerniera mm 160x75x2 - piastra mm 45x30x1,5

Art. 594/F - cerniera finta mm 80x30x1,5

Art. 728/F - cerniera finta mm 100x40x2

Art. 98 - cerniera mm 110x65x2 - piastra mm 40x100x1,5

Art. 310 - cerniera a vite ø mm 11x80

Art. 53 - cerniera mm 140x75x2 - piastra mm 35x30x1,5



334



729



605



700



607



1030



1031



1036



1033



1032



1034



CERNIERE PER MOBILI E CASSAPANCA

- | | | | | | |
|-----------------|---------------------------------|-------------------------|------------------|------------------------------------|-------------------------|
| Art. 334 | - cerniera mm 215x55x2 | - piastra mm 40x100x1,5 | Art. 605 | - cerniera mm 120x85x1,5 | - piastra mm 40x100x1,5 |
| Art. 729 | - cerniera doppia mm 100x70x1,5 | | Art. 700 | - cerniera mm 185x55x2 | - piastra mm 35x90x2 |
| | | | Art. 607 | - cerniera mm 160x70x2 | - piastra mm 50x95x2 |
| | | | Art. 1030 | - cerniera mm 70x40x2 | - piastra mm 35x70x1,5 |
| | | | Art. 1031 | - cerniera mm 110x55x2 | - piastra mm 50x95x2 |
| | | | Art. 1036 | - squadra rinforzo mm 100x100x20x3 | |
| | | | Art. 1034 | - cantonale rinforzo mm 85x85x20x1 | |
| | | | Art. 1033 | - cerniera mm 120x85x1,5 | - piastra mm 40x100x1,5 |
| | | | Art. 1032 | - cerniera mm 135x60x2 | - piastra mm 35x90x2 |



1057

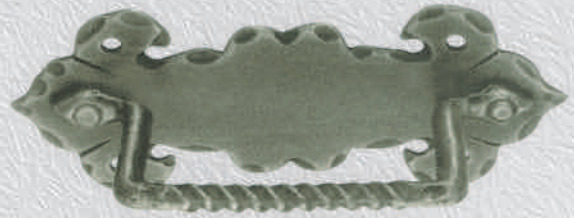

337



660



697



661



698



664

MANIGLIE PER MOBILI

- Art. 1057 - maniglia mm 115xø 12 - piastra mm 200x45x3
 Art. 337 - maniglia mm 70x30xø 7 - piastra mm 110x45x1,5

- Art. 660/A - maniglia mm 85xø 10 - rosette ø mm 30x1,5
 Art. 660/B - maniglia mm 120xø 12 - rosette ø mm 35x1,5
 Art. 697 - maniglia mm 125xø 10 - rosette ø mm 40x1,5
 Art. 661/A - maniglia mm 85xø 10 - piastra mm 40x40x1,5
 Art. 661/B - maniglia mm 120xø 12 - piastra mm 55x55x1,5
 Art. 698 - maniglia mm 190x12x12 - piastra mm 55x55x1,5
 Art. 664/A - maniglia mm 100xø 7
 Art. 664/B - maniglia mm 130xø 8
 Art. 664/C - maniglia mm 180xø 12



336



621



531



616



530



54



1055/A



523



618



1055



681



684



617



617/A



682



680



618/B



683



525/A

POMOLI - PENDENTI E BOCCHETTE PER MOBILI

- Art. 336 - pendente mm 55x ø 8 - piastra mm 50x22x1,5
- Art. 621/A - pendente mm 60x ø 8 - piastra mm 40x40x1,5
- Art. 621/B - pendente mm 80x ø 10 - piastra mm 55x55x1,5
- Art. 531 - pomolo ø mm 42x1,5 vite passante
- Art. 530 - pomolo ø mm 35x2 vite passante
- Art. 616 - pomolo ø mm 35x1,5 - piastra mm 85x35x1,5
- Art. 54 - pendente ø mm 45x5 vite passante
- Art. 1055/A - pendente mm 42x45x5 vite passante
- Art. 523/A - pendente ø mm 35x ø 4 - rosetta ø mm 35x1,5 vite passante
- Art. 523/B - pendente ø mm 40x ø 5 - rosetta ø mm 35x1,5 vite passante

- Art. 523/C - pendente ø mm 55x ø 6 - rosetta ø mm 42x1,5 vite passante
- Art. 618 - pendente ø mm 42x ø 7 - piastra mm 30x30x1,5 vite passante
- Art. 1055 - pendente mm 42x45x5 - piastra mm 40x40x1,5
- Art. 681 - bocchetta mm 30x55x1,5
- Art. 684 - bocchetta mm 55x30x1,5
- Art. 617 - bocchetta mm 85x35x1,5
- Art. 617/A - bocchetta mm 35x85x1,5
- Art. 682 - bocchetta mm 55x30x1,5
- Art. 680 - bocchetta mm 30x55x1,5
- Art. 618/B - bocchetta mm 30x30x1,5
- Art. 683 - bocchetta ø mm 40x1,5
- Art. 525/A - bocchetta mm 40x40x1,5





1056



305



524



691



690



689



687



688



705



704



703



702



705/A



704/A



703/A



702/A

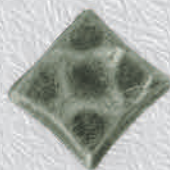

695



694



898/A



898/B

POMOLI - TESTE PER CHIAVI - CHIODI

- Art. 1056 - pomolo ø mm 30 - piastra mm 50x23x1,5
- Art. 305/A - pendente ø mm 70xø 12 - piastra mm 40x40x1,5
- Art. 305/B - pendente ø mm 80xø 15 - piastra mm 50x50x1,5
- Art. 524/A - pomolo ø mm 30 - piastra mm 40x40x1,5
- Art. 524/B - pomolo ø mm 40 - piastra mm 50x50x1,5
- Art. 691 - testa per chiave mm 40x35
- Art. 690 - testa per chiave mm 45x35
- Art. 689 - testa per chiave mm 40x30
- Art. 687 - testa per chiave mm 45x30
- Art. 688 - testa per chiave mm 45x30

- Art. 705 - chiodo a borchia mm 30x30 - a 2 punte mm 12
- Art. 704 - chiodo a borchia mm 25x25 - a 2 punte mm 12
- Art. 703 - chiodo a borchia mm 19x19 - a 2 punte mm 12
- Art. 702 - chiodo a borchia mm 13x13 - a 2 punte mm 12
- Art. 705/A - chiodo mm 30x30 - a 1 punta mm 25
- Art. 704/A - chiodo mm 25x25 - a 1 punta mm 23
- Art. 703/A - chiodo mm 19x19 - a 1 punta mm 20
- Art. 702/A - chiodo mm 13x13 - a 1 punta mm 15
- Art. 695 - chiodo massiccio mm 30x30 - a 1 punta mm 30
- Art. 694 - chiodo massiccio mm 25x25 - a 1 punta mm 25
- Art. 898/A - borchia copridado mm 25x25 - a 2 punte mm 12
- Art. 898/B - borchia copridado mm 20x20 - a 2 punte mm 12



706



787



785



786



436



1008



435



177



1037



56



57

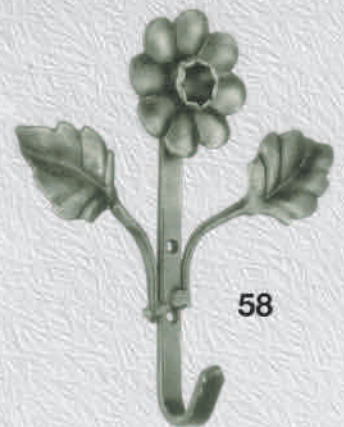

58



784



783



1038



55



ATTACCAPANNI - APPENDIABITI

- Art. 706 - attaccapanni mm 180x110
- Art. 787 - attaccapanni mm 250x120 - piastra mm 70x35
- Art. 785 - appendiabiti mm 200x60
- Art. 786 - appendiabiti mm 200x60 - piastra mm 110x110
- Art. 436 - attaccapanni mm 250x110
- Art. 1008 - appendiabiti mm 130x110 - piastra mm 55x55

- Art. 435 - attaccapanni mm 270x160
- Art. 177 - attaccapanni mm 160x130 - rosetta ø mm 80
- Art. 1037 - appendiabiti mm 220x60
- Art. 56 - appendiabiti mm 150x150
- Art. 57 - gancio mm 120x120
- Art. 58 - gancio mm 120x120
- Art. 784 - gancio mm 80x60
- Art. 783 - gancio mm 80x30
- Art. 1038 - gancio mm 80x60
- Art. 55 - gancio mm 58x30



724/1

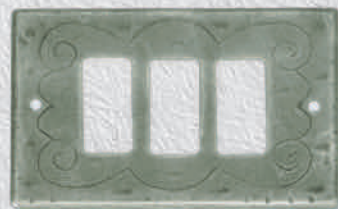

724/3

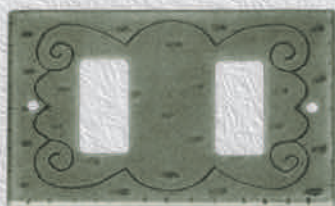

724/2



724/4



724

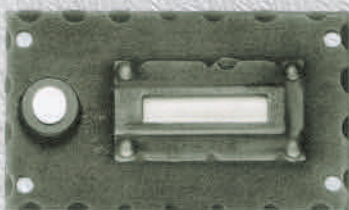

623

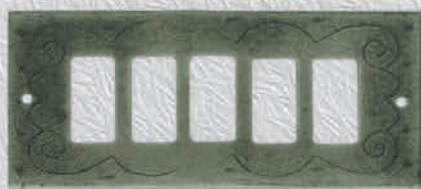

724/5

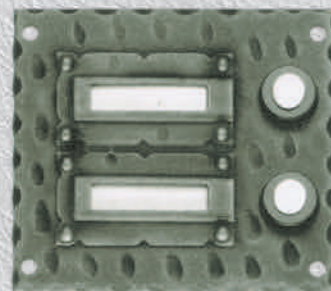

624



625



1068



1070



1069

COPRINTERRUTTORI - CAMPANELLI

- Art. 724/1 - coprinterruttore mm 115x70 serie magic
- Art. 724/2 - coprinterruttore mm 115x70 serie magic
- Art. 724/3 - coprinterruttore mm 115x70 serie magic

- Art. 724/4 - coprinterruttore mm 140x70 serie magic
- Art. 724/5 - coprinterruttore mm 160x70 serie magic
- Art. 724 - coprinterruttore mm 115x70 serie magic
- Art. 623 - piastra con campanello e portanome mm 100x60
- Art. 624 - piastra con campanello e portanomi mm 100x90
- Art. 625 - piastra per lettere con campanello e portanome mm 330x70
- buca mm 200x30
- Art. 1068 - rosetta ø mm 60 con campanello
- Art. 1070 - rosetta ø mm 50 con campanello
- Art. 1069 - piastra con campanello mm 75x75



1098



1097



1096



996

MENSOLE PIANE

- Art. 1098 - mensola mm 210x35x5x145 sporgenza
- Art. 1097 - mensola mm 235x35x5x220 sporgenza
- Art. 1096 - mensola mm 270x25x4x200 sporgenza
- Art. 996/A - mensola mm 150x20x4x200 sporgenza
- Art. 996/B - mensola mm 200x20x4x250 sporgenza
- Art. 996/C - mensola mm 250x25x4x300 sporgenza
- Art. 996/D - mensola mm 300x30x5x350 sporgenza



627
628
1009
1009/A



629
630



876
877



1007
1007/A

MENSOLE PIANE - MENSOLE CON GANCIO

- Art. 627 - mensola mm 110x20x3x150 sporgenza
- Art. 628 - mensola mm 100x20x3x100 sporgenza
- Art. 1009 - mensola mm 200x20x3x250 sporgenza
- Art. 1009/A - mensola mm 150x20x3x200 sporgenza
- Art. 629 - mensola con gancio mm 290x70x4x300 sporgenza
- Art. 630 - mensola con gancio mm 190x50x4x170 sporgenza
- Art. 876 - mensola con gancio mm 260x80x3x250 sporgenza
- Art. 877 - mensola con gancio mm 260x80x3x300 sporgenza
- Art. 1007 - mensola con gancio mm 140x50x2x260 sporgenza
- Art. 1007/A - mensola con gancio mm 140x50x2x160 sporgenza



1061



1062



1058



1066



1067



922



1059



920



921



923

GANCI A VITE - CATENA



* Catena: finitura verniciata nero opaco

- Art. 1061 - gancio mm 50 vite legno - rosetta mm 55x55x2
- Art. 1062 - gancio mm 50 vite legno - rosetta ø mm 50x2
- Art. 1058* - catena saldata maglia mm 160x60xø 10
- Art. 1066* - catena non saldata maglia ø mm 50xø 6
- Art. 1067* - catena non saldata maglia mm 70xø 6
- Art. 922* - catena non saldata maglia mm 70x ø 6
- Art. 1059* - catena non saldata pesante maglia mm 180x85xø 14
- Art. 920* - catena non saldata maglia mm 100xø 5
- Art. 921* - catena non saldata maglia mm 60xø 3,5
- Art. 923* - catena non saldata maglia mm 50xø 4

**RILOGHE, SCORRITENDA,
ACCESSORI PER TENDE.**



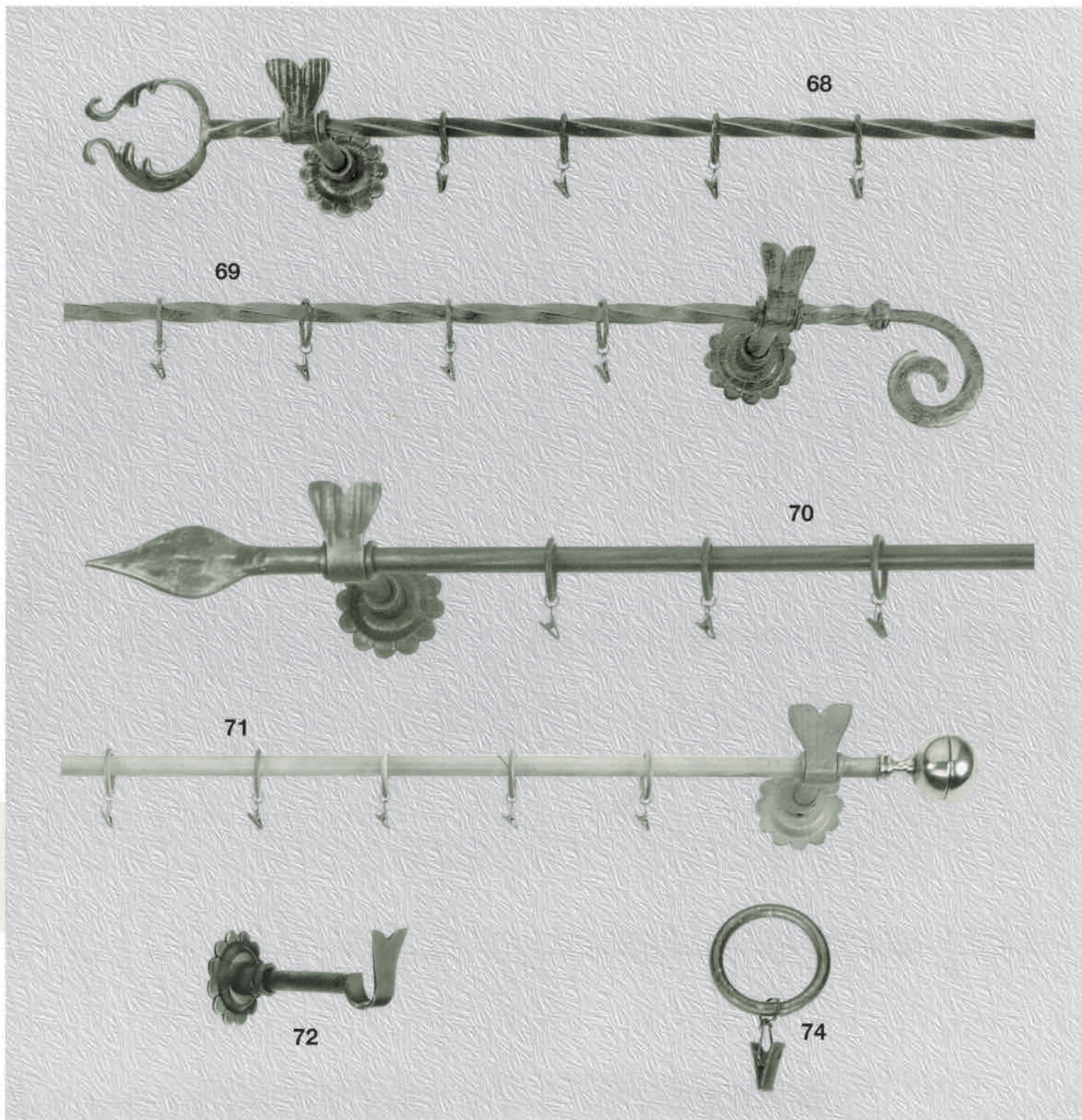

RILOGHE - SCORRITENDA MOVIMENTO A STRAPPO

Finiture disponibili: nero antico - avorio antico - verde oro antico
rosso antico - oro antico

- Art. 68/A** - scorritenda completo cm 184
- asta cm 160 - tubo ∇ ritorto \varnothing mm 17 + finali cm 24
- sporgenza cm 15 + 16 anelli con pinza
- Art. 68/B** - scorritenda completo cm 224
- asta cm 200 - tubo ∇ ritorto \varnothing mm 17 + finali cm 24
- sporgenza cm 15 + 20 anelli con pinza
- Art. 68/C** - scorritenda completo cm 274
- asta cm 250 - tubo ∇ ritorto \varnothing mm 17 + finali cm 24
- sporgenza cm 15 + 25 anelli con pinza
- Art. 69/A** - scorritenda completo cm 182
- asta cm 160 - tubo ∇ ritorto \varnothing mm 17 + finali cm 22
- sporgenza cm 15 + 16 anelli con pinza
- Art. 69/B** - scorritenda completo cm 222
- asta cm 200 - tubo ∇ ritorto \varnothing mm 17 + finali cm 22
- sporgenza cm 15 + 20 anelli con pinza
- Art. 69/C** - scorritenda completo cm 272
- asta cm 250 - tubo ∇ ritorto \varnothing mm 17 + finali cm 22
- sporgenza cm 15 + 25 anelli con pinza

- Art. 70/A** - scorritenda completo cm 192
- asta cm 160 - tubo liscio \varnothing mm 17 + finali cm 32
- sporgenza cm 15 + 16 anelli con pinza
- Art. 70/B** - scorritenda completo cm 232
- asta cm 200 - tubo liscio \varnothing mm 17 + finali cm 32
- sporgenza cm 15 + 20 anelli con pinza
- Art. 70/C** - scorritenda completo cm 282
- asta cm 250 - tubo liscio \varnothing mm 17 + finali cm 32
- sporgenza cm 15 + 25 anelli con pinza
- Art. 71/A** - scorritenda completo cm 178
- asta cm 160 - tubo liscio \varnothing mm 17 + finali cm 18
- sporgenza cm 15 + 16 anelli con pinza
- Art. 71/B** - scorritenda completo cm 218
- asta cm 200 - tubo liscio \varnothing mm 17 + finali cm 18
- sporgenza cm 15 + 20 anelli con pinza
- Art. 71/C** - scorritenda completo cm 268
- asta cm 250 - tubo liscio \varnothing mm 17 + finali cm 18
- sporgenza cm 15 + 25 anelli con pinza
- Art. 72** - supporto per riloghe - rosetta cm 8 x 15 sporgenza
- Art. 74** - anello in ferro \varnothing mm 35 con pinza reggitenda

NB: I supporti laterali sono separati dall'asta. Tagliando l'estremità dell'asta si può ottenere la lunghezza desiderata

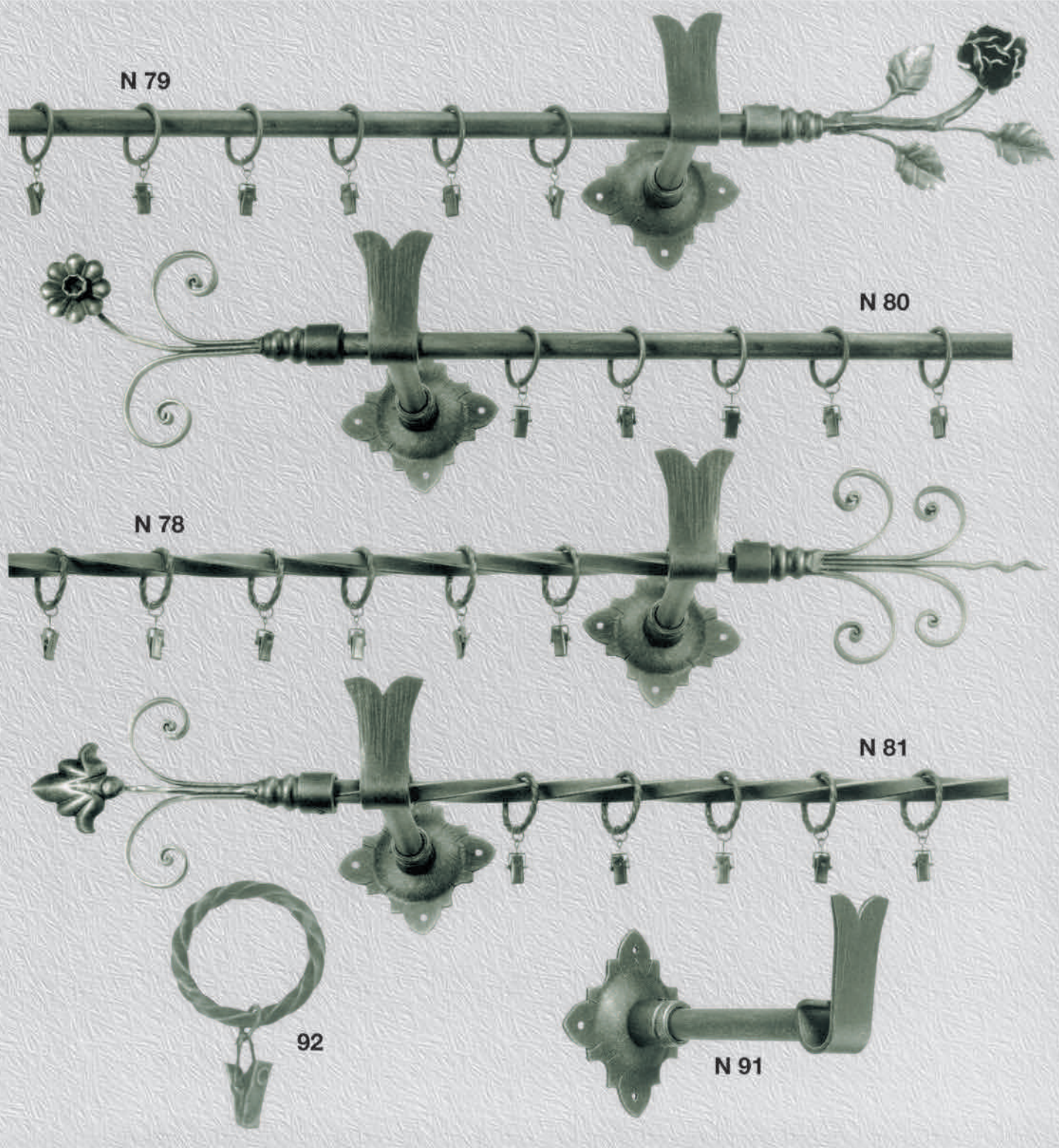

RILOGHE - SCORRITENDA MOVIMENTO A STRAPPO

Finiture disponibili: nero antico - avorio antico - verde oro antico
rosso antico - oro antico

- Art. N 78/A** - scorritenda completo cm 198 - asta cm 160
- tubo \varnothing ritorto \varnothing mm 17 + finali cm 38 - sporgenza cm 16+16 anelli con pinza
- Art. N 78/B** - scorritenda completo cm 238 - asta cm 200
- tubo \varnothing ritorto \varnothing mm 17 + finali cm 38 - sporgenza cm 16+20 anelli con pinza
- Art. N 78/C** - scorritenda completo cm 288 - asta cm 250
- tubo \varnothing ritorto \varnothing mm 17 + finali cm 38 - sporgenza cm 16+25 anelli con pinza
- Art. N 81/A** - scorritenda completo cm 196 - asta cm 160
- tubo \varnothing ritorto \varnothing mm 17 + finali cm 36 - sporgenza cm 16+16 anelli con pinza
- Art. N 81/B** - scorritenda completo cm 236 - asta cm 200
- tubo \varnothing ritorto \varnothing mm 17 + finali cm 36 - sporgenza cm 16+20 anelli con pinza
- Art. N 81/C** - scorritenda completo cm 286 - asta cm 250
- tubo \varnothing ritorto \varnothing mm 17 + finali cm 36 - sporgenza cm 16+25 anelli con pinza

- Art. N 79/A** - scorritenda completo cm 194 - asta cm 160
- tubo liscio \varnothing mm 17 + finali cm 34 - sporgenza cm 16+16 anelli con pinza
- Art. N 79/B** - scorritenda completo cm 234 - asta cm 200
- tubo liscio \varnothing mm 17 + finali cm 34 - sporgenza cm 16+20 anelli con pinza
- Art. N 79/C** - scorritenda completo cm 284 - asta cm 250
- tubo liscio \varnothing mm 17 + finali cm 34 - sporgenza cm 16+25 anelli con pinza
- Art. N 80/A** - scorritenda completo cm 196 - asta cm 160
- tubo liscio \varnothing mm 17 + finali cm 36 - sporgenza cm 16+16 anelli con pinza
- Art. N 80/B** - scorritenda completo cm 236 - asta cm 200
- tubo liscio \varnothing mm 17 + finali cm 36 - sporgenza cm 16+20 anelli con pinza
- Art. N 80/C** - scorritenda completo cm 286 - asta cm 250
- tubo liscio \varnothing mm 17 + finali cm 36 - sporgenza cm 16+25 anelli con pinza
- Art. N 91** - supporto per riloga - rosetta cm 10,5x16 sporgenza
- Art. 92** - anello in ferro ritorto \varnothing mm 35 con pinza reggitenda

NB: I supporti laterali sono separati dall'asta. Tagliando l'estremità dell'asta s ottenere la lunghezza desiderata

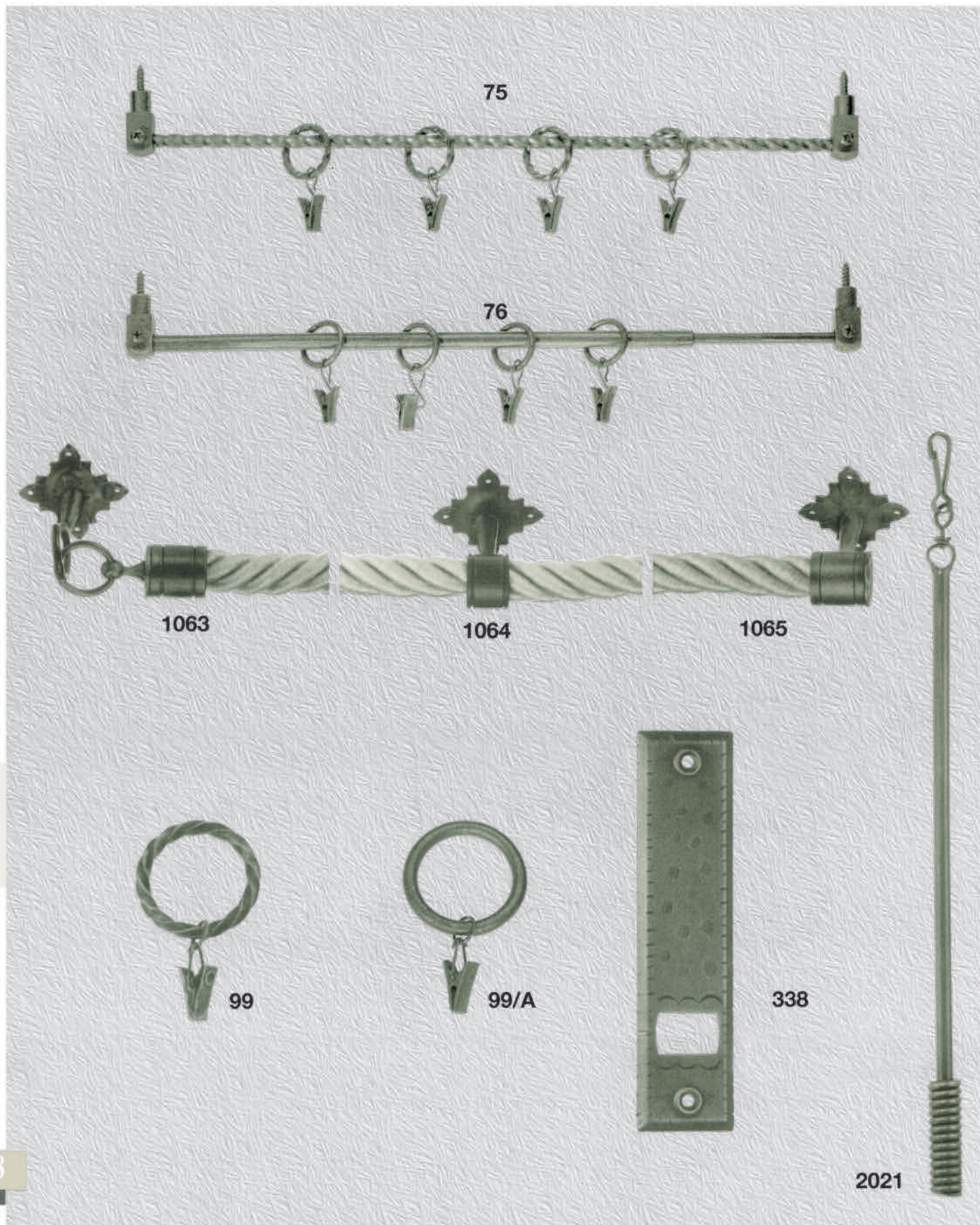

**SCORRITENDA MOVIMENTO A STRAPPO
REGGICORDONI - COPRIAVVOLGIBILE**

* Finiture disponibili: nero antico - avorio antico - verde oro antico
rosso antico - oro antico

- Art. 75/A*** - scorritenda cm 50
- quadro ritorto \varnothing mm 6 - sporgenza mm 20 + 5 anelli con pinza
- Art. 75/B*** - scorritenda cm 60
- quadro ritorto \varnothing mm 6 - sporgenza mm 20 + 6 anelli con pinza
- Art. 75/C*** - scorritenda cm 40 estensibile a cm 55
- tubo liscio \varnothing mm 10 - sporgenza mm 20 + 5 anelli con pinza

- Art. 76/B*** - scorritenda cm 50 estensibile a cm 65
- tubo liscio \varnothing mm 10 - sporgenza mm 20 + 6 anelli con pinza
- Art. 1063** - reggicordone con gancio "per cordone \varnothing mm 25"
- sporgenza mm 90 - piastra mm 75x75x2
- Art. 1064** - reggicordone passante \varnothing mm 25
- sporgenza mm 90 - piastra mm 75x75x2
- Art. 1065** - reggicordone finale \varnothing mm 25
- sporgenza mm 90 - piastra mm 75x75x2
- Art. 99*** - anello in ferro ritorto \varnothing mm 25 con pinza reggitenda
- Art. 99/A*** - anello in ferro \varnothing mm 25 con pinza reggitenda
- Art. 338** - copriavvolgibile universale per tapparelle mm 55x215x2 foro 35x20
- Art. 2021*** - frusta per rilogia lunghezza cm 135



**CASSETTE E BUCHE PER LETTERE,
NUMERI CIVICI.
PARTICOLARI PER COMPOSIZIONI
ORNAMENTALI IN FERRO BATTUTO.**



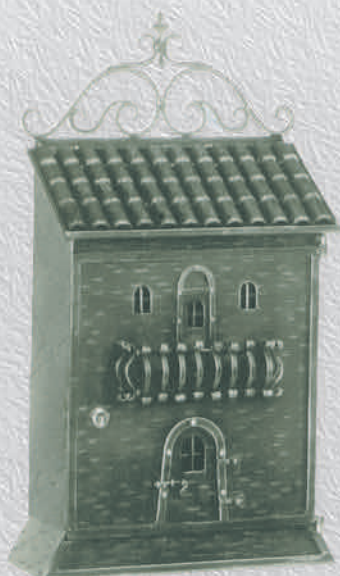

868



988

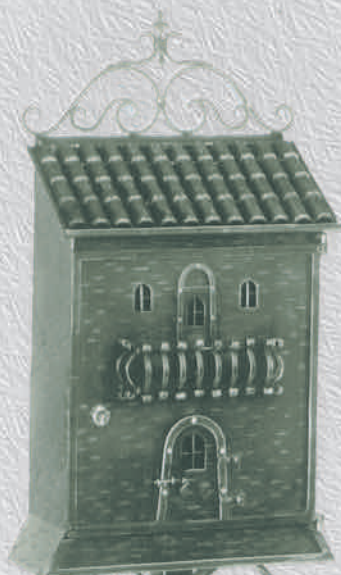

869



1084



**CASSETTE PER LETTERE A PIANTANA
CASSETTE PER LETTERE A MURO**

- Art. 868** - cassetta per lettere a muro mm 480x450x150 profondità
- Art. 988** - cassetta per lettere a muro mm 400x320x150 profondità
- Art. 869** - cassetta per lettere mm 600x350x160 profondità
- piantana a murare mm 900x40x40
- Art. 1084** - cassetta per lettere mm 450x350x430 profondità con contenitore pane
- piantana a murare mm 900x40x40



440



810



1076

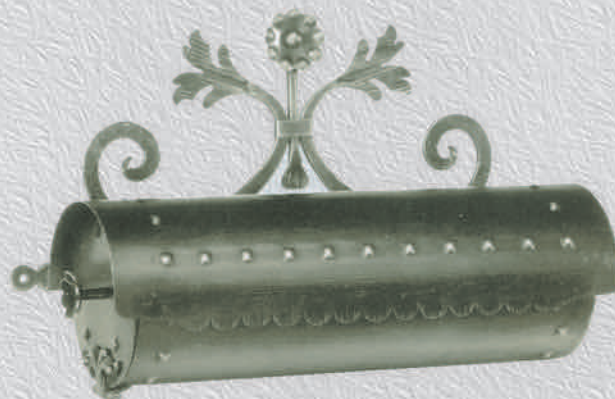

989

CASSETTE PER LETTERE - PORTAGIORNALI

- Art. 440 - cassetta per lettere a muro mm 480x450x150 profondità
- Art. 810 - cassetta per lettere a muro mm 400x300x130 profondità
- Art. 1076 - cassetta per lettere a muro mm 330x230x100 profondità
- Art. 989 - portagiornali e stampe a muro mm 450x270xø mm 130



894/0 894/1 894/2 894/3



894/4 894/5 894/6



894/7 894/8 894/9

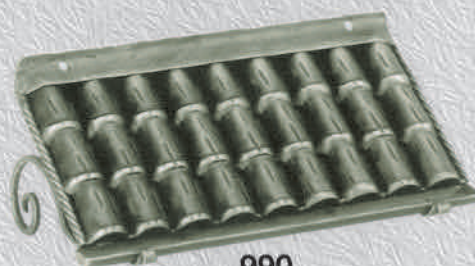

990



626



625

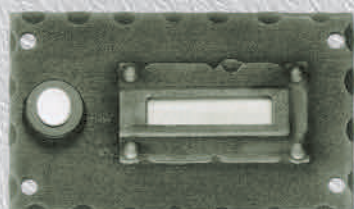

623

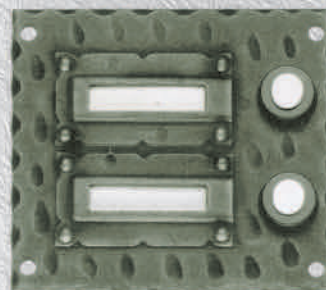

624



1068



1070



1069

NUMERI CIVICI - BUCHE PER LETTERE ROSETTE CON CAMPANELLO

- Art. 894/0 - numero arabo mm 160x8
- Art. 894/1 - numero arabo mm 160x8
- Art. 894/2 - numero arabo mm 160x8
- Art. 894/3 - numero arabo mm 160x8
- Art. 894/4 - numero arabo mm 160x8
- Art. 894/5 - numero arabo mm 160x8
- Art. 894/6 - numero arabo mm 160x8
- Art. 894/7 - numero arabo mm 160x8

- Art. 894/8 - numero arabo mm 160x8
- Art. 894/9 - numero arabo mm 160x8
- Art. 990 - tetto protezione per citofono mm 260x100x100 sporgenza
- Art. 626 - piastra per lettere mm 290x70 - buca mm 200x30 con portanom e campanello
- Art. 625 - piastra per lettere mm 330x70 - buca mm 200x30 con portanom e campanello
- Art. 623 - piastra con portanome con campanello mm 100x60
- Art. 624 - piastra con portanomi con campanelli mm 100x90
- Art. 1068 - rosetta con campanello ø mm 60
- Art. 1070 - rosetta con campanello ø mm 50
- Art. 1069 - piastra con campanello mm 75x75





2012



2011



2010



25/S



21/S



21/D



37/S



37/D

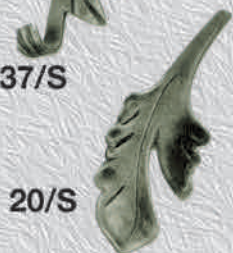

20/S



20/D



26/D
27/D



2005



28/S

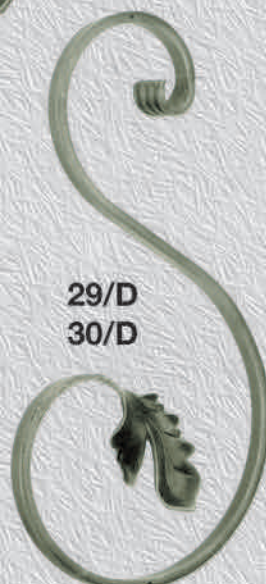

29/D
30/D



2008 2009

S= sinistro/D= destro

PARTICOLARI PER COMPOSIZIONI ORNAMENTALI IN FERRO BATTUTO GREZZO

* Specificare se destro o sinistro

Art. 2012	- pannello mm 320x320	- materiale	∅ mm 12
Art. 2011	- pannello mm 530x420	- materiale	mm 15x8
Art. 2010	- pannello ø mm 450	- materiale	∅ mm 12
Art. 25*	- motivo mm 200x12	- materiale	mm 15x5
Art. 21*	- foglia mm 80x70x3		

Art. 26*	- motivo mm 300x190	- materiale	mm 15x8
Art. 27*	- motivo mm 350x230	- materiale	mm 15x8
Art. 37*	- foglia mm 115x40x3		
Art. 20*	- foglia mm 170x75x3		
Art. 2005	- elemento cm 100 H	- materiale	mm 15x8
Art. 28*	- motivo mm 200x100	- materiale	mm 15x8
Art. 29*	- motivo mm 300x160	- materiale	mm 15x8
Art. 30*	- motivo mm 400x220	- materiale	mm 15x8
Art. 2008	- asta cm 100 H	- materiale	mm 12x12 martellato
Art. 2009	- asta cm 100 H	- materiale	mm 15x8 ritorto



Condizioni di vendita

1) La nostra Società si riserva il diritto di accettare o rifiutare qualsiasi ordinazione, anche assunta a mezzo di nostri Agenti e Rappresentanti.

2) La nostra Società si riserva il diritto di escludere qualsiasi articolo dalla produzione o di apportare modifiche, senza preavviso, quando ciò si rende necessario per cause di forza maggiore, impreviste esigenze costruttive o per migliorare la qualità degli articoli stessi.

3) La merce viaggia a rischio e pericolo del Committente. Non si assume alcuna responsabilità per furti, manomissioni, avarie, che si dovessero verificare durante il trasporto.

4) Il trasporto sia a mezzo corriere o servizio postale è sempre a carico dell'Acquirente.

5) La nostra società accetta eventuali reclami unicamente se fatti entro 8 giorni dal ricevimento della merce.

6) Eventuali resi di merci devono essere effettuati esclusivamente dopo nostra autorizzazione con le modalità che vi saranno comunicate al momento della richiesta del reso, comunque sempre franco di ogni spesa ai nostri magazzini.

7) Tutti i resi non difettosi verranno da noi ritirati entro 30 giorni dalla data d'acquisto, previa autorizzazione, con l'addebito al cliente del 30% per rimagazzinaggio e riconfezionamento. Non si accettano resi degli articoli non a catalogo o prodotti su specifica richiesta privi di difetti.

8) I termini stabiliti per le consegne hanno solo carattere indicativo. In ogni caso qualsiasi indennità di ritardo data consegna o l'annullamento dell'ordine stesso non potrà mai essere preteso dall'Acquirente.

9) I pagamenti devono essere effettuati presso il domicilio della nostra società: 23868 Valmadrera, via Verdi 10 oppure sul nostro conto bancario: Deutsche Bank s.p.a. filiale Valmadrera, c/c 000000018400 ABI:03104 CAB:51810 SWIFT:DEUTITM1028 CIN:"D" IBAN:IT31D0310451810000000018400

10) Il mancato pagamento anche parziale ci autorizza a sospendere ulteriori invii di merce.

11) Per i ritardi sul pagamento convenuto all'ordinazione saranno conteggiati gli interessi bancari vigenti.

12) Per ogni controversia l'Acquirente riconosce unico foro competente in via esclusiva quello giudiziario di Lecco.

13) Non riconosciamo le condizioni di acquisto degli Acquirenti quando sono in contrasto con le nostre Condizioni di Vendita, a meno che non siano esplicitamente accettate.

14) Qualsiasi difetto o vizio, occulto od apparente, e qualsiasi difformità della merce e materiali venduti fatto salvo il punto 2, daranno all'Acquirente il solo diritto di richiedere la sostituzione, con esclusione assoluta di ogni nostra ipotetica responsabilità per rivalsa di danni diretti e indiretti: in ogni modo questo diritto alla sostituzione dovrà essere esercitato nel termine massimo di 1 mese dalla consegna.

L'Acquirente confermando alla nostra Società un'ordinazione di merce approva e accetta le nostre condizioni di vendita di cui ha preso integrale conoscenza.

Terms and conditions of sale

1) Galbusera reserves the right to accept or to refuse any order even if received through their agents or representatives.

2) Galbusera reserves the right to modify characteristics of the items shown and described in the catalogue, without notice, if this is required for unexpected construction requirements or to improve quality of items themselves.

3) Goods travel at Customer's risk and peril. No responsibility will be taken for any theft, tampering or damage during transit.

4) Transport by carrier or by post is always borne by Customer.

5) All claims must be reported within 8 days from receipt of the shipment.

6) Returns of goods are accepted when authorized by Galbusera according to the conditions that will be notified upon the request of return, in any case ex our warehouse.

7) Any defect, hidden or apparent, of goods and materials sold (except point n. 2), will give to the Customer only the right to require the replacement, with absolute exclusion of our hypothetical liability for compensation of any direct and indirect damages: in any case this right to the replacement must be exercised within a maximum period of 1 month of purchase.

8) Galbusera will accept all non defective returns within 30 days of purchase with the charge to the customer of 30% for re-storage and re-packaging and in any case after Galbusera's official authorization. Special items cannot be returned.

9) Delivery dates are indicative and no liability is accepted for any unforeseen delays or for any consequential loss or damage caused to the customer or third parties as a result of any delays for whatever reason.

10) Payment: the balance due will be paid to our company: 23868 Valmadrera, via Verdi 10 or by bank transfer to : Deutsche Bank s.p.a. branch of Valmadrera, account n. 000000018400 SWIFT:DEUTITM1028 - IBAN: IT31D0310451810000000018400

11) If payment - even partial - is not received, Galbusera will be authorized to stop further shipments of goods.

12) If payment is not received during the time agreed upon, the payment will be subject to bank interests.

13) Any dispute relating to or however in connection with the contracts governed by these general conditions shall be settled by the -court of - Lecco / Italy as the exclusive competent Jurisdiction.

14) Galbusera doesn't not recognize the Terms and Conditions of Purchase of the Customer when they are in conflict with our Terms and Conditions of Sale, unless they are explicitly accepted by both parties.

Customer automatically accepts these Terms & Conditions when confirming purchase order to Galbusera.



Galbusera Giancarlo & Giorgio S.n.C.
premiata fabbrica ferro battuto d'arte - ferramenta

23868 VALMADRERA (LECCO) Italia
Via G. Verdi, 10 - Tel. (0341) 58.12.84 - Fax (0341) 20.10.68
E-mail: galbusera.gg@tin.it